

# Hybrid Off-Road Equipment In-Use Emissions Evaluation

Prepared for:

Mr. Joseph Calavita  
Mr. Hector Maldonado

As part of the FY 2010-11 Air Quality Improvement Project  
Hybrid Off-Road Equipment Pilot Project

California Air Resources Board  
1001 "I" Street  
P.O. Box 2815

June 2013

Submitted by:

Dr. Kent C. Johnson <sup>1</sup>  
Mr. Andrew Burnette <sup>2</sup>  
Mr. Tanfeng Cao (Sam) <sup>1</sup>  
Dr. Robert L. Russell <sup>1</sup>  
Dr. George Scora <sup>1</sup>

<sup>1</sup>University of California  
CE-CERT  
Riverside, CA 92521  
951-781-7586  
951-781-5790 (fax)

<sup>2</sup>infoWedge  
El Dorado Hills, CA 95762  
916-760-8474

## **Disclaimer**

The statements and conclusions in this report are those of the contractor and not necessarily those of the California Air Resources Board. The mention of commercial products, their source, or their use in connection with material reported herein is not to be construed as actual or implied endorsement of such products.

## **Acknowledgments**

This report was prepared at the University of California, Riverside, Bourns College of Engineering-Center for Environmental Research and Technology (CE-CERT). The primary contributors to this report include Kent C. Johnson, Andrew Burnette, Robert L. Russell, Thomas D. Durbin, and Tanfeng (Sam) Cao. The authors thank the following organizations and individuals for their valuable contributions to this project.

We acknowledge the following:

Gary Beerbower, Luke Trickett, Robert Fadden, Boston Mike Williams, maintenance staff, and the equipment operators at Waste Management for assisting the bulldozer testing at Waste Management's El Sobrante Landfill.

We would like to thank William Hunt, Chris McConaughy, Tom Stevens, Mick Riopka, the equipment operators, and the supporting staff at Orange County Water District for assistance on the bulldozer testing at Orange County.

We would like to thank Steve McFarland, Kevin Lough, and the equipment operators at the County of Riverside Transportation Department for assistance on bulldozer testing at Riverside County.

We would like to thank Spencer Defty, the equipment operator, the mechanic, the fabricator, and all the staff support received from Diamond D General Engineering towards activity data collection at the Ft. Hunter Liggett site and emissions testing 4 excavators at Woodland, CA. We also thank Harrison Concrete Cutting for renting their PC220 on short notice for testing at Diamond D.

We would like to thank Dave Kolesky, Jim Harrison, Steve Moore, Steve Kugelman, Steve Branson and all the staff for assistance on the excavator activity testing and for providing a testing unit for emissions testing. And we thank Bali Construction's Foreman Noel Vargas for cooperation and assistance during activity testing on the hybrid rental unit.

We would like to thank Shelli Larson, Jason Williams, Bill Hamel, the staff at Clairemont Equipment Rental, and their contract excavator operator for assistance on the excavator testing and DMI Construction for providing the testing location.

We would like to thank Greg Sheahen, Nathan Cooper, and Michael Fogel at CSM Products for developing and supporting their ECM data logger that was critical in this project.

We would like to thank Joe Schiefer, Eric Gfeller, Dave Van Grouw, Terry Purvis, Eric Johnson, and all the staff at Johnson Machinery for assistance on the bulldozer testing and equipment operational experience.

We would also like to thank the two air districts who supported our proposal and the location participants as part of the deployment phase of this project. Special thanks to Jack Broadbent and

Damian Breen from Bay Area AQMD and Randall Pasek, Adewale Oshinuga, and Richard Carlson at the South Coast AQMD

We would finally like to thank Don Pacocha, Edward O’Neil, and Joe Valdez of CE-CERT for their assistance in carrying out the experimental program. We would like to thank CE-CERT students and staff, Kurt Bumiller, Nick Gysel, and Joseph Menke for support in the project. We also thank UC Santa Cruz engineering student Jackson Burnette for assistance during activity data collection.

## Table of Contents

<b>Disclaimer .....</b>	<b>ii</b>
<b>Acknowledgments .....</b>	<b>ii</b>
<b>Table of Contents .....</b>	<b>iv</b>
<b>List of Tables .....</b>	<b>vii</b>
<b>List of Figures.....</b>	<b>viii</b>
<b>Abstract.....</b>	<b>xi</b>
<b>Acronyms and Abbreviations .....</b>	<b>xii</b>
<b>Executive Summary .....</b>	<b>xiii</b>
<b>1 Introduction .....</b>	<b>1</b>
<b>2 Deployment.....</b>	<b>2</b>
2.1 Deployment cost comparison .....	2
2.2 Fund distributions.....	2
2.3 Customer feedback.....	3
<b>3 Experimental.....</b>	<b>5</b>
3.1 Hybrid construction equipment description .....	5
3.2 Activity Data Collection.....	7
3.3 Emissions Measurements .....	10
3.3.1 PEMS Description.....	10
3.3.2 Data Collected.....	11
3.3.3 Test Units.....	12
3.3.4 Engine/Equipment Inspection.....	14
3.3.5 State of Charge Determination.....	14
3.3.6 Test Fuel.....	14
3.3.7 Quality Control.....	15
3.3.8 Data Processing .....	16
<b>4 Activity Results .....</b>	<b>17</b>
4.1 Caterpillar.....	17
4.1.1 Interview data.....	17
4.1.2 Development of event data .....	18
4.1.3 ECM and GPS .....	21
4.1.4 Characterization of time fractions spent in different modes .....	24
4.1.5 Statistics uni-modal analysis .....	26
4.1.6 Statistics bi-modal analysis .....	30
4.1.7 Contour plots.....	31
4.1.8 Bulldozer results summary .....	32
4.2 Komatsu excavators .....	34
4.2.1 Interview data.....	34
4.2.2 Development of Event Data.....	37
4.2.3 Video mode determination.....	38
4.2.4 ECM and GPS .....	41
4.2.5 Mode reduction.....	43
4.2.6 Hybrid versus conventional.....	45
4.2.7 Other sources of information .....	45
4.2.8 Statistics uni-modal analysis .....	46
4.2.9 Result summary .....	54

<b>5</b>	<b>Duty-cycle development .....</b>	<b>55</b>
5.1	Caterpillar bulldozer.....	55
5.1.1	<i>Caterpillar bulldozer published duty cycle .....</i>	<i>56</i>
5.1.2	<i>Third-party bulldozer evaluations.....</i>	<i>56</i>
5.1.3	<i>UCR analysis.....</i>	<i>56</i>
5.1.4	<i>Proposed duty cycle.....</i>	<i>56</i>
5.1.5	<i>Evaluation of proposed duty cycle .....</i>	<i>58</i>
5.1.6	<i>Revised duty cycle .....</i>	<i>72</i>
5.1.7	<i>Cycle weighting function.....</i>	<i>77</i>
5.2	Komatsu excavator.....	79
5.2.1	<i>Komatsu excavator duty cycle.....</i>	<i>80</i>
5.2.1	<i>UCR Analysis .....</i>	<i>81</i>
5.2.2	<i>UCR Proposed duty cycle.....</i>	<i>81</i>
5.2.3	<i>Evaluation of proposed duty cycle .....</i>	<i>84</i>
5.2.4	<i>Cycle weighting function.....</i>	<i>84</i>
<b>6</b>	<b>Emission Results .....</b>	<b>89</b>
6.1	Caterpillar bulldozers .....	89
6.1.1	<i>Analysis .....</i>	<i>90</i>
6.1.2	<i>D7E-T4i vs D6T-T4i Results .....</i>	<i>90</i>
6.1.3	<i>D7E-T4i vs D8T-T4i Results .....</i>	<i>102</i>
6.1.4	<i>D7E-T4i vs D8R-T2 Results .....</i>	<i>107</i>
6.1.5	<i>Idle analysis.....</i>	<i>111</i>
6.1.6	<i>Operator differences.....</i>	<i>111</i>
6.1.7	<i>Regenerations.....</i>	<i>111</i>
6.1.8	<i>Facility differences .....</i>	<i>112</i>
6.1.9	<i>Overall benefit.....</i>	<i>112</i>
6.2	Komatsu excavators .....	116
6.2.1	<i>Test excavators and operators .....</i>	<i>116</i>
6.2.2	<i>Test locations and dug materials.....</i>	<i>117</i>
6.2.3	<i>How testing was conducted.....</i>	<i>117</i>
6.2.4	<i>Analysis .....</i>	<i>119</i>
6.2.5	<i>Controlled in-service results .....</i>	<i>119</i>
6.2.6	<i>Operator differences.....</i>	<i>126</i>
6.2.7	<i>Average Modal differences: HB215 vs PC200 vs PC220 .....</i>	<i>128</i>
6.2.8	<i>Facility differences (soil compaction and density).....</i>	<i>131</i>
6.2.9	<i>Overall benefit.....</i>	<i>132</i>
<b>7</b>	<b>Summary and Conclusions .....</b>	<b>135</b>
7.1	Deployment .....	135
7.2	Activity measurements.....	135
7.3	Duty cycle development.....	136
7.4	Emissions of off-road hybrids .....	136
<b>8</b>	<b>Recommendations.....</b>	<b>140</b>
8.1	Deployment .....	140
8.2	Activity characterization .....	140
8.3	Duty cycle .....	140

8.4 Emissions .....	141
<b>References .....</b>	<b>143</b>
<b>Appendix A.</b> Activity Support Analysis Bulldozer.....	A-1
<b>Appendix B.</b> Activity Data Filtering Bulldozer .....	B-1
<b>Appendix E.</b> PEMS Testing SOPs and Updates .....	E-1
<b>Appendix F.</b> Equipment and Earth Bulk Materials .....	F-1
<b>Appendix G.</b> Caterpillar Bulldozer Specifics.....	G-1
<b>Appendix H.</b> Equipment Inspection Report .....	H-1
<b>Appendix I.</b> Supplementary Emissions Bulldozer.....	I-1
<b>Appendix J.</b> Supplementary Emissions Excavator .....	J-1
<b>Appendix K.</b> Engine Lug curves.....	K-1
<b>Appendix L.</b> Overall Summary of Program .....	L-1

## List of Tables

Table 2-1 Equipment deployment participants and monetary distribution summary.....	3
Table 2-2 Overall summary of deployment vouchers and equipment purchase price.....	3
Table 2-3 Feedback from testing customers and purchase plans.....	4
Table 3-1 Real time data logging GSP and ECM data recorded .....	10
Table 3-2 Hybrid and conventional bulldozer available for this evaluation.....	13
Table 3-3 Available Komatsu excavators comparable to the hybrid HB215LC-1 .....	14
Table 4-1 Mode identification for all documented modes for WM, RC, and OC .....	21
Table 4-2 Data records collected for each participant for the D7E and D8R.....	21
Table 4-3 Event records collected for each participant for the D7E and D8R .....	22
Table 4-4 Idle time as measured during activity assessment for each of the participants <sup>1</sup> .....	22
Table 4-5 Video and ECM activity mode percent time fractions for the D7E and D8R.....	26
Table 4-6 Distance event summary statistics weighted by operational mode .....	33
Table 4-7 Power event summary statistics weighted by operational mode .....	33
Table 4-8 Mode identification for excavators.....	38
Table 4-9 Video and ECM activity mode percent time fractions for the HB215 and PC200 .....	40
Table 4-10 Summary of total ECM and video collected from each participant .....	41
Table 4-11 Date record collected from each participant for HB215 and PC200.....	42
Table 4-12 Excavator idle time measured during activity assessment .....	42
Table 5-1 Summary of the D6T performance data pulling a loaded container .....	68
Table 5-2 Excavator test cycle sequence .....	82
Table 5-3 Calculation of observed weighting mode fractions .....	85
Table 5-4 Assumptions and calculation of state-wide mode fractions .....	86
Table 5-5 Excavators Competing with the HB215 .....	87
Table 6-1 Hybrid and conventional bulldozers tested as part of this evaluation .....	90
Table 6-2 Equipment emission certification results.....	101
Table 6-3 Equipment emission certification standard .....	102
Table 6-4 PM, CO, and THC brake specific emissions for the controlled pull testing .....	102
Table 6-5 Hybrid weighted comparison to the D6T conventional .....	112
Table 6-6 Hybrid weighted comparison to the D8T conventional .....	113
Table 6-7 Hybrid weighted comparison to the D8R and other conventionals.....	114
Table 6-8 PM, CO, and THC brake specific emissions for the in-use tests. ....	115
Table 6-9 Test Excavator Descriptions.....	116
Table 6-10 Order of test modes with methods and notes.....	118
Table 6-11 Range of overall benefits of HB215 relative to conventional .....	132
Table 6-12 State-average benefits/dis-benefits of using the HB215 instead of the PC 200 .....	134

## List of Figures

Figure 3-1 Schematic of Caterpillar D7E's Drivetrain Layout (Source: Caterpillar Inc.).....	5
Figure 3-2 Schematics of hybrid System on Komatsu (source: Komatsu USA).....	6
Figure 3-3 Physical representation of the Komatsu hybrid excavator (source: Komatsu USA) .....	7
Figure 3-4 Activity measurement tools ECM, GPS, and time lapse video on the D7E .....	8
Figure 3-5 Activity measurement tools, ECM, GPS, and time lapse video on the HB215. ....	9
Figure 4-1 GPS overlay onto Google Maps to show physical in-service activity .....	19
Figure 4-2 Same as above except zooming in to time ~24000 to ~26000 data points .....	19
Figure 4-3 Bulldozer GPS and ECM event results for typical pushes and pulls .....	20
Figure 4-4 Bulldozer event identification using heading change .....	20
Figure 4-5 Typical engine power, % load, rpm and catalyst exit temperature for a D7E .....	23
Figure 4-6 Typical unit speed, fuel rate, and rpm for a D7E .....	23
Figure 4-7 Typical engine power, % load, and rpm for a D8R .....	24
Figure 4-8 Typical unit speed, fuel rate, and rpm for a D8R.....	24
Figure 4-9 Activity time lapse video from the bulldozer for various operations.....	25
Figure 4-10 Video fractions and ECM fractions by mode for each participant.....	25
Figure 4-11 Histogram plots for the D7E at WM (a), RC (b), OC (c) and the D8R WM (d) .....	28
Figure 4-12 50 <sup>th</sup> percentile statistics for valid events by mode for the D7E and D8R <sup>1</sup> .....	29
Figure 4-13 Bi-modal mean histogram for power at WM all modes combined.....	30
Figure 4-14 Bi-modal mean histogram for fuel consumption at WM all modes combined .....	31
Figure 4-15 Bi-modal mean histogram for unit speed (km/hr) at WM all modes combined .....	31
Figure 4-16 Contour plots for distance, power, and frequency for all bulldozers .....	32
Figure 4-17 Power event comparison for largest operational mode .....	34
Figure 4-18 Distance event comparison for largest operational mode .....	34
Figure 4-19 Main parts of an excavator .....	35
Figure 4-20 Excavator with "thumb" and "quick coupler" attachments .....	36
Figure 4-21 Excavator video modal data plot (17 Dec 2012).....	39
Figure 4-22 Typical hybrid excavator engine loads at Ft. Hunter Liggett.....	43
Figure 4-23 Diamond D hybrid compacting second by second ECM data distribution.....	43
Figure 4-24 Activity time lapse video from the excavator for various operations .....	45
Figure 4-25 Bucket capacity definitions from the (Caterpillar Performance Handbook) .....	46
Figure 4-26 Influence of materials on bucket payload .....	46
Figure 4-27 Engine power for carry, grab, and dress modes .....	47
Figure 4-28 Engine speed for carry, grab, and dress modes .....	47
Figure 4-29 Engine power for s-trench and b-backfill modes .....	48
Figure 4-30 Engine speed for s-trench and b-backfill modes .....	48
Figure 4-31 Engine power for crane and maneuver modes .....	49
Figure 4-32 Engine speed for crane and maneuver modes .....	49
Figure 4-33 Engine power for compact and s-backfill modes.....	50
Figure 4-34 Engine speed for compact and s-backfill modes.....	50
Figure 4-35 Engine power for move/travel, b-trench, and b-scoop modes .....	51
Figure 4-36 Engine speed for move/travel, b-trench, and b-scoop modes .....	51
Figure 4-37 Engine speed, power, and % load for the hybrid excavator at DD, mode travel. ....	52
Figure 4-38 Engine speed, power, and % load for the conventional excavator at DD, mode travel. .	52
Figure 4-39 Engine fuel rate, power, speed, and percent load summary statistics .....	53
Figure 5-1 Delivery of one load of three inch minus rock (~13 tons) .....	59



Figure 5-2 Delivery of eight loads of three inch minus rock (104 tons).....	59
Figure 5-3 D6T bulldozer pushing a single 13 ton full load pile 30 meters .....	61
Figure 5-4 D6T Controlled pushing 30 meters for portions of the eight 13 ton piles .....	62
Figure 5-5 D6T 30 meter push after the 4th pass of the bulldozer .....	62
Figure 5-6 D6T Rock Pile pushes showing windrow formation. ....	63
Figure 5-7 Massive windrows (~3 ft high) after a few full blade pushes. ....	63
Figure 5-8 Blade spillage or “windrows” during OC bulldozing .....	64
Figure 5-9 Material changed from 0 hours “A” to 2 hour “B” of bulldozer pushing .....	64
Figure 5-10 Example of method to prevent windrows .....	65
Figure 5-11 Pushing large heavy objects as an alternative to pushing piles (7.5 and 3.5 ton rocks) .	66
Figure 5-12 Typical tractor pull approach for evaluating tractor performance .....	67
Figure 5-13 Pull test approach with D6T and container loaded with 13 tons of rock .....	67
Figure 5-14 Pull test approach showing 3 loads of 3” minus rock in container (#3 bin D8T) .....	68
Figure 5-15 D7E drawbar pull from caterpillar published material .....	69
Figure 5-16 Typical unit speed, fuel rate, and rpm for a D7E in-service at WM.....	70
Figure 5-17 Typical unit speed, fuel rate, and rpm for a D8R in-service at WM.....	70
Figure 5-18 D6T Controlled 30 meter pulling of a fixed loaded container .....	71
Figure 5-19 D6T Controlled 30 meter forward and backwards with no container.....	71
Figure 5-20 In-service dirt and 6in minus rock pile pushing – D6T. ....	74
Figure 5-21 WM’s D7E in-service trash push at El Sobrante landfill near Corona, CA.....	75
Figure 5-22 WM’s D8R in-service trash push at El Sobrante landfill near Corona, CA .....	75
Figure 5-23 OC’s D7E performing slope cleaning in-service push river maintenance. ....	76
Figure 5-24 OC’s D7E performing 50’x50’ pad cut in-service test. ....	76
Figure 5-25 Percent fraction of selected bulldozers in CA, source DOORs YR2013 .....	78
Figure 5-26 Age distribution of all bulldozers in CA, source DOORs YR2013 .....	78
Figure 5-27 Komatsu cycle used to evaluate between excavator technology improvements.....	80
Figure 5-28 Sketch of excavator test cycle .....	83
Figure 5-29 Observed construction and demolition mode fractions.....	85
Figure 5-30 Estimated state-wide mode fractions .....	86
Figure 5-31 Percentage of Excavators in the 150 to 200 hp range (source DOORS YR2010).....	88
Figure 6-1 CO <sub>2</sub> Emissions on a g/hr and g/ton basis for the different controlled push tests D6T.....	91
Figure 6-2 NO <sub>x</sub> Emissions on a g/hr and g/ton basis for the different controlled push tests.....	92
Figure 6-3 PM Emissions on a g/hr and g/ton basis for the different controlled push tests. ....	93
Figure 6-4 CO Emissions on a g/hr and g/ton basis for the different controlled push tests. ....	94
Figure 6-5 THC Emissions on a g/hr and g/ton basis for the different controlled push tests.....	95
Figure 6-6 Controlled in-use testing performance ton/hr D7E vs D6T. ....	97
Figure 6-7 Controlled in-use testing CO <sub>2</sub> emissions g/ton D7E vs D6T. ....	98
Figure 6-8 Controlled in-use testing NO <sub>x</sub> emissions g/ton D7E vs D6T.....	98
Figure 6-9 CO <sub>2</sub> emissions on a brake specific basis for the different controlled push tests.....	99
Figure 6-10 NO <sub>x</sub> emissions on a brake specific basis for the different controlled push tests, WM. ....	100
Figure 6-11 NO <sub>x</sub> emissions on a brake specific basis for the different controlled in-use tests, OC. ....	100
Figure 6-12 Engine load as a function of engine speed for the D6T and D7E .....	101
Figure 6-13 CO <sub>2</sub> Emissions on a g/hr and g/ton basis for the controlled pull tests D8T.....	103
Figure 6-14 NO <sub>x</sub> Emissions on a g/hr and g/ton basis for the controlled pull tests D8T.....	104
Figure 6-15 CO <sub>2</sub> emissions on a g/hp-hr basis for the D8T.....	106
Figure 6-16 NO <sub>x</sub> emissions on a g/hp-hr basis for the D8T. ....	107
Figure 6-17 Engine load as a function of engine speed for the D8T .....	107
Figure 6-18 CO <sub>2</sub> emissions for the D8R vs D7E during in-revenue service testing.....	108
Figure 6-19 NO <sub>x</sub> emissions for the D8R vs D7E during in-revenue service testing .....	109

Figure 6-20 NO <sub>x</sub> correlation to power for selected testing points D7E-T4i and D8R-T2.....	109
Figure 6-21 PM emissions for the D8R vs D7E during in-revenue service testing.....	110
Figure 6-22 THC correlation to power for selected testing points D7E-T4i and D8R-T2.....	110
Figure 6-23 Engine load as a function of engine speed for the D8R.....	111
Figure 6-24 D7E versus D6T comparison over controlled pull testing.....	113
Figure 6-25 D7E versus D8T over controlled pull testing.....	114
Figure 6-26 Measurement of trench dimensions .....	119
Figure 6-27 PC200 CO <sub>2</sub> modal test results .....	120
Figure 6-28 Average travel speeds of excavators .....	121
Figure 6-29 PC200 NO <sub>x</sub> modal test results .....	122
Figure 6-30 PC200 PM modal test results .....	122
Figure 6-31 HB215 CO <sub>2</sub> modal test results.....	123
Figure 6-32 HB215 NO <sub>x</sub> modal test results .....	124
Figure 6-33 HB215 PM modal test results .....	124
Figure 6-34 PC220 CO <sub>2</sub> modal test results .....	125
Figure 6-35 PC220 NO <sub>x</sub> modal test results .....	125
Figure 6-36 PC220 PM modal test results .....	126
Figure 6-37 Operator Influence on Emissions per Job .....	127
Figure 6-38 Productivity of different operators and excavator models .....	128
Figure 6-39 Average modal CO <sub>2</sub> (fuel consumption) differences between excavator models .....	129
Figure 6-40 Average modal NO <sub>x</sub> differences between excavator models .....	130
Figure 6-41 Average modal PM differences between excavator models .....	130
Figure 6-42 Engine load as a function of engine speed for the HB215LC-1 and PC200.....	131
Figure 6-43 Model-average CO <sub>2</sub> rate for construction, demolition, and statewide .....	133
Figure 6-44 Model-average NO <sub>x</sub> rate for construction, demolition, and statewide .....	133
Figure 6-45 Model-average PM rate for construction, demolition, and statewide .....	134

## **Abstract**

The goal of the Hybrid Off-Road Equipment Pilot Project is to accelerate deployment of commercialized hybrid construction equipment while evaluating the emissions benefits of the equipment in real world applications. The main focus of this first of its kind research is to evaluate the emissions impact of commercially-available hybrid construction equipment under real in-use operation relative to its non-hybrid counterparts

UCR was awarded a grant to deploy, characterize, quantify, and evaluate the benefits of two commercially available hybrid off-road construction units, the Caterpillar D7E and the Komatsu HB215LC-1 (HB215). Six participants/end users were selected to have emissions from their deployed project equipment evaluated as part of this hybrid off-road project. The program facilitated the deployment of 16 hybrid construction units with eight fleets operating in approximately eight locations. The hybrid construction equipment included ten Caterpillar D7E bulldozers and six Komatsu HB215LC-1 excavators.

In order to characterize the typical operation of different units, activity measurements were made on a subset of 6 hybrid and 4 comparable conventional construction equipment, activity data were obtained using interviews, historical records, and in-use activity measurements that include time-lapse video, real-time engine control module (ECM) broadcast data, and real-time GPS data. The activity measurements were used to develop duty cycles that were representative and also repeatable in terms of getting good comparisons between the different equipment.

A subset of 12 pieces of hybrid and conventional equipment were then evaluated for emissions and fuel consumption over the developed duty cycles and in revenue service using a 1065 approved particulate matter (PM) and gaseous portable emissions measurement system (PEMS). The measurements were made from six different in-service fleets three for the bulldozer and three for the excavator. Each fleet represented a unique operation to investigate a broad range of equipment usage.

Both the hybrid bulldozers and excavators showed an overall fuel consumption reduction benefit compared to an equivalent conventional, but a dis-benefit (i.e., increase) for some pollutants. The results of this study are analyzed and summarized in the following report.

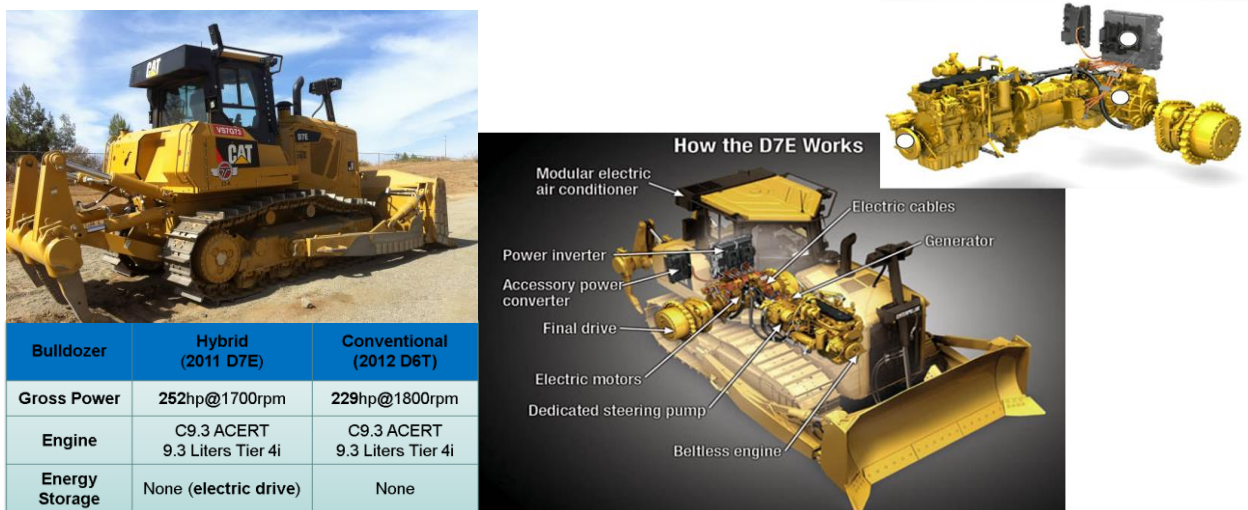
## Acronyms and Abbreviations

40 CFR 1065 or 1065	Part 1065 of Title 40 of the Code of Federal Regulations
ARB	Air Resources Board
bs	brake specific
ARB	California Air Resources Board
CE-CERT	College of Engineering-Center for Environmental Research and Technology (University of California, Riverside)
CFO	critical flow orifice
CFR	Code of Federal Regulations
CO	carbon monoxide
COV	coefficient of variation
CO <sub>2</sub>	carbon dioxide
CVS	constant volume sampling
DOC	diesel oxidation catalyst
DPF	diesel particulate filter
DR	dilution ratio
ECM	engine control module
efuel	ECM fuel consumption rate
EPA	United States Environmental Protection Agency
FID	flame ionization detector
GFM	gravimetric filter module
g/hp-h	grams per brake horsepower hour
lpm	liters per minute
MDL	minimum detection limit
MEL	CE-CERT's Mobile Emissions Laboratory
MFC	mass flow controller
NMHC	non-methane hydrocarbons
NTE	Not-to-exceed
NO <sub>x</sub>	nitrogen oxides
OC	organic carbon
OEM	original equipment manufacturer
PEMS	portable emissions measurement systems
PM	particulate matter
RPM	revolutions per minute
scfm	standard cubic feet per minute
Tier 2, 3, or 4	federal emissions standards levels for off-road diesel engines
THC	total hydrocarbons
UCR	University of California at Riverside
ULSD	ultralow sulfur diesel

## Executive Summary

The goal of the Hybrid Off-Road Equipment Pilot Project is to accelerate deployment of commercialized hybrid construction equipment while evaluating the emissions benefits of the equipment in real world applications. The focus of this first of its kind research is to evaluate the emissions impact of existing hybrid technology when used during typical in-use operation. As part of this project, the University of California, Riverside College of Engineering – Center for Environmental Research and Technology (CE-CERT) facilitated the deployment of ten hybrid Caterpillar D7E bulldozers and six hybrid Komatsu HB215LC-1 excavators with eight California-based fleets. Hundreds of hours of in-use D7E dozer and HB215LC-1 excavator activity were observed and logged at six locations to develop typical in-use hybrid dozer and excavator duty cycles. Since exact non-hybrid versions of the hybrid D7E dozer and HB215LC-1 excavator do not exist, emission comparisons were made relative to the most similar non-hybrid dozer and excavator models. Figures ES-1 and ES-2 describe how the hybrid D7E dozer and HB215LC-1 excavator function and identify the most similar non-hybrid equipment chosen for emission comparisons.

This Executive Summary briefly summarizes project activity measurement and duty cycle development, and provides emission testing results for project hybrid equipment relative to its most similar non-hybrid counterparts – the Caterpillar D6T dozer and the Komatsu PC200 excavator. These comparisons provide the closest approximation of the emissions impact of hybridizing the Caterpillar D7E and the Komatsu HB215LC-1. Additional details regarding project activity measurement and duty cycle development, as well as emission comparisons with other conventional dozer and excavator models, can be found in the main report.



**Figure ES-1: Hybrid D7E Caterpillar bulldozer evaluated (source Caterpillar Inc.)**

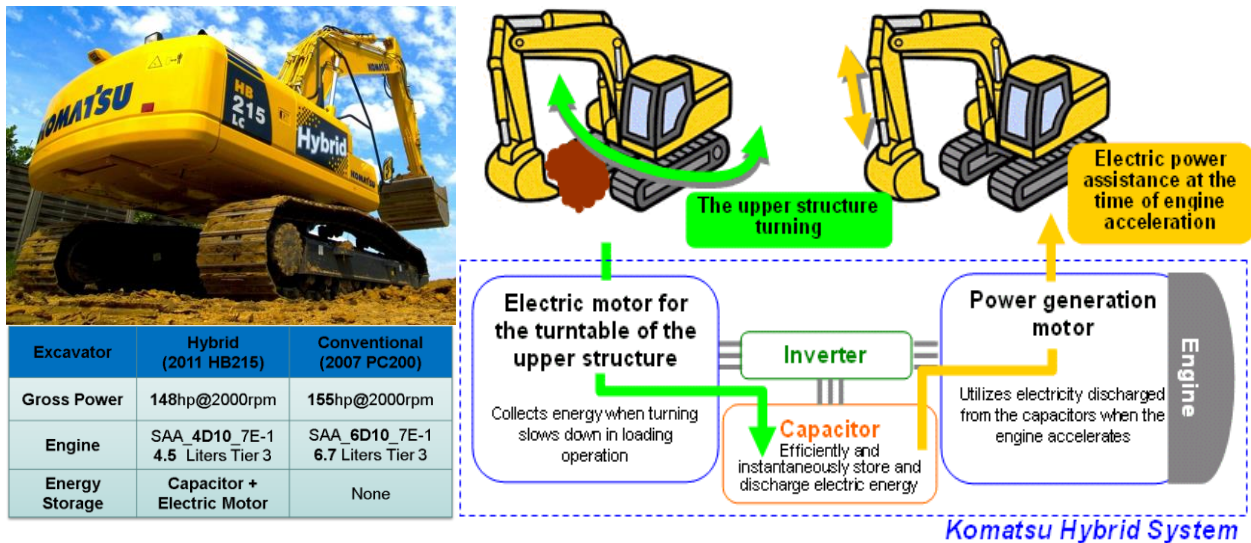


Figure ES-2: Hybrid HB-215-LC-1 Komatsu excavator evaluated (source Komatsu)

### Activity measurement

The first phase of this project involved determining the activity (i.e. the types of physical work performed), the loads on the engines, and how much time is spent in each mode. This required a first of its kind comprehensive effort to install time lapse cameras, global positioning systems (GPS), and engine control module (ECM) loggers to fully characterize what work is being performed (see Figure ES-3 for typical installation).



Figure ES-3: Activity measurement setup on the Caterpillar D7E hybrid

Activity measurement highlights include:

- CE-CERT assessed activity by using interviews, historical records, time-lapse video, ECM broadcast data, and real time GPS.
- Activity measurements were made on a subset of six hybrid and various comparable pieces of conventional equipment.

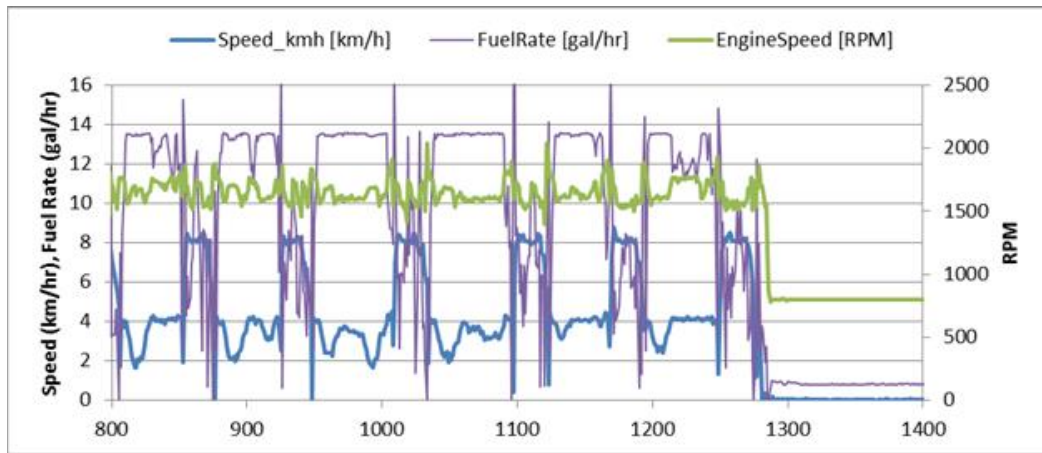
- Activity includes both physical work (P-work) and engine work (E-work).
  - P-work represents what is being pushed, lifted, dug, etc. and how.
  - E-work captures engine response to the load imposed by the physical work.
  - P-work dictates the load on the engine, engine speed, and how fast the unit moves.
  - Video data was critical for determining P-work.
- ECM data recorded during known activity from the video was critical in developing the duty cycles for emissions testing.
- ECM fuel flow data was evaluated and found to be relatively accurate. ECM fuel consumption data for the hybrid bulldozer compared within 5 percent to Waste Management’s fuel records.

*Bulldozer*

- Over 160 hours of E-work and over 2000 hours of P-work data was collected for the bulldozers.
- For the bulldozer, P-work ranged from refuse pushing, road building, rock pushing, river bed clearing, to slope repairs. See Figure ES-4 for examples of time lapse pictures, as well as the main report for more details.
- For the bulldozer the video and GPS data were used to determine activity.
- Bulldozer activity consists of forward pushing and backward movement to prepare for next push. See Figure ES-5 for an example of the real time engine data and the report for more details.
- Statistical analysis of over 130,000 events was used as the basis of the proposed duty cycles for the bulldozers.



**Figure ES-4: Time lapse video photographs for various operations for the hybrid D7E bulldozer**



**Figure ES-5: Example of real time engine activity logging for the hybrid D7E bulldozer**

*Excavator*

- Over 160 hours of E-work and over 2000 hours of P-work was collected for the excavators.
- Excavator P-work varied significantly and represented over 15 different modes ranging from trenching, dressing (short rotations of excavator turn table to prepare a surface), lifting, holding, hammering, and demolishing. In each mode there were large and small buckets and long and short reaches, and short and long swings. See Figure ES-5 for typical project time lapse data (More detail is provided in the main report).
- For the excavator, activity was determined from video mode data rather than GPS monitoring, since excavator work consists of more stationary operations in which just the vehicle and/or swing arm rotates.
- Statistical analysis of the synchronized video mode data with ECM data reduced P-work work modes from 15 to seven work modes by combining work modes having similar ECM data. These seven work modes adequately characterized in-use excavator emissions.



**Figure ES-6: Time lapse video photographs for various operations for the hybrid HB-215LC excavator**



### Activity results and duty cycle development

The activity logging effort led to the development of real world duty cycles, which are the cornerstone to determining the overall emissions benefit of off-road equipment hybridization. Representative and repeatable comparisons between hybrid and baseline equipment require having the equipment perform the same task under conditions as similar as physically possible. To relate in-use service conditions to controlled test conditions required a statistical analysis of the measured activity data. The duty cycles developed for the bulldozer and excavator are summarized below:

- Activity statistics show that the bulldozer push distance and power varies by operational mode and by fleet facility.
- Based upon the overall bulldozer statistical analysis, 10 meter, 30 meter, and 80 meter push distances at light and heavy loads were selected for the tests cycles. Table ES-1 shows the repeatability of the bulldozer test cycle. Repeatability was close to that of laboratory testing and showed low variability (i.e. less than 2% for engine load and around 5% for representative emissions).

Table ES-1: Repeatability of a bulldozer performance and emissions during cycle testing

	Power bhp	Torque ft-lb	Fuel kg/hr	Vel GPS km/h	Time Specific Emissions (g/hr)			
					CO2	NOx	THC	mg PM 3
	196.8	516.5	36.5	3.7	115450	202	2.5	43.8
	197.3	521.5	35.4	4.0	112089	197	2.5	41.5
	198.2	518.6	38.2	3.6	120765	199	2.0	45.1
	197.0	516.4	35.9	3.7	113479	211	2.3	41.8
	204.8	536.0	37.4	3.8	118201	212	1.8	43.8
	195.0	510.2	35.9	3.8	113654	202	2.0	39.3
	203.4	533.3	36.9	3.5	116617	206	2.1	44.1
ave	198.9	521.8	36.6	3.7	115751	204.2	2.2	42.8
std	3.7	9.4	1.0	0.2	3026	6.0	0.3	2.0
cov	1.8%	1.8%	2.6%	4.8%	2.6%	2.9%	12.3%	4.7%

<sup>1</sup> The average “ave” and single standard deviation “std” are based on seven measurements. Variability is described by the term “cov” which is the coefficient of variation as defined by a single standard deviation divided by the average.

- Based upon recorded excavator activity data, UCR developed a representative test cycle that drew heavily upon one previously proposed by Komatsu to evaluate the emissions and fuel economy of Komatsu hybrid and conventional excavators.
- Specific events evaluated over the representative cycle were: travel, idle, dress, trench with 45° swings, backfill, ditch with 90° swings, and dig with 180° swings. These modes represent both general construction and demolition type activity as recorded. Excavator swings are identified by the rotation of the upper structure with the base unit remaining in one position (i.e. not traveling).
- Two specific excavator vocations were identified, 1) general construction and 2) demolition. General construction includes shorter swings (trench 45 degrees) with some travel operation, and demolition includes dressing mode operation, longer rotations (180 degrees), and some travel.

### Emissions of off-road hybrids

The emissions and fuel consumption for the hybrid equipment were measured in-use during real world operation with AVL’s federally compliant M.O.V.E portable emission measurement systems

(PEMS). The AVL's M.O.V.E PEMS system includes measurements for carbon monoxide (CO), carbon dioxide (CO<sub>2</sub>), oxides of nitrogen (NO and NO<sub>2</sub>), total hydrocarbons (THC) and particulate matter (PM). Fuel consumption is measured using the carbon balance method similar to how vehicle fuel economy measurements are made. The PEMS system was installed on each of the units tested as shown in Figure ES-7 while performing the duty cycles developed as part of this project. The emissions findings are summarized below:

- Emission measurements were successfully performed for both the hybrid and conventional bulldozer and excavator while performing the typical in-use duty cycles developed for this project.
- The emissions and fuel consumption performance evaluations were primarily based on the mass of emissions per ton of earth moved.
- Idle, travel, and non-earth moving activities were factored into the overall emissions comparison on a grams per hour basis with a weighting function derived in this project.
- Emissions on a per brake horse power hour, per fuel use, and per yard basis were also performed (More detail is provided in the main report). Brake horse power was determined from ECM data and published lug curves for each engine.
- The final emissions and fuel consumption performance benefit for the hybrid D7E Tier 4 interim bulldozer are based on a comparison to the D6T Tier 4 interim conventional bulldozer.
- The final emissions and fuel consumption performance benefit for the hybrid HB215LC-1 Tier 3 excavator are based on a comparison to the PC200 Tier 3 conventional excavator.
- CO<sub>2</sub> emissions are directly related to fuel usage. Thus, a reduction in CO<sub>2</sub> emissions translates to a reduction in fuel consumption and improved fuel economy (FE).
- Hybrid emission and performance results are based on a comparison to the hybrid unit. Thus, negative numbers indicate a hybrid benefit (i.e. hybrid results are less than the conventional results) and positive number indicate a hybrid dis-benefit.

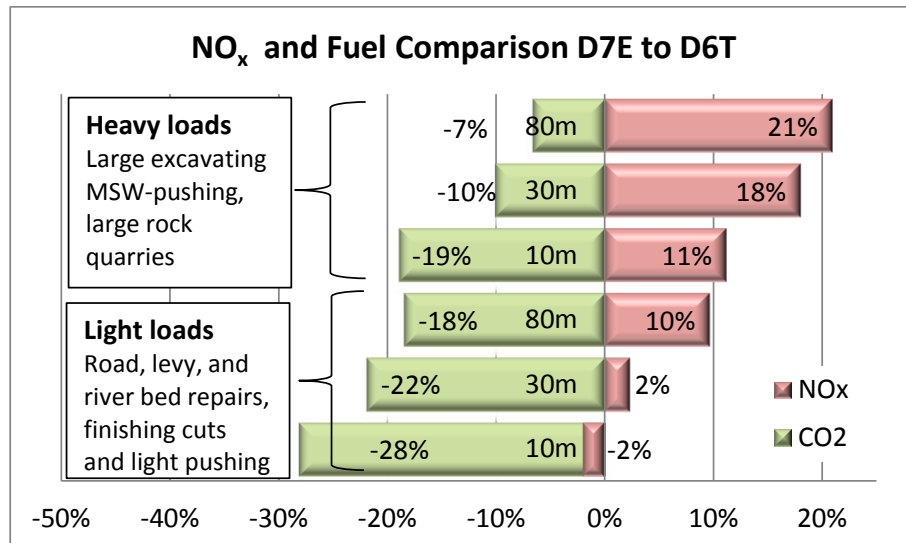


**Figure ES-7: PEMS in-use measurement example for the bulldozer and excavator units**

#### *Caterpillar hybrid D7E emission testing*

- Two hybrid D7E bulldozers and one conventional D6T bulldozer were evaluated during both controlled pull and in-service testing at two different locations. As mentioned earlier, the D6T is the conventional bulldozer model most similar in power, size and other key parameters to the hybrid D7E. Figure ES-8 shows the average emission comparisons to the D6T conventional bulldozer for different types of work performed. Emission comparisons between the hybrid D7E and other (less similar) conventional bulldozers are presented in the main report.

- The CO<sub>2</sub> emissions benefit ranged from a 28% benefit to a 2% dis-benefit and depended on push distance and push effort (See Figure ES-8).
- Fuel consumption is based on CO<sub>2</sub> emissions and thus its fuel savings also ranged from a 28% benefit to 2% dis-benefit and depended on push distance and push effort. In general, lighter, shorter pushes resulted in greater fuel economy benefit and heavier, longer pushes resulted in less fuel economy benefit. Typically heavy pushes are found in large excavation, landfills, and rock quarry operations, and lighter pushes are found in slope repairs, maintenance, fine trim type work, and road repair work.
- The hybrid bulldozer had an overall NO<sub>x</sub> emissions dis-benefit of 7% to 21%, depending upon work performed (See Figure ES-8).
- No benefit or dis-benefit could be quantified for PM, CO, and THC due to the low emission levels from the aftertreatment system (ATS) equipped engines on both the D7E and D6T units.



**Figure ES-8: Hybrid D7E NO<sub>x</sub> and FE benefit for typical dozer vocations**

<sup>1</sup> Negative values mean hybrid benefit and positive values mean dis-benefit

<sup>2</sup> PM, THC, and CO emission rates were very low for both the D7E and D6T and thus were not able to be quantified as a hybrid benefit or dis-benefit.

<sup>3</sup> Idle emissions showed a similar trend, with the hybrid emitting less CO<sub>2</sub> (-15%) and more NO<sub>x</sub> (+15%)

- Overall average weighted emission and fuel consumption impacts identified in Table ES-2 are based on a best estimate of typical activity for similar large, California-based dozers, based upon fleet surveys, dealer information, and ARB's Diesel Off-Road On-Line Registration System (DOORS) data base (See main report for details).
- Our weighted activity estimates resulted in the hybrid excavator having an overall CO<sub>2</sub> emissions and fuel consumption benefit of 14% and an overall NO<sub>x</sub> emissions dis-benefit of approximately 13%. (See main report for details).
- Brake specific and fuel specific analysis confirmed the NO<sub>x</sub> dis-benefit for the in-service testing, in-use testing, and controlled pull tests for all modes.
- The engine lug curves showed that the engine speed range of the D7E is very narrow relative to the D6T and this may be causing the higher in-use NO<sub>x</sub> emissions.

**Table ES-2: Hybrid D7E weighted emission comparison to the D6T conventional**

D7E Weighted Comparison to the D6T				
CO <sub>2</sub>	NO <sub>x</sub>	PM	THC	CO
-14%	<b>13%</b>	n/a	n/a	n/a

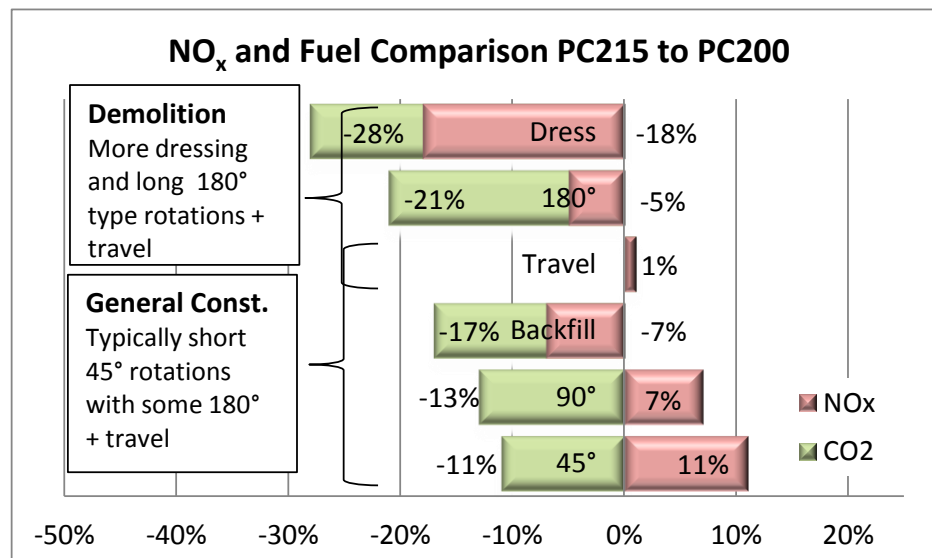
<sup>1</sup> Negative values mean hybrid benefit and positive values mean dis-benefit

<sup>2</sup> Calculated using best estimate of the typical operating mode

- Measured NO<sub>x</sub> levels were below engine emission certification standards. See the main report for actual values and difference relative to the emissions certification standards.

*Komatsu hybrid HP215LC-1 emission testing*

- Two PC200 excavators and three HB215LC-1 hybrid excavators were evaluated using the representative test cycle developed for this project. Figure ES-9 and ES-10 summarizes the hybrid weighted-average emissions comparisons to the typical conventional excavator. Results utilizing a different conventional excavator model (PC220) are presented in the main report.



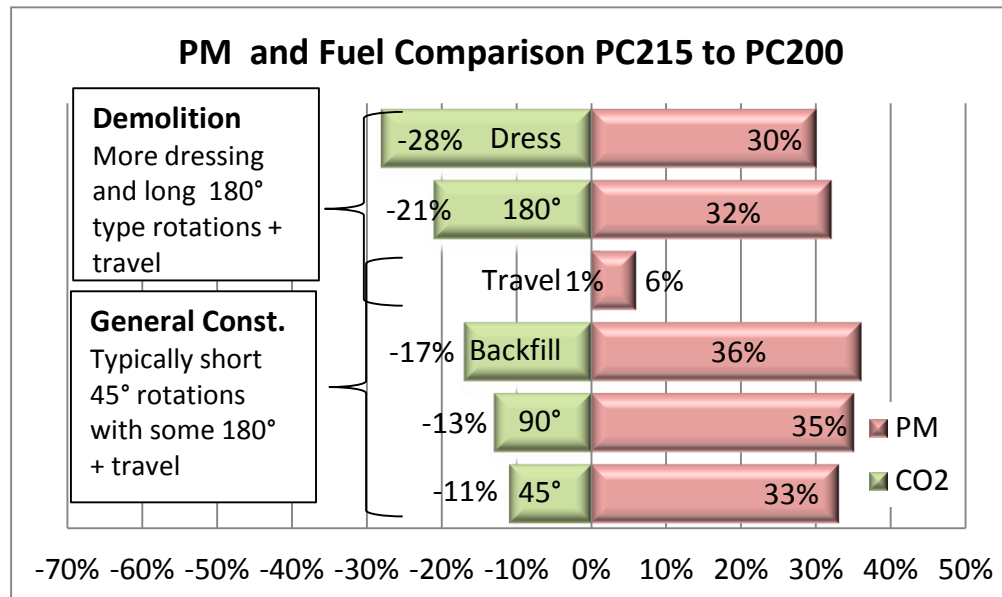
**Figure ES-9: Hybrid PC2015 NO<sub>x</sub> and FE benefit for typical excavator vocations**

<sup>1</sup> Negative values mean hybrid benefit and positive values mean dis-benefit

<sup>2</sup> CO was mixed and ranged from -5% to +21%. THC was lower and ranged from -48% to -73%, see report for details.

<sup>3</sup> The hybrid idle emissions showed a lower CO<sub>2</sub>, PM, CO and THC emissions of -43%, -85%, -66%, and -75% respectively and no difference in NO<sub>x</sub> emissions (0%).

- The CO<sub>2</sub> benefit of the hybrid varied from a 28% benefit to a 1% dis-benefit, where the highest benefit was for dressing mode (i.e. light surface work with short rotations of the upper structure). The dis-benefit was for the travel mode.
- Demolition type work averaged about a 23% benefit (demolition work typically uses longer swings of the arm, which captures/releases more energy). General construction consists of more trenching and backfilling which resulted in a lower average of about a 13% benefit.
- The hybrid NO<sub>x</sub> emissions impact varied from an 18% benefit for demolition work to an 11% dis-benefit for general construction work. (See Figure ES-9).



**Figure ES-10: Hybrid PC215 PM and F.E benefit for typical excavator vocations**

<sup>1</sup> Negative values mean hybrid benefit and positive values mean dis-benefit

<sup>2</sup> The hybrid idle emissions showed a lower PM at around -85%

- The hybrid PM dis-benefit was around 27% for all types of work and ranged from 6% for travel to 36% for backfill. (See main report for details).
- Table ES-3 provides the overall weighted emissions and fuel consumption estimates developed, based on activity data, fleet surveys, dealer information, and ARB's DOORS data base. Additional details are provided in the main report.
- Using the weighting estimates, the hybrid excavator had an overall fuel consumption, CO<sub>2</sub>, and THC emissions benefit of 16%, 16%, and 70% respectively and a NO<sub>x</sub>, PM and CO emissions dis-benefit of approximately 1%, 27%, and 8% respectively (See report for details).

**Table ES-3: Hybrid PC215 weighted emission comparison to the PC200 conventional**

HB215LC-1 Weighted Comparison to the PC200				
CO <sub>2</sub>	NO <sub>x</sub>	PM	THC	CO
-16%	1%	27%	-70%	8%

<sup>1</sup> Negative values mean hybrid benefit and positive values mean dis-benefit

<sup>2</sup> Calculated using best estimate of the typical operating mode

- During heavy work the engine speed variation for the hybrid was much larger compared to the conventional, which may be the reason for the PM and CO dis-benefits.

### Summary

The full report also contains a detailed list of lessons learned regarding activity measurements, data analysis, duty cycle development, and emissions testing. Additionally the final report identifies possible causes of higher emissions from the hybrid equipment and provides recommendations for reducing hybrid construction equipment emissions in next generation models.

# 1 Introduction

Hybrid off-road excavators and dozers are now available for purchase by California fleets. This technology has potential to provide significant criteria pollutant and greenhouse gas emission reductions, with commensurate fuel economy benefits and fuel cost savings. As of the time of this study, two manufacturers – Caterpillar and Komatsu – offered hybrid construction equipment for sale in California, and other manufacturers were preparing to offer hybrid equipment over the next few years. This technology offers an opportunity for lower emissions and fuel economy savings; however, little independent in-use emissions testing has been conducted to evaluate emission benefits of hybrid equipment relative to its non-hybrid counterparts.

Hybrid equipment manufacturers typically report 20% fuel economy benefits and 30% emissions reductions compared to similar conventional equipment. Several studies have shown that the true benefits for the mature on-highway, heavy-duty hybrid performance can vary significantly, and the actual benefits depend on the real-world application. The deployment of hybrids in construction equipment applications, which have a unique and diverse duty cycle, is in the very early stages. These systems also have not been independently evaluated during in-use operation. Thus, it is unknown what the true benefit of the hybrid equipment deployment is and where the focus of limited resources should be strategically allocated for this application. At this early stage of deployment, fuel consumption and emissions evaluations are warranted to assess the in-use benefit.

The goal of this study was to provide an extensive testing program to evaluate emissions and fuel consumption from hybrid construction equipment in comparison with more conventional construction equipment. As part of this program, CE-CERT facilitated the deployment of 16 hybrid construction units with eight fleets operating in approximately eight locations. The hybrid construction equipment included ten Caterpillar D7E bulldozers and six Komatsu HB215LC-1 excavators. In order to characterize the typical operation of different units, activity measurements were made on a subset of 6 hybrid and 4 comparable conventional construction equipment. Activity data were obtained using: interviews, historical records, and in-use activity measurements. In-use activity measurements included time-lapse video, real-time engine control module (ECM) broadcast data, and real-time GPS data. The activity measurements were used to develop duty cycles that were representative and also repeatable to allow fair and accurate comparisons between the different equipment. A subset of 12 pieces of hybrid and conventional equipment were then evaluated for emissions and fuel consumption over the developed duty cycles and in revenue service using a 40 CFR 1065 approved particulate matter (PM) and gaseous portable emissions measurement system (PEMS).

The measurements were made from six in-service fleets three for the bulldozer and three for the excavator. Each fleet represented a unique operation to investigate a broad range of equipment usage. The results of this study are analyzed and summarized in the following report.

## **2 Deployment**

This section describes the distribution of funds for the deployment of the hybrid units, the cost comparisons, the participating fleets, details on the deployed dollars, and customer feedback from the units and the grant process. Additionally, some fleets were sufficiently satisfied with the performance of the hybrid equipment, purchased through this program; they purchased additional units without financial assistance.

### **2.1 Deployment cost comparison**

The AQIP program provided a total of \$901,578 voucher dollars towards the purchase of either hybrid and \$905,308 for the emissions and fuel economy testing of at least 6 bulldozers and 6 excavators, 3 hybrid and 3 conventional of each. The testing dollars include \$183,500 paid to the participants to offset disruptions in their normal operations while the testing was being conducted.

Between September 21, 2011 and December 6, 2012 16 requests for vouchers were received, ten for the purchase of the Cat D7E bulldozer and six for the purchase of the Komatsu HB215LC-1 excavator. The voucher requests are from 7 agencies, 5 private and 2 public. The AQIP program provided funds to offset about half the difference between the purchase price of the hybrid equipment versus the conventional equipment. Based upon information supplied by Caterpillar and Komatsu dealerships, and team members who had price quotes for hybrid and conventional equipment before the AQIP program was initiated, it was determined that the hybrid bulldozer costs about \$150,000 more than a comparable conventional bulldozer and the hybrid excavator costs about \$57,000 more than the conventional excavator. Therefore the voucher amounts were set at \$75,000 for the hybrid bulldozer and \$28,500 for the hybrid excavator.

The equipment purchased with the voucher dollars is located in 14 locations throughout 7 California Air Districts. Because of the experience gained with the hybrid bulldozers purchased through the AQIP program, testing participants have already purchased, or plan to purchase additional hybrid D7E dozers even without the benefit of public incentives. While no hybrid excavators have been purchased without public incentives for use in California, two have been purchased for use in Arizona and New Mexico. It is anticipated that hybrid excavator sales in California will increase as the economy improves.

### **2.2 Fund distributions**

Project voucher recipients are identified in Table 2-1. Vouchers were provided for 16 equipment pieces from 2 manufacturers, for a total project voucher amount of \$901,578. Additional incentives were provided to fleets during the testing phase of this project to allow for equipment access and evaluation and for use of equipment operators. The total of testing incentives provided to fleet operators is \$183,500, for a total deployment and testing incentive of \$1,085,078 provided to participating California fleets. Of the 16 units deployed, 6 were used for emissions testing - 3 from Caterpillar and 3 from Komatsu. Table 2-2 provides an overall summary of the deployment dollars and the average equipment purchase price. The price of the equipment purchased for different locations and different operational purposes varied because of special options required for the anticipated usage.

**Table 2-1 Equipment deployment participants and monetary distribution summary**

<b>Purchaser</b>	<b>Facility Type</b>	<b>Hybrid Unit</b>	<b>Final Equipment Location</b>	<b>Voucher Number</b>	<b>Voucher Date</b>
Waste Management	Landfill	D7E	Corona, CA	01	9/21/2011
Orange County Water District	River Maintenance	D7E	Anaheim, CA	02	10/25/2011
Orange County Water District	River Maintenance	D7E	Anaheim, CA	03	10/25/2011
Diamond D General Engineering	Construction	HB215LC-1	Woodland, CA	04	10/26/2011
Road Machinery, LLC	Construction	HB215LC-1	Bakersfield, CA	05	10/26/2011
Republic Services, Inc.	Landfill	D7E	Anaheim, CA	06	12/16/2011
Republic Services, Inc.	Landfill	D7E	Chula Vista, CA	07	12/19/2011
Republic Services, Inc.	Landfill	D7E	Santee, CA	08	12/19/2011
Riverside County	Rock Quarry	D7E	Riverside, CA	09	12/20/2011
Republic Services, Inc.	Landfill	D7E	Half Moon Bay, CA	10	12/20/2011
Republic Services, Inc.	Landfill	D7E	Pittsburg, CA	11	12/20/2011
Clairemont Equipment	Construction	HB215LC-1	San Diego, CA	12	12/21/2011
Clairemont Equipment	Construction	HB215LC-1	San Diego, CA	13	12/21/2011
Road Machinery, LLC	Construction	HB215LC-1	Redding, CA	14	1/3/2012
Road Machinery, LLC	Construction	HB215LC-1	Sacramento, CA	15	1/3/2012
Waste Management	Landfill	Cat D7E	Lancaster, CA	16	12/6/2012

**Table 2-2 Overall summary of deployment vouchers and equipment purchase price**

<b>Vehicle Type</b>	<b>Vouchers Issued</b>	<b>Total Voucher Funds</b>	<b>Average Voucher Amount</b>	<b>Average Equipment Purchase Price</b>
Caterpillar Hybrid D7E Dozer	10	\$730,578	\$73,058	\$552,943
Komatsu Hybrid Hb215LC-1 Excavator	6	\$171,000	\$28,500	\$288,389
<b>Total</b>	<b>16</b>	<b>\$901,578</b>	<b>--</b>	<b>--</b>

### 2.3 Customer feedback

The overall impression of the hybrids from the fleets was positive. Most operators preferred the hybrid over the conventional equipment. On average, however, more positive comments about the excavator were received than about the bulldozer. Some fleets commented that the ease of control on the D7E was rougher than for the conventional due to lack of the declaring paddle. Also, the landfill operator commented that the D7E was too light relative to the conventional D8 dozer. The hybrid



excavator received some negative comments on the slowness of the upper body turning due to the hybrid design. **Error! Not a valid bookmark self-reference.** Table 2-3 summarizes fleet feedback and the purchase plans for the customers involved in the testing portion of the program. All of the negative feedback from Waste Management can be resolved by Caterpillar design engineers.

**Table 2-3 Feedback from testing customers and purchase plans**

Customer	Positive Feedback	Negative Feedback	Purchase Plans
Waste Management	Comfort Visibility Quietness Serviceability Speed Extended service intervals Remote-mounted AC unit with no hoses strung around the machine and no compressor in the engine compartment Ease of cleaning (easy to drop pans, easy to tilt cab) Easy to clean tracks on LGP with cut down track shoes FUEL ECONOMY!	Straight blade, Short trash rack, Final drives dragging in trash, LOW DRIVE!, Push-arm mounted grab iron / hand rail, Doors susceptible to damage from trash, Mounting methodology for idlers (blocks and shims), Air filter design, Fender enclosure latches (swing over compartments) get full of dust – become impossible to open, Steps mounted on push arm are too weak from factory, Tilt cylinder hoses are too short from the factory, Need guard for tilt cylinders on side of hard, nose, VERY difficult to inspect / adjust anything under the valve covers (have to pull hood, doors, DPF / after treatment system)	Has purchased 3 additional units and plan to purchase more in the future
Riverside County	Very happy as dozer has operated flawlessly	None	Not planning on purchasing any new dozers for a few years, but would definitely purchase another D7E if a dozer was needed
Orange County Water District	Operators love the D7E	None	Will buy another one next year
Road Machinery			None added to the California market but 2 units added for Phoenix and New Mexico markets. So a 75% dip in sales after the market crash for this 20 ton class of excavators. Expect sales to increase as housing starts increase.
Diamond D General Engineering	Believe they are seeing a 20% to 30% fuel savings with the hybrid. It is currently an advantage in some contract bids.		Looking at purchasing another unit within the year. Demonstration of prospective unit in process.
Clairemont Equipment	Customers are very happy with the power, performance, and ~15-20% fuel economy savings over machines in this weight class. For government and port improvement government contractors going green is a big incentive.	Because operators normally work based on the noise level of digging and swinging applications, emergency stop Komtrax alerts are seen almost every time a machine is delivered to a new customer.	No additional hybrids added but plan to add as the economy improves

### 3 Experimental

#### 3.1 Hybrid construction equipment description

This section provides a description of the hybrid Caterpillar bulldozer and the Komatsu excavator. The excavator utilizes energy recapture and storage during turning and is thus considered a true hybrid. The bulldozer does not have energy storage and is considered a hybrid based on the fact that the diesel engine is a generator of electricity that powers the bulldozer. Caterpillar bulldozer

The D7E bulldozer utilizes a diesel engine to power two electric drive motors that are directly connected to the D7E's undercarriage(see Figure 3-1, below). The electric drive system was designed to utilize a slightly lower displacement engine compared to the conventional D7R unit. The D7E is equipped with a 9.3 liter C9.3 ACERT Tier4 interim engine rated at 235 hp which replaces the D7R 10.8 liter Tier 3 CAT 3176 rated at 240 hp. The electric drive system allows the use of a narrow rpm range between 1500 rpm and 1800 rpm, instead of 1600 rpm and 2200 rpm for the conventional system. Because of this narrow rpm range, the power shifting transmission doesn't need to rev as high or lug down as low. Additionally the bulldozer has significantly fewer moving parts with the replacement of their mechanical gear system where 60 percent fewer moving parts are claimed.

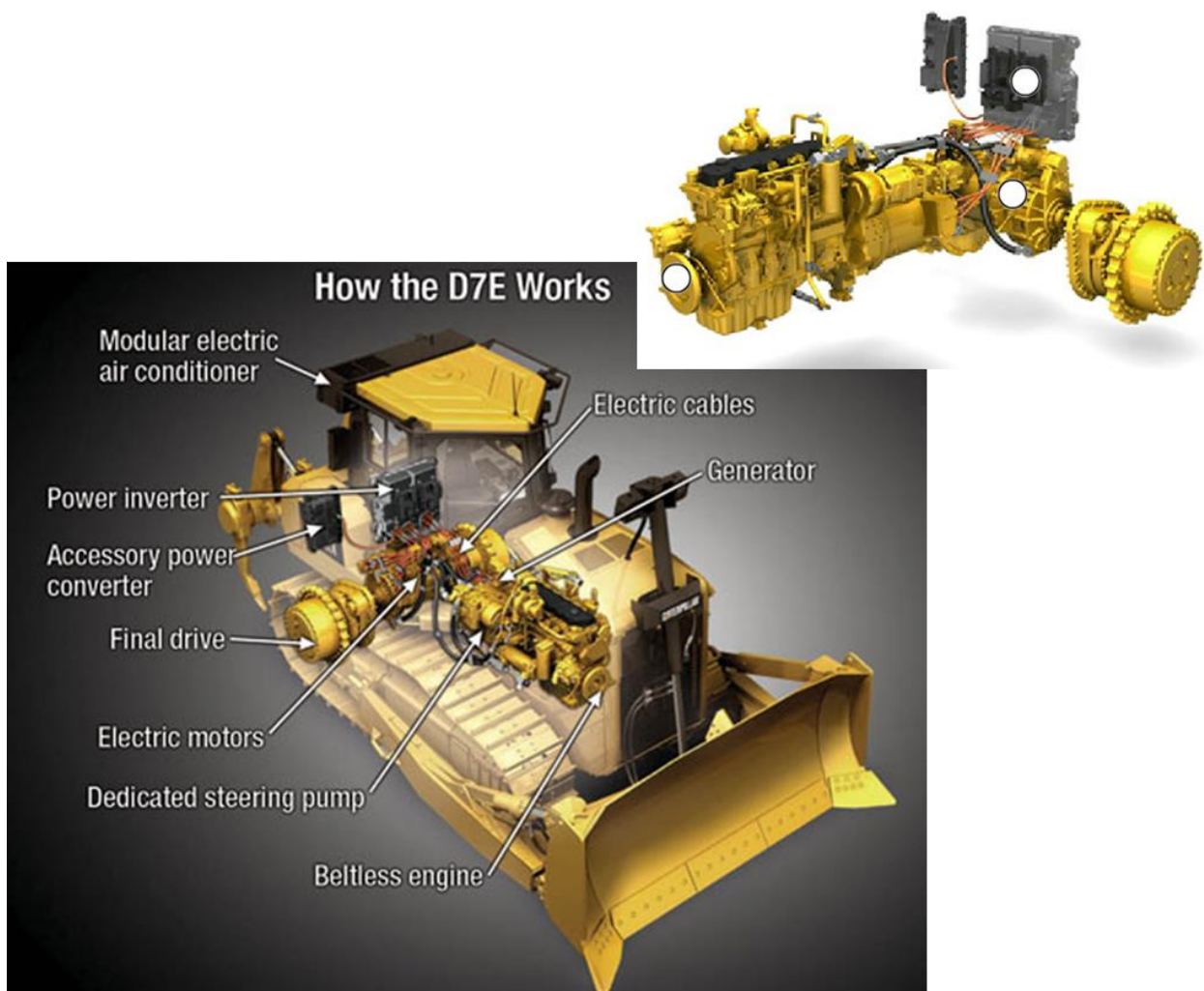


Figure 3-1 Schematic of Caterpillar D7E's Drivetrain Layout (Source: Caterpillar Inc.)

The Komatsu excavator utilizes an energy storage system which recovers energy from motion of the upper body swing (see Figure 3-2, below). The energy is stored in a capacitor that is then used to assist the engine acceleration via a power generation motor, thus less power is needed from the engine. Instead of a diesel engine for power and a hydraulic motor to turn the superstructure, the hybrid employs a diesel engine with an electric motor to “assist” at its flywheel, and an electric-swing motor to turn the superstructure (that also acts as, a generator), and a capacitor and pumps (see Figure 3-3, below). The rotational energy, that would otherwise be lost as the upper structure slows its rotation, is stored and is available to do work. As the swinging upper structure slows down, that kinetic energy is converted to electricity, which is sent through an inverter and then captured by a capacitor. The energy in the capacitor is available to power the superstructure swing-motor and to assist the diesel engine as it increases RPM or needs more torque for increased loading.

The hybrid drive utilizes a scaled down diesel engine. The non-hybrid excavator runs a 6.7 liter diesel engine rated at 148 hp, while the hybrid uses a 4.5 liter engine rated at 138 hp. The hybrid system allows the engine to operate at a lower idle speed of 700 whereas the conventional idles at between 950 and 1,050 rpm.

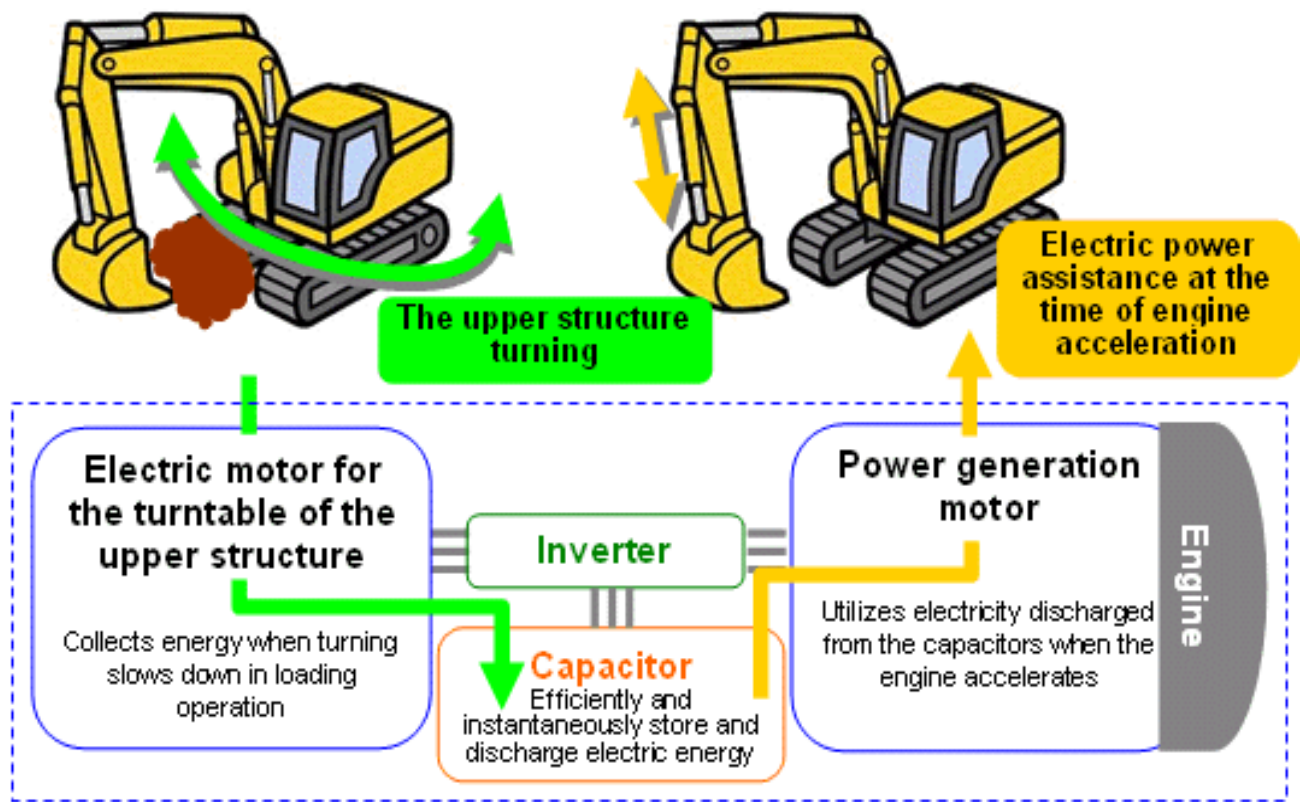
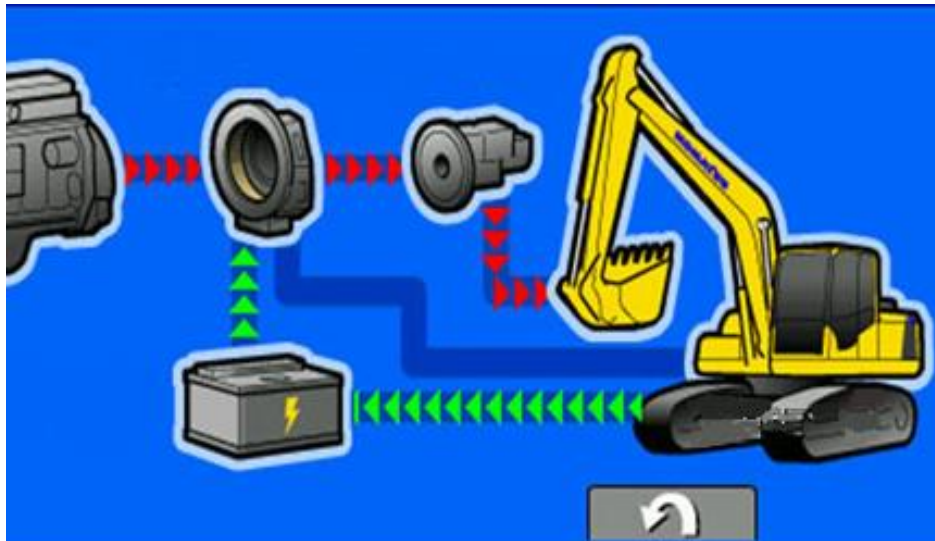


Figure 3-2 Schematics of hybrid System on Komatsu (source: Komatsu USA)



**Figure 3-3 Physical representation of the Komatsu hybrid excavator (source: Komatsu USA)**

### **3.2 Activity Data Collection**

Activity data collection required an assessment the participant’s equipment fleet, operational records, historical usage records, and in-use data collection. The first three steps provided the background necessary to plan for the in-use activity measurements. The inventory assessments identified what types of conventional units were available and their sizes (engine, blade, capacities...). The operational and historical records allowed for understanding maintenance, fuel usage, unit run time hours, and other information. Following these preliminary steps, the in-use activity measurements were begun. UCR collected activity measurements on both hybrid and conventional equipment for at least 20 days of video and three days for real-time engine and vehicle specific data. The duty cycle was then developed from the in-use activity measurements and interviews.

Activity measurements for off-road equipment included both physical work (P-work) and engine work (E-work). The physical work represents what is being pushed, lifted, or dug; and how it was done. The time stamp on the video was used to determine how long each activity was performed. The E-work captures the engine response to the load imposed by the P-work. The E-work is captured with real time ECM and GPS data loggers.

Two time-lapse cameras were mounted on each unit, (see Figure 3-4 for the Caterpillar bulldozer installation and Figure 3-5 for the Komatsu excavator installation). One camera was mounted on the front of the equipment and the other on the rear. The two cameras allow views of both front and rear operations to identify the type of work being performed in both directions. The cameras were battery operated and were programmed to record one frame everyone to ten seconds depending on the location. At a 10 second frame rate the batteries and 32 GB secure digital flash card would last well over three months.

From the P-work assessment, UCR was able to characterize the operation of the equipment and strategically install the ECM and GPS logger to record the E-work. It was important to capture the full range of operation expected. Through participant discussions and video reviews, UCR selected the appropriate days for ECM and GPS real time data logging to capture the various E-work modes described in later sections of the report.

The E-work was obtained using a beta version of the UniCAN Pro and GPS data logging system. See Figure 3-4 for the Caterpillar bulldozer installation. This system is a self-contained J1939 ECM

interface and data logging tool. It is rated for high temperatures and includes an integrated GPS. It was configured to start logging with key-on and stop logging with key-off. The UniCAN tool did not communicate with the CAT or Komatsu equipment out of the box, but with UCR development, the UniCAN was upgraded to send specific J1939 request messaging so it now works with 100 percent reliability with both the Caterpillar D7E and the Komatsu HP-215LC-1. This new tool greatly improved UCR's data capture success where OEM supplied diagnostic and maintenance tools, like the CAT ET, typically only capture 50 percent of the data due to logistical issues (e.g., stops logging on key-off and does not resume with key-on).



Figure 3-4 Activity measurement tools ECM, GPS, and time lapse video on the D7E



Figure 3-5 Activity measurement tools, ECM, GPS, and time lapse video on the HB215.

Table 3-1 shows the GPS and ECM real-time channels recorded for each unit. All of the channels in the list were requested, but only the black highlighted names were available and are part of this study. Percent torque (friction, actual, and reference) was not available on either the Caterpillar or Komatsu units, thus percent load was recorded instead. Since the torque values were not available, a lug curve was selected for the power calculation data presented in the results section. An official lug curve was requested from both Caterpillar and Komatsu, but only Komatsu provided an official lug curve. For this report, a nominal lug curve was used that is based on the maximum rated power of the engine and previous experience with the shape of the lug curves. Exhaust temperatures were also available for the Caterpillar engine because it had an aftertreatment system due to its Tier 4 interim designation.

**Table 3-1 Real time data logging GSP and ECM data recorded**

ECM Datalogging Configuration			
DATE	Altitude [m]	AccelPosition [%]	ThrottlePosition [%]
TIME	Latitude [deg]	EngineLoad [%]	BarometricPressure [kPa]
GPS_Second	Longitude [deg]	PercentDriverDemandTorque [%]	BoostPressure [kPa]
GPS_Minute	Valid_Fix	PercentActualTorque [%]	IntakeManifoldTemperature [°C]
GPS_Hour	Satellites	EngineSpeed [RPM]	EngineAirInletPressure [kPa]
GPS_Year	DOC_Tpost_C [C]	PercentFrictionTorque [%]	
GPS_Month	DPF_Tpost_C [C]	EngineCoolantTemperature [°C]	
GPS_Day	DOC_Tpre_C [C]	FuelTemperature [°C]	
Heading [deg]	DPF_deIP [kPa]	OilTemperature [°C]	
Speed_kmh [km/h]	DPF_status	FuelRate [L/h]	

### 3.3 Emissions Measurements

The primary purpose for the emissions measurement component of this study was to 1) quantify the changes in fuel economy and to 2) quantify the changes in emissions compared to a similar conventional equipment over real in-service duty cycles. The duty cycles were based on in-service operation as explained above and in Section 4. It was expected that the hybrid off-road equipment would show a benefit over the conventional, but there were some concerns about the measured in-use emissions benefits.

Gaseous and particulate matter pollutant emissions, ambient, GPS, and engine parameter data were measured with an on-board portable emission measurement systems (PEMS). The test fleet consisted of six participants - three for the Caterpillar D7E bulldozer and three for the Komatsu HB215LC-1 excavator. The emissions testing took place at each of the participant's facilities utilizing their trained operators. Testing was conducted between November 2012 and March 2013.

#### 3.3.1 PEMS Description

The PEMS equipment utilized in this research was compliant with federal test methods for in-use testing (40 CFR 1065) for the gaseous and PM systems. The gaseous PEMS is UCR's AVL gaseous PEMS called M.O.V.E.. The PM PEMS was UCR's AVL 494 system. An exhaust flow meter designed and manufactured by Sensors, Inc. was used with the M.O.V.E. system.

#### Gaseous PEMS

The specific AVL M.O.V.E. measurement principles are listed below for each pollutant:

- Oxides of nitrogen (NO and NO<sub>2</sub>) – non-dispersive ultraviolet radiation (NDUV). The NO<sub>x</sub> value is calculated from NO and NO<sub>2</sub> and reported on a NO<sub>2</sub>-equivalent basis.
- Carbon Monoxide (CO) – non-dispersive infrared radiation (NDIR)
- Carbon Dioxide (CO<sub>2</sub>) – NDIR
- Total Hydrocarbons (THC) – flame ionization detection (FID)
- Non-methane Hydrocarbons (NMHC) – not available, but is a calculated value and reported using  $NMHC = 0.98 * THC$

The THC is measured wet and all the others are measured dry and are corrected for moisture content through post processing for the AVL M.O.V.E.. The gaseous data is measured as a concentration and is time aligned and flow weighted to the exhaust flow for total mass reporting. All time alignment and flow weighting is performed as part of the post processor system for the PEMS.

The THC instrument requires a source of FID fuel that is a blend of hydrogen and helium. UCR used an external FID fuel bottle that is sufficiently sized for several weeks of testing to prevent possible THC data loss during operation.

### *PM PEMS*

In-use portable PM measurement systems are still in development and many of these systems have been demonstrated to be problematic and unreliable (1 - 19). As such, UCR chose a path that we feel is robust and will provide the program the best PM results.

The PM PEMS measurement system selected was AVL's 483 micro soot sensor (MSS) in conjunction with their gravimetric filter module (GFM) option. The combined system is called the AVL 494 PM system, and was released in mid-2010. The instrument measures the modulated laser light absorbed by particles from an acoustical microphone. The measurement principle (called photo-acoustic) is directly related to elemental carbon (EC) mass (also called soot), and has been found to be robust and to have good agreement with the reference gravimetric method for EC dominated PM.

The MSS 483 measurement principal does not detect total PM mass, since soluble organic fractions, ash, inorganic, sulfates and nitrates would not be detected. As such AVL introduced the GFM and a post processor that utilizes the filter and a soluble organic fraction (SOF) and Sulfate model to estimate total PM from the soot and gravimetric filter measurements. At a minimum, one gravimetric filter is sampled per day and continuous PM concentration is recorded at 1 Hz. The combined MSS+GFM system recently received approval by EPA as a total PM measurement solution for in-use compliance testing, thus making it one of the few 1065 compliant PM PEMS systems.

### *Flow meter*

The exhaust flow meter (EFM) used was Sensors Inc.s High Speed EFM (HS-EFM) The EFM works with the wide range of exhaust flows and dynamics of transient vehicle testing. The exhaust flow uses differential pressure as its measurement principle. An appropriate exhaust flow meter was selected to match the displacement of the engine being tested.

### *3.3.2 Data Collected*

#### *Pollutant emissions real time and integrated data*

- NO<sub>x</sub> (measured as NO and NO<sub>2</sub> and summed for NO<sub>x</sub>)
- PM (MSS 494 based PM)
- THC
- CO
- CO<sub>2</sub>



### *Engine parameter real time and integrated data*

- Engine speed (revolutions per minute, rpm)
- Engine intake air temperature (only with ECM if broadcast)
- Engine intake manifold air pressure (only with ECM if broadcast)
- Engine exhaust temperature
- Engine exhaust mass flow rate
- Engine fuel consumption (only with ECM if broadcast)
- Engine % load (only with ECM)

### *Other real time and integrated data*

- Ambient temperature
- Relative humidity
- Barometric pressure
- Date/time stamp
- GPS position, speed, elevation, and others

### *Other integrated data*

- Surface dryness, grade, and roughness
- Media moisture, density, and weight

### *3.3.3 Test Units*

The hybrid units and their conventional equivalent units used for the comparison are described in this section. The hybrid D7E bulldozer did not have a direct conventional, late model non-hybrid equivalent, and older model equipment did not have the same tier level, which could affect the overall comparison. For the excavator, the manufacturer suggested the PC200 was the best choice, but industry stakeholders also suggested the power of the PC220 might be a good replacement since its capacity was very close to that of the hybrid.

#### *Bulldozer comparisons*

Several unit types were considered for emission testing to provide an “apples to apples” comparison with the Caterpillar hybrid D7E Tier 4i. The ideal conventional bulldozer would be a similar size D7 with the Tier 4 interim (T4i) emissions package; however this product was not available from the manufacturer. Given that there are no direct conventional equivalents to the D7E T4i hybrid bulldozer, UCR explored options for the baseline comparison. These options vary with each participant and depend on equipment availability.

Table 3-2 shows a list of conventional bulldozers in sizes similar to the D7E bulldozer. The Caterpillar D7E Tier 4i bulldozer includes a 252 brake horsepower (bhp) Cat C9.3 (9.3 liter) diesel engine that drives a generator to produce electricity that runs to a power module, where it is inverted to AC current. The engine is equipped with an aftertreatment system (ATS) which is designed to reduce PM, THC and CO emissions. The D8T Tier 4i bulldozer is a larger piece of equipment with mechanical drive and a larger 348 bhp C15 (15.2 liter) ACERT engine equipped with a similar ATS. The D6T Tier 4i bulldozer is a smaller piece of equipment with mechanical drive like the D8T, but with a smaller 229 bhp C9.3 ACERT engine equipped with a similar ATS. The D7E utilizes the same C9.3 engine as the D6T, but is rated at a slightly higher power at a lower engine speed.

The D7E, D6T, and D8T are available with ATS. The D7R is only available as a Tier 3 product and older (Tier 2, 1, ...) and is not available with an ATS, thus no D7 conventionals were included in

this study. According to WM the D7E replaced their D8R's, so the Tier 2 D8R was also tested since it was in operation at the landfill and was available.

**Table 3-2 Hybrid and conventional bulldozer available for this evaluation**

Unit Model n/a	Engine Model n/a	Year n/a	Engine		Gross	
			Hour hr	Displacement liters	Power Hp	ATS n/a
D8R T2	3406E	2003	17149	14.6	348	n/a
D6T T4i	ACERT <b>C9.3</b>	2012	24	9.3	229	DOC/DPF
D8T T4i	ACERT <b>C15</b>	2012	600	15.2	348	DOC/DPF
D7E T4i	ACERT <b>C9.3</b>	2011	2528	9.3	252	DOC/DPF
D7E T4i	ACERT <b>C9.3</b>	2011	573	9.3	252	DOC/DPF

<sup>1</sup> Two D7E's tested one with 2582 hours and one with 573 hours

<sup>2</sup> The D7E-T4i, D6T T4i, and D8T 4i are tier 4 interim bulldozers with a Diesel Oxidation Catalysis (DOC)/Diesel Particulate Filter (DPF) equipped engines. The D8R is a Tier 2 certified engine that has been rebuilt.

In summary, the emission tests performed in this study were based on two D7E T4i, one D8T T4i, one D6T T4i, and one D8R T2. The D8R-T2 was selected to provide information for the benefit when replacing older aging equipment and due to its availability at the landfill. The D7R was not tested because the lack of an ATS and older tier level would drastically affect the PM, CO, THC, and NOx and possibly fuel consumption benefits. The D8T T4i and D6T T4i were available as a rental, but were not configured for a trash blade or special undercarriage and therefore could not be tested in the trash or the riverbed for actual in-revenue service. UCR did compare the D7E-T4i and D8R-T2 during in-revenue service at the landfill as described later in this report.

#### *Excavator comparisons*

The Komatsu conventional excavator comparison is more straight-forward than for the bulldozer. The HB215LC-1 hybrid package is the hybrid version of the conventional PC 200. Both the hybrid and the conventional are tier 3 products. Furthermore, a few of our project participants suggested the slightly more powerful PC220 would also be a good comparison. The PC220 is also a tier 3 machine which has the same engine model as the PC200. For a list of comparable Komatsu excavators see Table 3-3.

The Komatsu HB215LC-1 hybrid excavator includes a diesel engine, electric motors, inverter, and capacitor energy storage device. This design is significantly different from the Caterpillar approach, where energy generation (storage) occurs when the upper structure reduces its speed while turning. The energy is stored in the capacitor and is used to turn the upper structure (which is powered by an electric motor/generator) and to assist the engine via the power generation motor when the engine speed accelerates. The conventional excavator design uses only the diesel engine for power, whereas the hybrid excavator also utilizes regenerated energy to assist the engine when it is accelerating, enabling the use of the engine in a low revolution zone with high-efficiency combustion. In addition, while the engine idles, the hybrid excavator optimizes operation for minimal fuel consumption.

**Table 3-3 Available Komatsu excavators comparable to the hybrid HB215LC-1**

Unit Model n/a	Engine Model n/a	Displacement liters	Year n/a	Engine Hour hr	Gross Power Hp	Electric Power n/a
HB215 T3	SAA4D107E-1	4.5	2011	245	148	yes
PC200 T3	SAA6D107E-1	6.7	2007	2097	155	n/a
HB215 T3	SAA4D107E-1	4.5	2011	736	148	yes
PC220 T3	SAA6D107E-1	6.7	2006	2228	180	n/a
PC220 T3	SAA6D107E-1	6.7	2006	3516	180	n/a
HB215 T3	SAA4D107E-1	4.5	2011	280	148	yes
PC200 T3	SAA6D107E-1	6.7	2010	1228	155	n/a

<sup>1</sup> Two PC200's tested the other was a 2007 with 2097 hours, two PC220's tested both 2006 and one with 3516 hours, and three HB215's tested all were 2011's, but with 245 and 736 hours

### 3.3.4 Engine/Equipment Inspection

Proper equipment operation is a critical element of ensuring good results for the emissions testing. Some of the equipment tested was new, with only a few hours of accumulation, and others were older (both conventional and some hybrid), with up to a thousand or more hours accumulated. Prior experience has shown that in-service equipment that is not operating correctly will not provide good emissions benefit comparisons. Thus, it was critical to make sure both the hybrid and conventional equipment were operating properly. This was accomplished through a series of inspections with each fleet.

The engines and equipment were inspected visually just prior to emissions testing to collect data about conditions that might affect engine emissions. Engines were checked for visible exhaust leaks, and other problems that could affect or jeopardize results, such as excessive fuel or oil leaks. An example vehicle owner questionnaire and engine inspection form is provided in Appendix H.

### 3.3.5 State of Charge Determination

Hybrid emission comparisons are not straight forward and require special attention to the state-of-charge of energy storage devices. The Caterpillar system does not have an electrical storage device. Thus, for the Caterpillar testing, state-of-charge determination is not necessary. The Komatsu hybrid system employs an electrical capacitor energy storage system. According to SAE J1711 (4) and SAE J2711 (5), these energy storage systems need to be monitored for similar state of charge before and after testing. However, due to the fact that the Komatsu excavator only uses its power storage device (ultra-capacitor) for short bursts of power, state of charge will never be an issue over an entire test cycle. In other words, its state of charge fluctuates widely over a short time (on a time scale of seconds to minutes) compared to the length of a test cycle. Therefore it was not necessary to monitor state of charge of the excavator's ultra-capacitor.

### 3.3.6 Test Fuel

The test units were fueled with 'red-dye' off-road CARB ultra-low sulfur diesel (ULSD) fuel. This fuel is similar to on-road CARB ULSD with the addition of red dye to make a distinction between on-road and off-road fuel.

### 3.3.7 Quality Control

Quality control is necessary for any measurement campaign and is especially important for field PEMS emissions testing. The quality control checks are broken down into evaluations of gaseous, PM, exhaust flow and other measurements. For each category a series of Standard Operating Procedures (SOP) have been developed for proper and consistent operation based on the best recommended practices in the PEMS industry. These SOP's cover checks and verifications for the equipment which include pre-test, setup and installation, equipment start up, in-use, and post-test. Appendix E has a complete list of SOP's utilized for the field PEMS emissions testing.

#### *AVL M.O.V.E.*

The gaseous PEMS software comes with built in QC procedures for all their gaseous measurements (CO, CO<sub>2</sub>, NO<sub>2</sub>, NO, and THC). These included daily pre- and post-test zero, span and audit gaseous emissions checks. All zero check calibrations were performed on zero gas to help improve the quality of the data.

Gaseous analyzer linearity is required by 1065 on a monthly basis. UCR has an in-house 1065 audited gas divider that was used to perform this procedure. In addition, leak checks were performed for each setup change or other change to the plumbing system. Sample filters were replaced as needed and different system pressures were monitored prior to testing to prevent invalidating a test due to a failed component. The gaseous PEMS system has a system ready indicator that lets the user know that the system is ready for operation, and this was verified prior to its use.

#### *AVL PM PEMS 494 (MSS+GFM)*

The PM system requires verification of its micro soot signal and gravimetric filter system. The micro soot sensor detection system has a calibration procedure that is used to maintain consistency between testing campaigns. The PM calibration procedure was performed prior to each testing campaign. In addition, routine linearity checks were performed along with each calibration, as recommended by the manufacturer. The daily checks included leak checks, pollution window level checks, and zero checks. Daily leak checks are performed due to potential issues with leaks around the GFM system.

The AVL system requires annual calibration of its many flow, pressure and temperature transducers, which were recently performed by UCR as part of our annual system inspection. This inspection was performed prior to its use in this testing campaign. During testing, where possible, these measurement systems were verified against local airport records for accuracy and consistency.

The UCR filter weighing chamber meets 1065 requirements and was maintained throughout the course of this testing effort. The requirements include calibration of balance temperature, pressure, and relative humidity. The UCR micro balance is certified annually by an outside source and was valid during the course of this testing operation.

#### *Sensors, Inc. EFM*

The manufacturer recommends that the exhaust flow meter be recertified twice a year. Experience has shown that the EFM accuracy is similar to UCR's mobile emissions laboratory (MEL) CVS by difference method. It is expected that the accuracy of the EFM does not tend to drift over time. Thus, an in-house verification was performed against UCR's MEL both prior to testing and after all testing had been completed. The UCR MEL is routinely verified using propane verifications. The flow check provided a good metric that the EFM did not drift or deviate from its starting calibration over the course of the emissions measurement task.

### *Other Information*

Other measurements that were verified included ambient temperature, RH, and barometric pressure. These measurement systems were verified against local airport records for accuracy. No additional calibrations or verifications were performed, except their annual calibration.

#### *3.3.8 Data Processing*

##### *AVL M.O.V.E.*

All gaseous, exhaust flow, ECM, and ambient data were analyzed and post processed using the manufacturer's supplied post processors. The calculation methods used were suitable for in-use off-road regulations. This included NO<sub>x</sub> humidity correction factors that follow CFR40 Part 1065.670. For other calculations, such as time alignment, the manufacturer's recommendation and in-house experience were used. At any point data can be re-analyzed and time alignment issues corrected since the raw data is un-affected.

##### *AVL PM 494 PEMS*

The AVL MSS+GFM system is a relatively new system and the post processor is still evolving. As such, all data were processed with the latest version of the post processor called "Concerto". The total PM measurement system can be configured to utilize THC, exhaust temperature, fuel sulfur levels, and other parameters for total PM mass modeling. PM, as reported by the MSS system, gravimetric filter mass, and the total PM mass (MSS + modeled), is provided when possible. The gravimetric filters were weighed using UCR's standard practices for gravimetric filters and balance conditions following 40 CFR 1065.

## 4 Activity Results

This section covers the results for both the Caterpillar bulldozers and the Komatsu excavator. The results include the hybrid and conventional equipment activity measurements.

### 4.1 Caterpillar

The Caterpillar bulldozer measurements were made at three facilities, Waste Management (WM), Orange County Water District (OC), and County of Riverside Transportation Department (RC). WM represents a land fill operation, OC represents a water district, and RC represents a rock quarry for maintaining public roads. WM is a private fleet and operates around the clock six days a week; OC and RC represent public fleets and operate their equipment at Monday through Thursday from 6:00 AM to 3:00 PM.

WM maintained unit specific fuel records where we were able to agree within 5% of UCR's in-use activity fuel usage measurements over a relatively common interval.

#### 4.1.1 Interview data

This section covers highlights from questionnaires asked of each of the participants. This covers fuel usage, maintenance, operational uniqueness, and seasonal effects. The interviews are organized by participant. For more details on participant interviews see Appendix A

##### *Waste Management (WM) physical activity*

Five primary types of activity were observed in the D7E videos from WM. These include spreading trash, spreading dirt, building roads, walking the floor<sup>1</sup>, and building the ops layer<sup>2</sup>. WM uses the D7E in a slightly different way than the conventional bulldozer it has replaced. This is due to its ease of operation and speed. As such the D7E has become a “jack of all operations” as far as bulldozers are concerned. The conventional D8 has been observed mainly pushing trash. This was considered in the final development of the test cycle. The data analyzed represents all activities, but the dominant operation of landfills is spreading trash and dirt, it will be the focus of the analysis. WM shows some idle operation and is estimated to be on the order of 15% based on operational records provided by WM for several of their bulldozers. For more information on the modes and operations for WM see Figure A1 in Appendix A.

##### *WM Seasonal effects*

The El Sobrante Landfill of WM is not affected by seasonal conditions. The dominate input to the landfill is consumer trash and is not tied directly to industry (like construction). The landfill sees a slight increase around holidays like Thanksgiving and Christmas but it is not a significant impact.

##### *County of Riverside Transportation Department (RC) physical activity*

The primary work for the D7E at RC is preparing building material (“cold mix”) from county owned rock quarries. This involves cleaning weeds off the ground, making roads for trucks, and pushing the fine rock/dirt mixture up on a large pile. After going through the D7E videos, there are two primary locations where all the bulldozer activity is observed. The activity study started at the Benton site

---

<sup>1</sup> “Walking the floor” refers to when the bulldozer is used to smooth the surface of the dirt, primarily using its treads. The blade is also used with a very light touch to spread dirt for filling irregularities in the surface before the treads lightly pack the surface.

<sup>2</sup> “The ops layer” is a layer of dirt, approximately 2 feet thick, that is laid over the liner at the bottom of the trash pit. The ops layer protects the liner from being penetrated by sharp objects in the solid waste.

near Temecula, California; about a week later the bulldozer moved to the Juniper site near Homeland, California. Since the Juniper pit is a relatively newer pit than the Benton pit there is more site preparation as compared to Benton site. A third type of operation observed at RC was long periods of idle. An “extended idling” mode was created for the cycle development, since it was believed that this mode would be important in other industries that use the D7E. See Figures A6 and A7 in Appendix A for visual representation of modes and operations.

#### *RC Seasonal effects*

RC does not have a distinct seasonal effect since their operation is road maintenance which is required all year round. They may have some slowdown in the winter months as the earth is too damp to work on, but it is short term. Thus, RC is a continuous operation throughout the year.

#### *Orange County Water District (OC) physical activity*

The primary work at OC is to replenish the ground water supply by managing approximately 20 miles of the Santa Ana River. This involves building a longer flow path (i.e., building a levee maze in the river bed), building multiple off-river water basins, and maintaining the permeability of the river beds and basins. The ultimate goal of these efforts is to preserve ground water and prevent fresh water from reaching the ocean. According to the D7E videos for OC, there are two primary locations where bulldozer activity occurs. The D7E is either doing work on the river bed or in the drained water basins. Thus, OC D7E activities were divided into those two main categories. See Figures A3, A4, and A5 in Appendix A for visual representation of modes and operations.

#### *OC Seasonal effects*

OC has a very distinct seasonal operation. Summer and fall seasons are their busiest months when most of the river drainage, storage ponds, levies, and mazes are repaired. The analysis presented here is based on their busy month.

#### *4.1.2 Development of event data*

The development of the bulldozer duty cycle required developing events, behaviors, or a combination of both, so this was the primary focus of the analysis of the activity data. It was quickly discovered that the bulldozer behavior is very clear with its forward and backward movements. Figure 4-1 shows the GPS location of the bulldozer overlaid on a Google map satellite image. The figure shows the bulldozer movement for the 48,000 seconds that it operated on this particular test day. Figure 4-2 shows the same data, but focused from 24,000 to approximately 26,000 seconds. The detailed figure shows that the dominant motion is forward and backwards as seen by the straight lines in Figure 4-2.

GPS data was used to provide a real-time heading where a change in direction from forwards to backwards was very easy to calculate and was a reliable metric to determine bulldozer events. Figure 4-3 shows the bulldozer’s real time GPS signal for heading in degrees. The heading is a degree from 0 to 360 representing a circle. Going from 1° to 359 ° is actually only 2° of difference for a 360° circle, but going from 1° to 181° is reverse in direction. From Figure 4-3 one can see the heading degree change from 360° to 120° degrees. Each change represents a change in direction as shown by the straight lines in Figure 4-2. In order to calculate an event, the difference in degrees was calculated which is plotted in Figure 4-4. Every spike in degree represents a change in heading. This is true as long as the heading difference is greater than 100° but less than 300°. See Appendix B for more details of issues with heading calculations and data filtering. In general, all the events presented in this report are based on changes in heading direction.

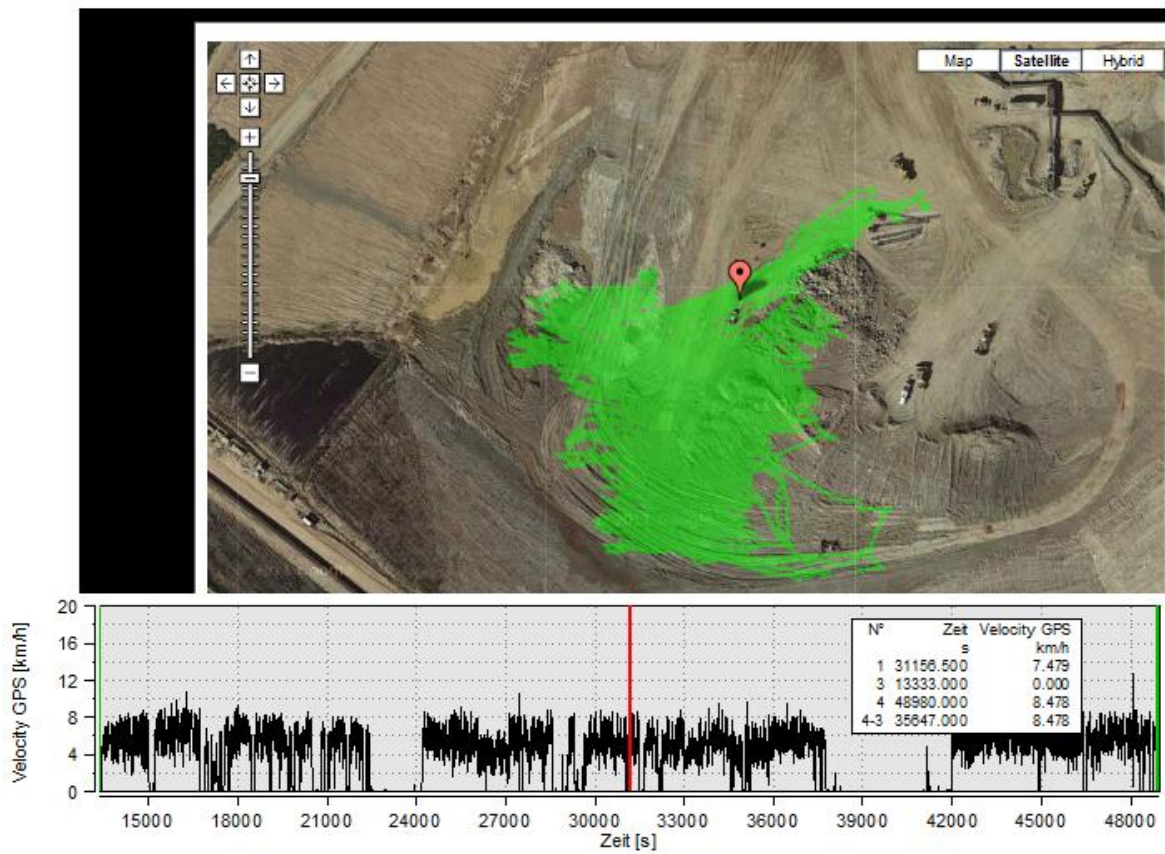


Figure 4-1 GPS overlay onto Google Maps to show physical in-service activity

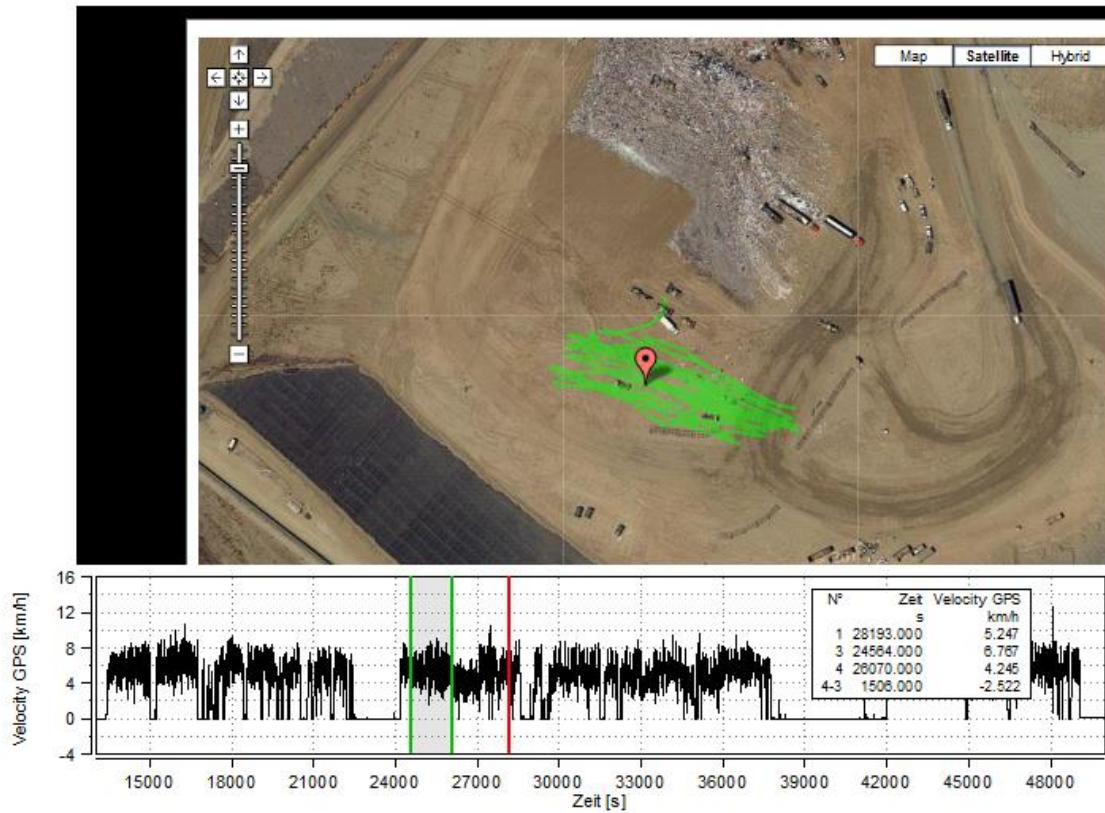
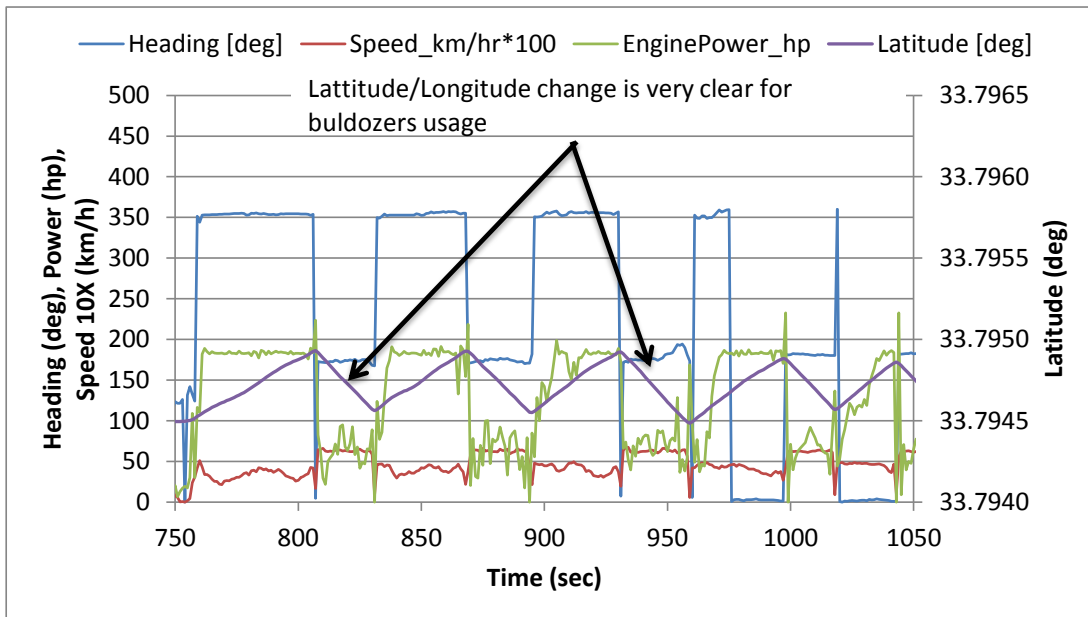
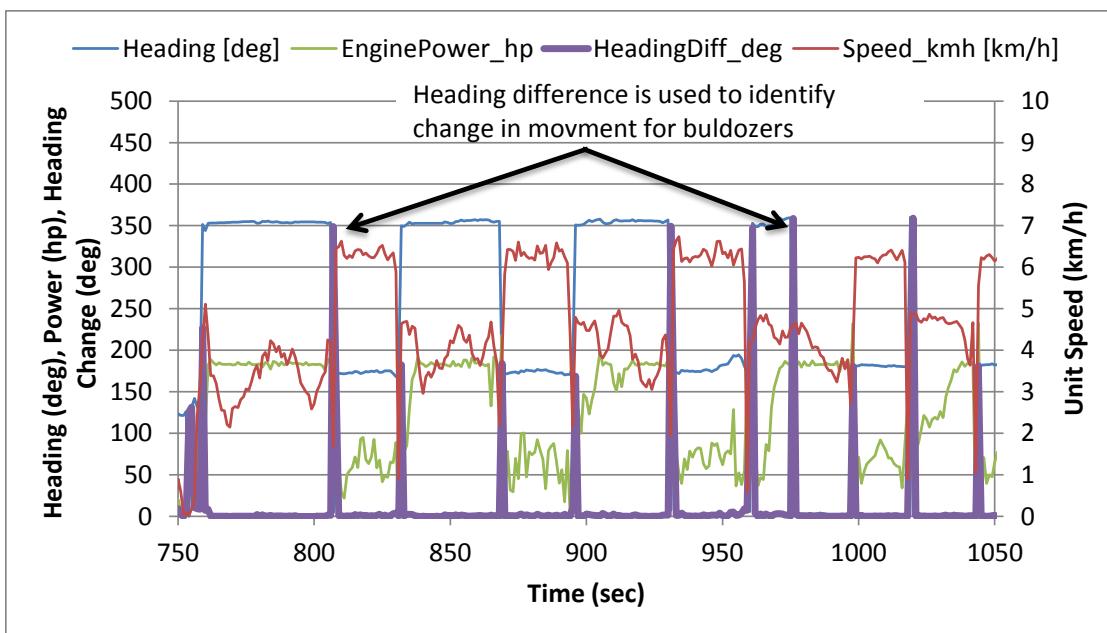


Figure 4-2 Same as above except zooming in to time ~24000 to ~26000 data points





**Figure 4-3 Bulldozer GPS and ECM event results for typical pushes and pulls**



**Figure 4-4 Bulldozer event identification using heading change**

Video was used to visually record the actual mode of operation and to determine the fraction of time each mode was used. The video equipment was left on each machine for at least four weeks and up to as long as eight weeks. During this time a video frame was captured every one to five seconds 24 hours per day for WM and 9 hours per day for RC and OC. Using the video combined with participant discussions, numbers were assigned to each mode of operation. Table 4-1 shows a list of the modes used during the activity monitoring. Mode 1 represents pushing and spreading trash at WM and mode 8 is pushing wet material in the Santa Ana River for OC. A more detailed description for all the modes is presented in Appendix A.

**Table 4-1 Mode identification for all documented modes for WM, RC, and OC**

Mode	Facility	Description	Mode	Facility	Description
x	All	Unknown	6	RC	prep site
1	WM	pushing trash	7	RC	pushing pile
2	WM	pushing dirt	8	OC	wet river push
3	WM	building ops layer	9	OC	dry river push
4	WM	walking floor	10	OC	dry pond push
5	WM	building roads	11	OC	preparing sides

The video was also very useful in determining how much time was spent in each mode. The video captured approximately 320 hours of valid activity at WM and 80 and 60 hours for OC and RC respectively. More video was recorded for WM due to their 24 hour per day 6 days a week operation and because the cameras were installed longer. A record of the times spent in each mode was documented by watching the video. Hours where the equipment was not moving and obviously parked were not counted.

#### 4.1.3 ECM and GPS

The real-time activity measurement campaign captured over 600,000 seconds (167 hours) of data for the D7E and D8R bulldozers. Table 4-2 shows the data collected for each participant and for each bulldozer type. The data collection for OC, RC and WM was fairly even with over 190,000 seconds recorded at OC, 137,000 at RC and over 199,000 at WM. The net data collected is based on valid GPS signals where OC showed over half of the data as invalid due to poor GPS signals (valid GPS fix and acceleration > 10 km/hr). WM and RC only showed very little filtering, where less than 5% of the data was removed, see Table 4-2. The data removal from WM and RC was also due to poor GPS signals. See Appendix B for more details on data filtering and reductions.

**Table 4-2 Data records collected for each participant for the D7E and D8R.**

Data ID	Rows				
	valid fix	accel>10	gross	net	% filt <sup>1</sup>
ALL	120403	40	532149	41170	23%
OC	110140	9	194659	84510	57%
RC	6381	9	137709	13131	<5%
WM	3882	22	199781	19587	2%
WMD8_GPS	6654	3	61182	54526	11%
WMD8_CAT_ET	2192	4	24430	22234	9%
Total	129249	47	617761	193988	

<sup>1</sup> Percent of data filtered from the second by second data.

Once the data was analyzed for second by second consistency, the events were grouped and filtered for proper event identification. Table 4-3 shows the number of events identified for each participant and unit tested. WM showed the most events at over 8,000 and OC and RC were about the same at near 2,000 each. The D8R events were identified for two cases, as shown in Table 4-3 “\_GPS” and “\_CAT\_ET”. The activity tools designed for the D7E did not work on the D8R and thus we had to use CAT ET, a commercially available system purchased from Caterpillar. This system stopped recording every time the D8R was keyed-off, and as such significant amounts of data were lost. It

was decided to repeat the measurements for the D8R with GPS only tools “\_GPS” in order to capture more GPS events. Thus the statistics presented are based on two separate measurement tools for the D8R, see Appendix B for more details of filtering issues for the D8R.

**Table 4-3 Event records collected for each participant for the D7E and D8R**

Data ID	BSFC	Events		
		gross	net	% filt <sup>1</sup>
ALL	26	12049	12023	0.2%
OC	0	1652	1652	0.0%
RC	5	1901	1896	0.3%
WM	21	8495	8474	0.2%
WMD8_GPS	0	1433	1433	0.0%
WMD8_CAT_ET	0	606	606	0.0%

<sup>1</sup> Percent of data filtered from the events.

An idle mode was created to account for idle time and because the other modes do not include idle. Any data of more than 5 seconds of continuous idle was flagged as an idle mode, see Appendix B for more details on idle identification. Thus, the events identified in Table 4-3 do not include idle time greater than 5 continuous seconds and represent events with load. This approach was necessary in order to quantify the event statistics properly and to develop the proposed duty cycles. This approach is also used for on-road cycle development since idle can greatly skew statistical results and needs to be treated separately [3, 6].

Percent time at idle are shown in Table 4-4 for each of the participants and all the units tested. Percent idle time ranged from 14% for WM to 20% for OC. WM survey records show 15% of the bulldozers operation is idling, which agrees well with our activity measurements. Due to the high level of idle for each of the participants, an extended idle time was proposed as one of the test cycle modes.

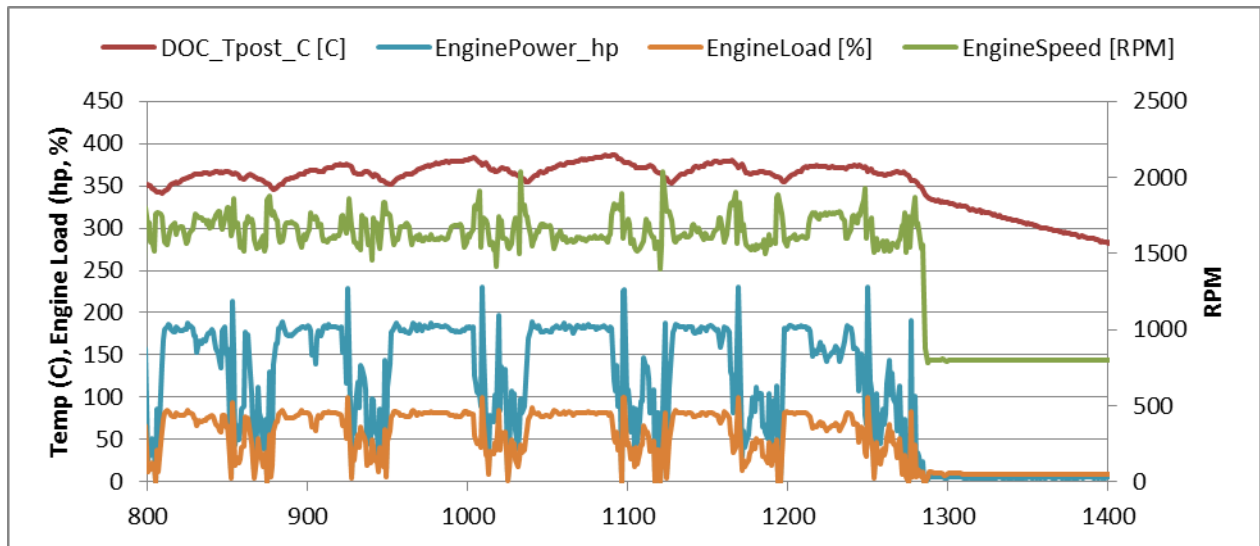
**Table 4-4 Idle time as measured during activity assessment for each of the participants <sup>1</sup>**

Description	WM		WM		OC		RC	
	hr	%	hr	%	hr	%	hr	%
total idle	7.6	14.0%	0.7	11.7%	4.8	20.1%	5.5	15.1%
idle<900	3.4	6.3%	n/a	n/a	3.8	15.9%	4.9	13.5%
900<idle<1350	1.0	1.8%	n/a	n/a	0.3	1.1%	0.2	0.6%
idle>1350	3.2	5.9%	n/a	n/a	0.7	3.1%	0.3	0.9%
total time	54.4		6.2		23.8		36.5	

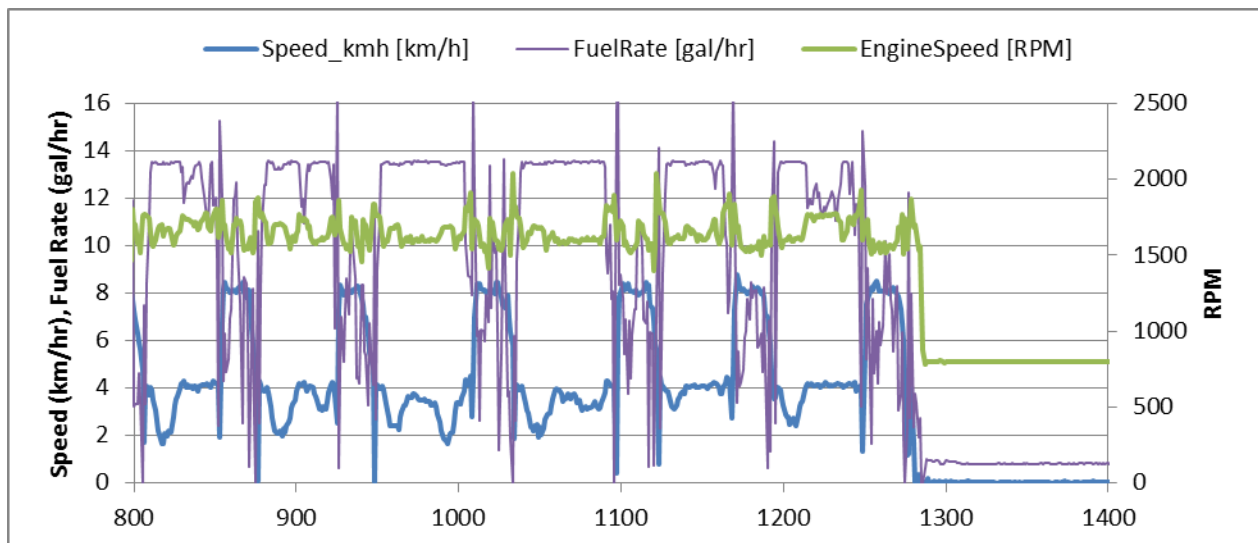
<sup>1</sup> Idle determination is explained in Appendix B

Typical ECM data for the D7E bulldozer is shown in Figure 4-5 and in Figure 4-6. Figure 4-5 shows the engine power, percent load, engine speed (rpm), and catalyst exit temperature. Figure 4-6 shows the unit speed in km/hr and fuel rate in gal/hr. The power and fuel consumption are highest during a “push” (moving material) and lowest between events when the bulldozer prepares for the next push. The term used for time between pushes is called a “pull” (returning from pushing). The push is associated with the high power and high fuel consumption event (80% load and 180 hp and 13.5 gal/hr) and the pull is associated with a lower power and low fuel consumption event (60 hp and 7 gal/hr). The D7E never reached 100% load as shown in Figure 4-5 which is also true when the full data set is considered. Engine speed is relatively constant as the D7E has a PTO and is typically set at 1700 rpm (rated power). The catalyst temperature is stable at around 350°C during the push and

pulls. When power increases the fuel rate increases as one would expect. The unit speed is lowest during a push (3.5 km/hr) and highest during a pull (8 km/hr). This agrees with explanations of bulldozer operation where operators are trained at pushing piles until the unit stalls, or slows, and then the blade is trimmed to maintain a full power throughout the push. Thus, a trained operator moving large amounts of material should produce the traces in Figure 4-5 and Figure 4-6 for a D7E.

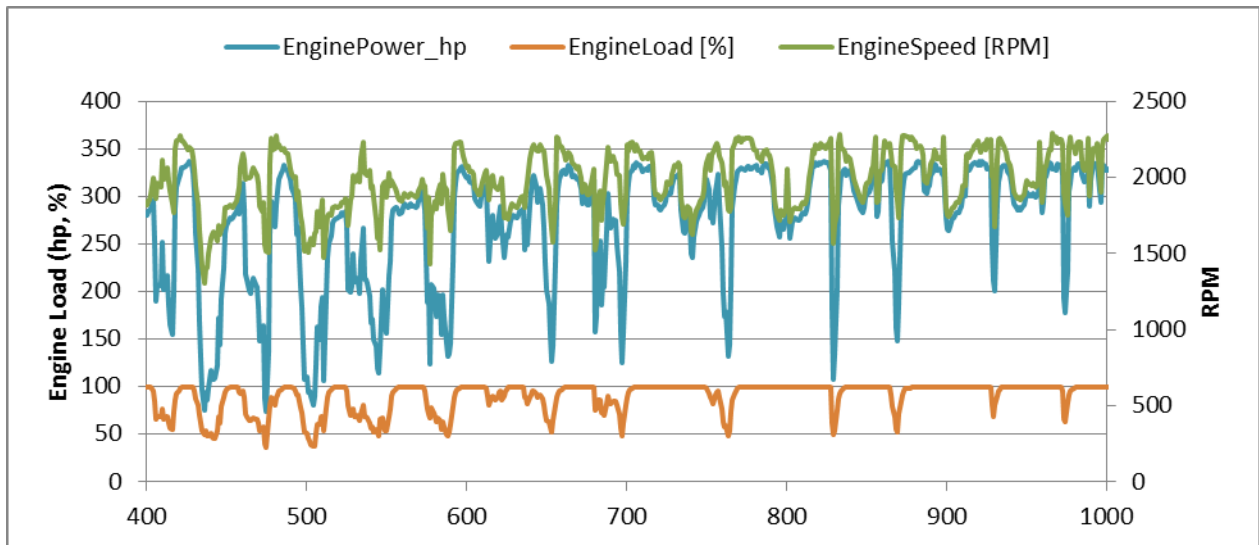


**Figure 4-5 Typical engine power, % load, rpm and catalyst exit temperature for a D7E**

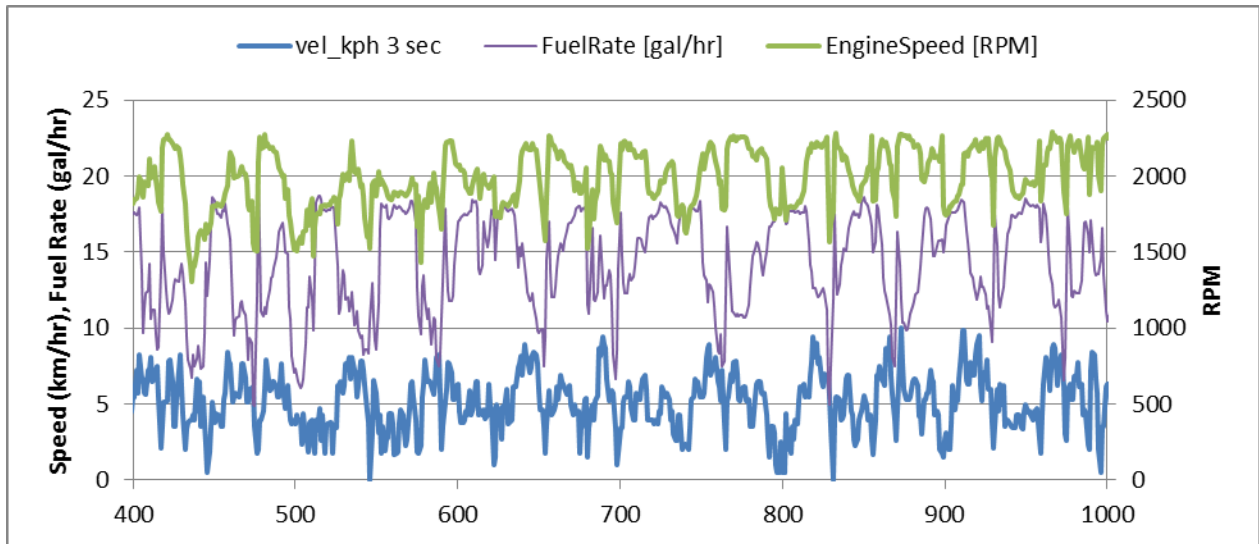


**Figure 4-6 Typical unit speed, fuel rate, and rpm for a D7E**

The typical ECM data for the D8R bulldozer is shown in Figure 4-7 and in Figure 4-8. Figure 4-7 shows the engine power, percent load, and engine speed (rpm) and Figure 4-8 shows the unit speed in km/hr and fuel rate in gal/hr. The D8R shows 100% load for its pushes, but with much more variable engine speed. This agrees with literature on the gear driven D8R and the electric drive of the D7E. The unit speed (km/hr) of the D8R is lower than the D7E during pulls, but is about the same during pushes. The power and fuel consumption of the D8R are higher than the D7E given that the D8R has a larger engine and is a bigger machine.



**Figure 4-7 Typical engine power, % load, and rpm for a D8R**



**Figure 4-8 Typical unit speed, fuel rate, and rpm for a D8R**

#### 4.1.4 Characterization of time fractions spent in different modes

The number of hours and the percentage of time spent in each mode were calculated for both the video and ECM results. Figure 4-10 shows various modes of operation captured with the time lapse video systems. The summarized results are presented in Table 4-5. Figure 4-10 also shows the percent for the ECM and the video side by side for WM and OC. The ECM and video results showed relatively similar results for the OC and RC locations.

For OC, mode 9 represented ~80% of the activity. For the RC site modes 6 and 7 represented ~40-50% and 50-60% of the activity, depending on where the video or ECM was used. For the WM site, there are more significant differences between the video and ECM percent times. For the video, mode 1 was found to represent ~70% of the activity, and for the ECM data, mode 2 represented the highest percentage time at 45%. The reason for the difference for WM could be due to issues in sampling for short durations with the real-time tools. The ECM data was captured for fewer days than the video where approximately 53 hours of valid ECM data was captured compared to over 400 hours of video were recorded. According to the WM survey information, pushing trash is the dominate operation at the land fill and is estimated at the 60 to 80% range for the D7E and higher for

the D8R. The other modes were much less significant. See Appendix A for more details. The video and survey information suggests that the ECM fractions do not represent the true operational behavior. This doesn't suggest the ECM data is invalid, but it does suggest that the ECM data at WM do not reflect the overall behavior modes of WM. Thus, the time spent in each mode was weighted more on video records and less on ECM records for the bulldozer.



Figure 4-9 Activity time lapse video from the bulldozer for various operations

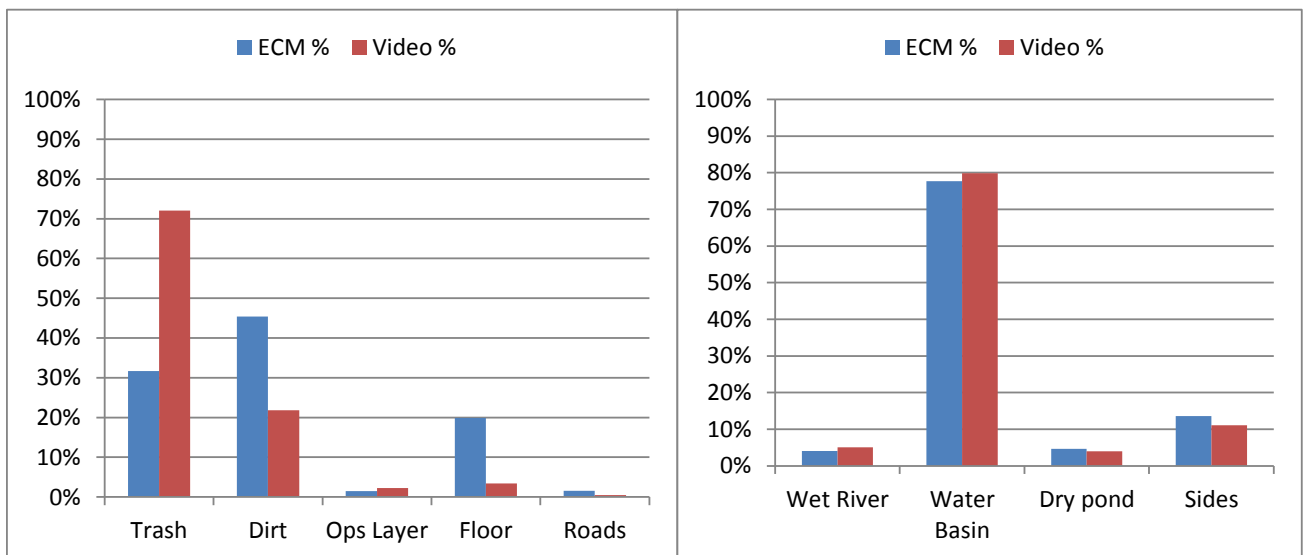


Figure 4-10 Video fractions and ECM fractions by mode for each participant

**Table 4-5 Video and ECM activity mode percent time fractions for the D7E and D8R**

Participant	Equipment	Activity	ECM Hours <sup>1</sup>	ECM %	Video Hours <sup>2</sup>	Video %	
WM	D7E T4i	Trash <sup>1</sup>	1	16.9	31.7%	231	72.0%
WM	D7E T4i	Dirt <sup>1</sup>	2	24.3	45.4%	69.9	21.8%
WM	D7E T4i	Ops Layer <sup>2</sup>	3	0.8	1.5%	7.3	2.3%
WM	D7E T4i	Floor <sup>3</sup>	4	10.6	19.9%	11.0	3.4%
WM	D7E T4i	Roads <sup>2</sup>	5	0.8	1.5%	1.5	0.5%
WM	D8R T3	Trash <sup>1</sup>	1	21.3	100.0%	186	100.0%
OC	D7E T4i	Wet River <sup>1</sup>	8	2.2	4.1%	3.8	5.1%
OC	D7E T4i	Water basin <sup>1</sup>	9	42.5	77.7%	59.1	79.8%
OC	D7E T4i	Dry pond <sup>1</sup>	10	2.5	4.6%	3.0	4.0%
OC	D7E T4i	Sides <sup>2</sup>	11	7.4	13.6%	8.2	11.0%
RC	D7E T4i	Prep <sup>3</sup>	6	15.8	41.4%	42.7	51.8%
RC	D7E T4i	Rocks <sup>1</sup>	7	22.4	58.6%	39.7	48.2%

<sup>1</sup> Pushing trash, fill dirt, dry river dirt and weeds, wet river dirt and weeds, and rocks

<sup>2</sup> Building operational layer, roads, and pond sides

<sup>3</sup> Preparing area for material and building roads for trucks

<sup>4</sup> Cannot be sure of equipment on idle from video

#### 4.1.5 Statistics uni-modal analysis

As discussed earlier each of the events defined in the statistical analysis are based on events or pushes and pulls, of a bulldozer. The pushes and pulls are the primary function of the bulldozer and can vary from a short 1-2 meter push to as large as a few hundred meters. The data presented in this section represents all the valid ECM and GPS data for the D7E and D8R for each of the participants. The data was considered as a whole by participant, by mode, and as a composite from all participants. All the events were pooled into large files with the appropriate flags and processed with a Matlab program. It was quickly noticed that normal averaged results would not work on the event statistics due to the skewed data set. Thus statistical percentiles were used from a Matlab program. The program calculated and reported the 5<sup>th</sup>, 50<sup>th</sup>, and 95<sup>th</sup> percentile statistics. From these statistics the proposed duty cycle was prepared.

Figure 4-11 shows the histogram plots for event distance at WM, OC, and RC and for both the D7E and D8R. All the modes such as trash, dirt, pond and road work are pooled together in these figures. Thus, the figures show the overall statistics. On each figure the 5<sup>th</sup>, 50<sup>th</sup>, and 95<sup>th</sup> percentile data is listed. The D7E range of 50<sup>th</sup> percentile event varies from 20 meters to ~30 meters and the D8R is 33.6 meters. The range in events varied from 5 meters (5<sup>th</sup> percentile WM D7E) to as long as 122 meters (95<sup>th</sup> percentile D7E OC). In all cases the events for each dozer type show relatively similar 5<sup>th</sup>, 50<sup>th</sup>, and 95<sup>th</sup> percentile events.

In discussion with WM Operations and Maintenance the 50<sup>th</sup> percentile event distances are in good agreement with recommended practices to try and minimize push length where a 20-30 meter push is

expected. Thus, it is believed that the data captured represent the true operation of WM landfill and the event identification approach is robust and should capture the true behavior at all facilities.

Figure 4-12 shows the same 50<sup>th</sup> percentile statistics as above, but grouped by composite, mode, facility, and unit ID (D7E versus D8R). The figures show statistics for distance, unit speed (km/hr), engine speed (rpm), and power (hp). The composite events represent all the modes grouped together and are designated by the “\_a”. The individual modes are designated by “\_1”, “\_2”, etc. which represent the operational modes described in Table 4-1 and the fraction of time spent in each mode is listed in Table 4-5. The “All\_a” is the overall composite where all the D7E’s events are grouped for WM, OC, and RC. The “D8a” and “D8b” are the D8R conventional event information.

The range of D7E 50<sup>th</sup> percentile event distances between modes varies from 12 meters to 35 meters, which is more than all the 5<sup>th</sup> and less than all the 95<sup>th</sup> percentile events, but is still a wide range. At WM, trash pushing (mode 1) had the longest push distance and building roads (mode 5) had the shortest distance. According to the video and WM interviews, the bulldozer spends less than 1% of its time in mode 5 and around 70% of its time in mode 1, thus the longer push is more relevant, see Table 4-5. The D7E and D8R both showed about the same 50<sup>th</sup> percentile push distance while in mode 1 at 33 and 34 meters respectively. Note the D8R is only used for trash pushing at WM (based on operations and video documentation) where the D7E is used in modes 1 through 5, but mostly in mode 1, as shown in Table 4-5.

The composite mode, “\_a”, for the D7E at WM is relatively low with a 50<sup>th</sup> percentile distance of 20 meters compared to 33 meters for mode 1. One would expect the composite mode to represent the overall statistic, but due to a lower event count at mode 1 and higher event counts at modes 2 – 5 the statistics are skewed low. The video results show that the ECM logging fraction was weighted more towards modes 2 – 5 and the true weighting should have been for mode 1, see Table 4-5. Thus, the statistically significant metrics will be drawn from mode 1 for WM.

The D7E event distances for OC and RC were relatively similar to mode 1 from WM and ranged from 26 to 35 meters. Video and ECM fractions (see Table 4-5) show that events statistics for OC and RC are consistent and one can draw directly from the statistics as presented.

The 50<sup>th</sup> percentile engine speed for the D7E averaged about 1600 rpm for all modes for WM, OC, and RC except mode 6 at RC. The mode 6 50<sup>th</sup> percentile engine speed was 1250 rpm at RC. Mode 6 is defined as preparing the area which involves light dozing on roads and tight maneuvers that represent slower speeds. See Appendix A for more details on mode descriptions. The D8R also showed lower engine speeds with a 50<sup>th</sup> at around 1400 rpm. The D8R is gear driven and utilizes engine speed to regulate unit velocity where the D7E utilizes constant engine speed and controls velocity with power due to the unique capability of the electric hybrid drive system.

The 50<sup>th</sup> percentile unit speed varied from 5.5 km/hr to 3 km/h for WM and OC respectively. According to Figure 4-6 the actual speed at WM during a typical event varied from around 3 km/hr (during a heavy push) to round 8 km/hr (during a pull). This suggests the speed for the D7E actually should be bi-modal. Similarly the power and fuel consumption showed the same bi-modal behavior as speed where during a push the load and fuel consumption were high (170 hp, 13.5 gal/hr) and during a pull the load and fuel consumption were lower (60 hp, 7 gal/hr). Thus, the 50<sup>th</sup> percentile speed, power and fuel consumption may not be very meaningful metrics.



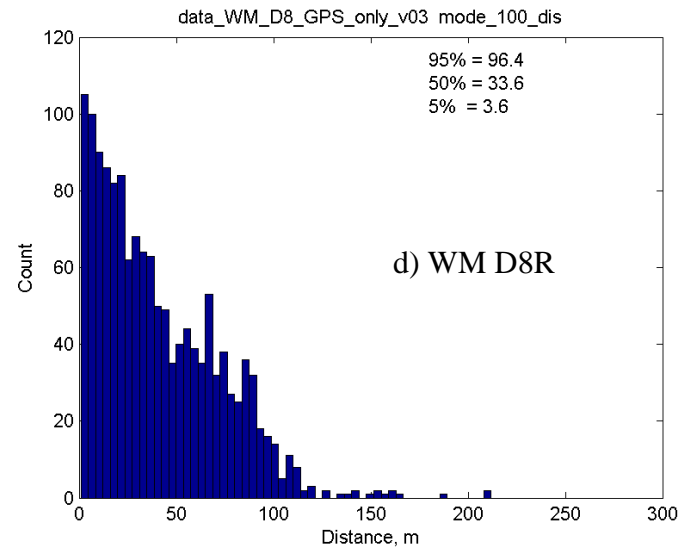
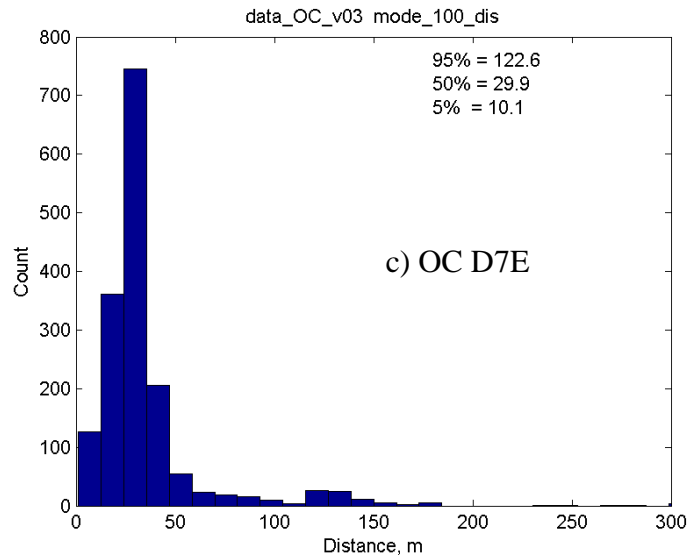
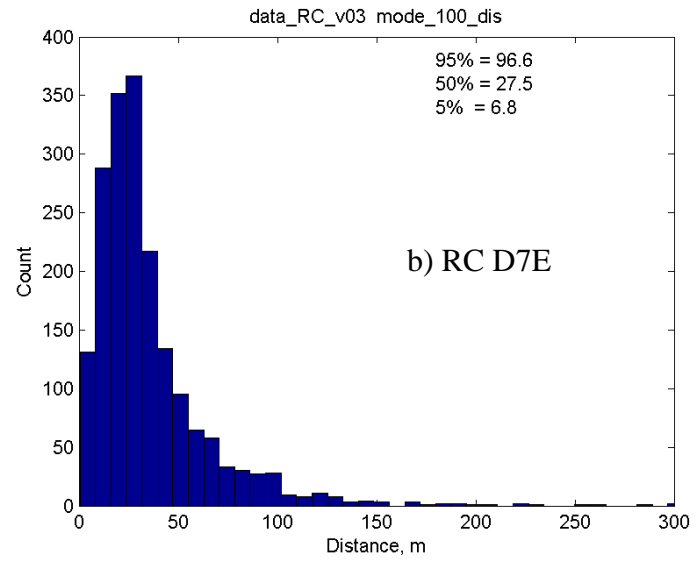
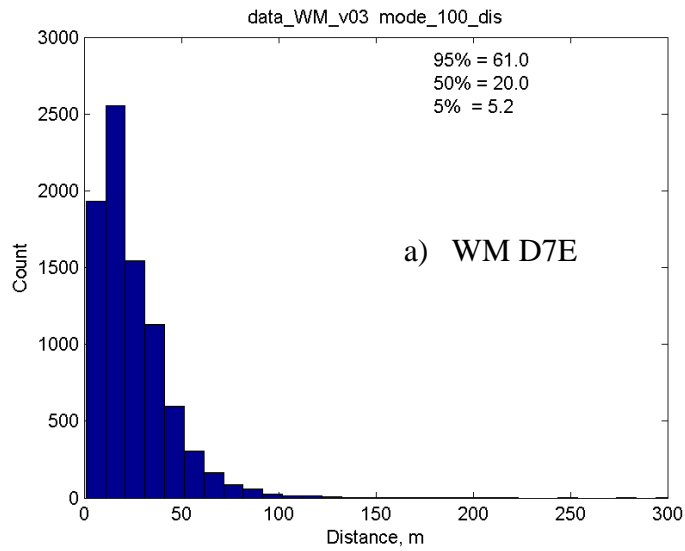


Figure 4-11 Histogram plots for the D7E at WM (a), RC (b), OC (c) and the D8R WM (d)

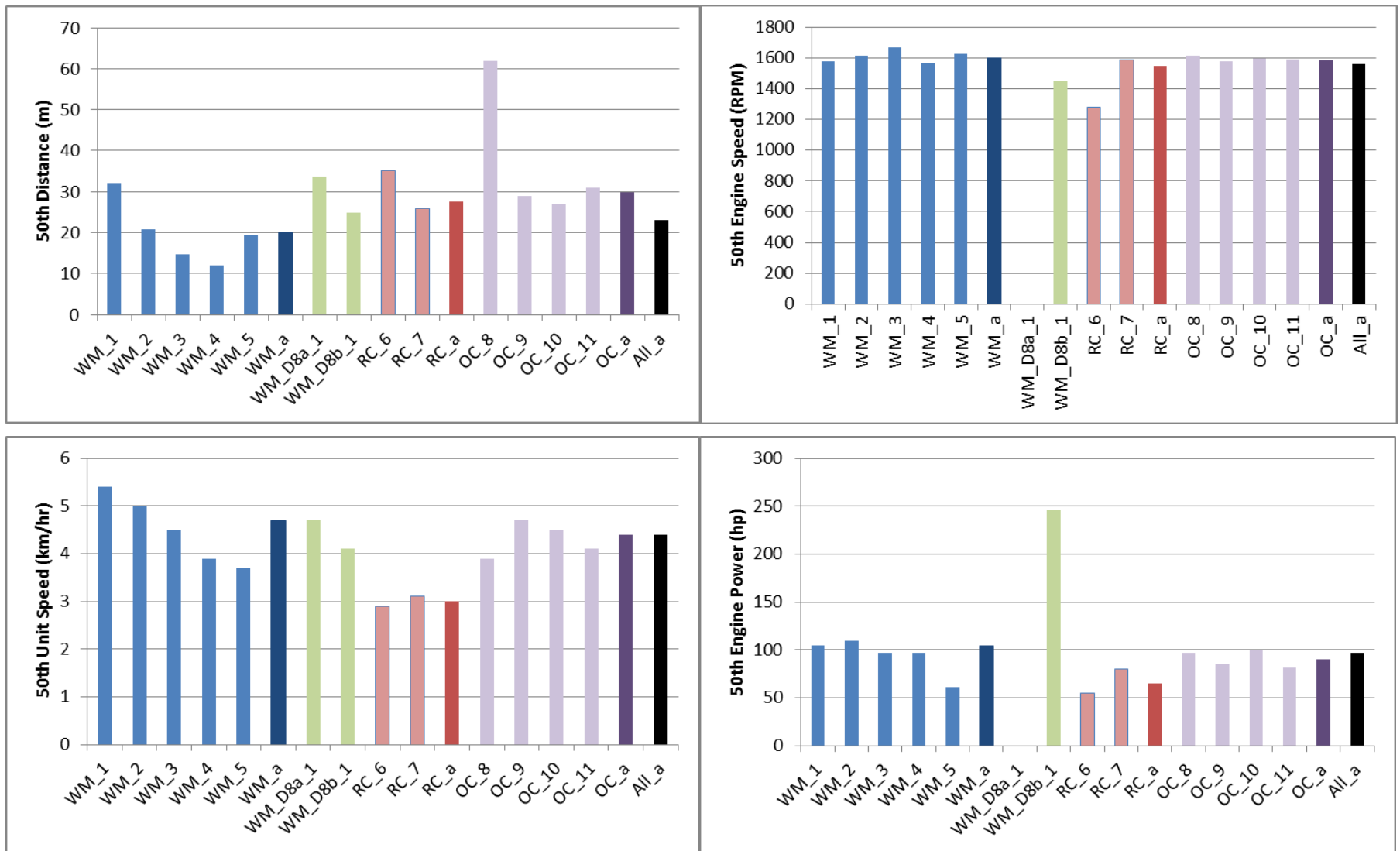


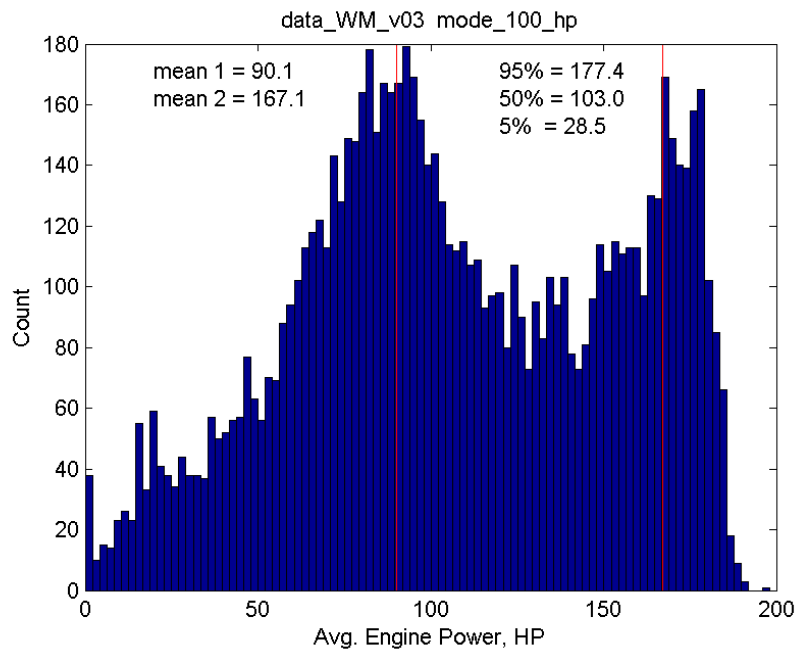
Figure 4-12 50<sup>th</sup> percentile statistics for valid events by mode for the D7E and D8R <sup>1</sup>

<sup>1</sup> Power is calculated from a nominal lug curve and broadcast ECM % load. WM\_D8a\_1 utilized UniCAN accurate speed GPS and WM\_D8b\_1 utilized CAT ET and a GPS which showed poor speed averaging. “\_1” represents mode 1, see Table 4-1 for details, “\_a” is a composite of all events by that facility, and “ALL\_a” is a composite of the D7E for all facilities and all modes.

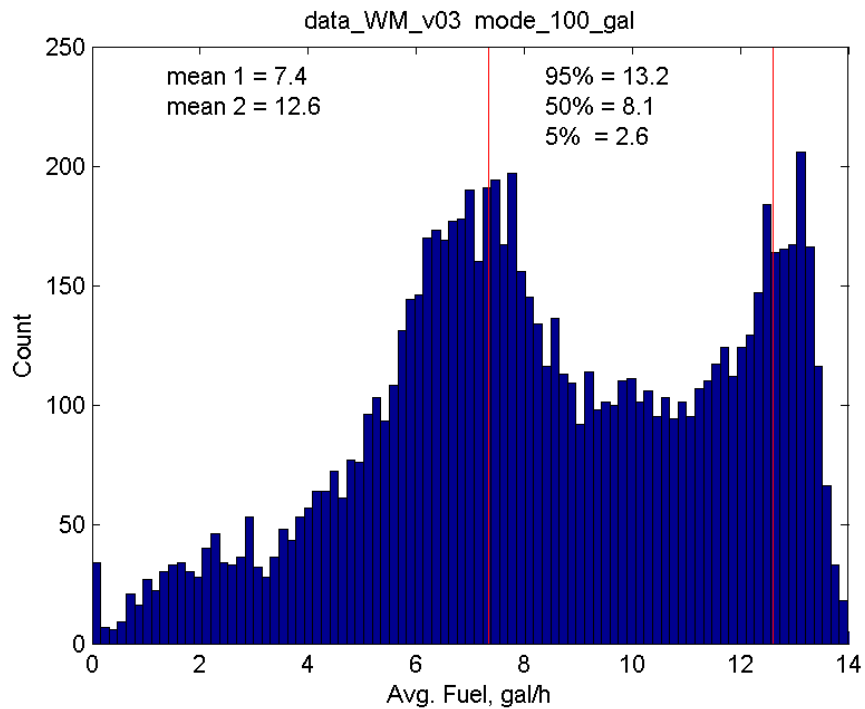
#### 4.1.6 Statistics bi-modal analysis

The engine power, fuel rate, and unit speed data were reprocessed to investigate the statistical means of a bi-modal distribution. Matlab has a function that uses a Gaussian mixture distribution. This function provides the means for multi-component distributions. It was used to determine the mean peaks for power, fuel rate, and unit speed. Figure 4-13 through Figure 4-15 show the bi-modal means for WM's D7E for all modes combined. The "mean 1" represents the first peak and "mean 2" represents the second peak. For power, mean 1 was at 90 hp and mean 2 was at 167 hp. These two means are very close to the real time trend of 60 hp and 170 hp for pulls and pushes described earlier (see Figure 4-5 and Figure 4-6). The same trend was found for fuel consumption where mean 1 was 7.4 gal/hr and mean 2 was 12.6 gal/hr which agree well with the data in Figure 4-5 and in Figure 4-6. Unit speed, however, did not show a bi-modal distribution mean and Matlab did not identify separate means 1 or 2 (see Figure 4-15).

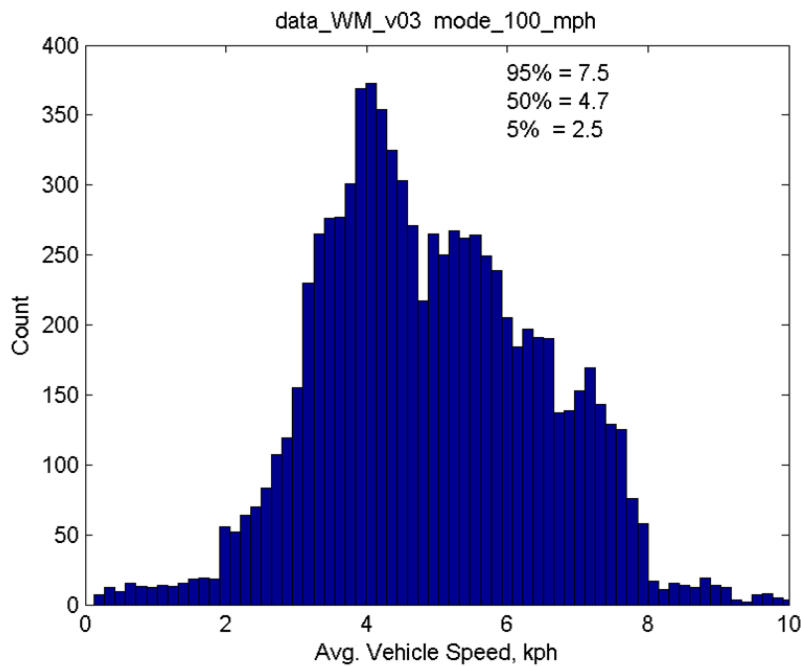
Speed did not show a bi-modal distribution from the event statics as seen in Figure 4-15 even though Figure 4-6 shows two distinct unit speeds from 3 to 8 km/hr. Some reasons speed may not have shown a bi-modal distribution could be due to the small range of speeds, operator behavior, and the difficulty for maintaining traction. In general, the bi-modal nature of the events suggests power and fuel rate targets should be closer to the bi-modal means and unit speed should be closer to that presented in Figure 4-6 for the D7E and in Figure 4-8 for the D8R.



**Figure 4-13 Bi-modal mean histogram for power at WM all modes combined**



**Figure 4-14 Bi-modal mean histogram for fuel consumption at WM all modes combined**

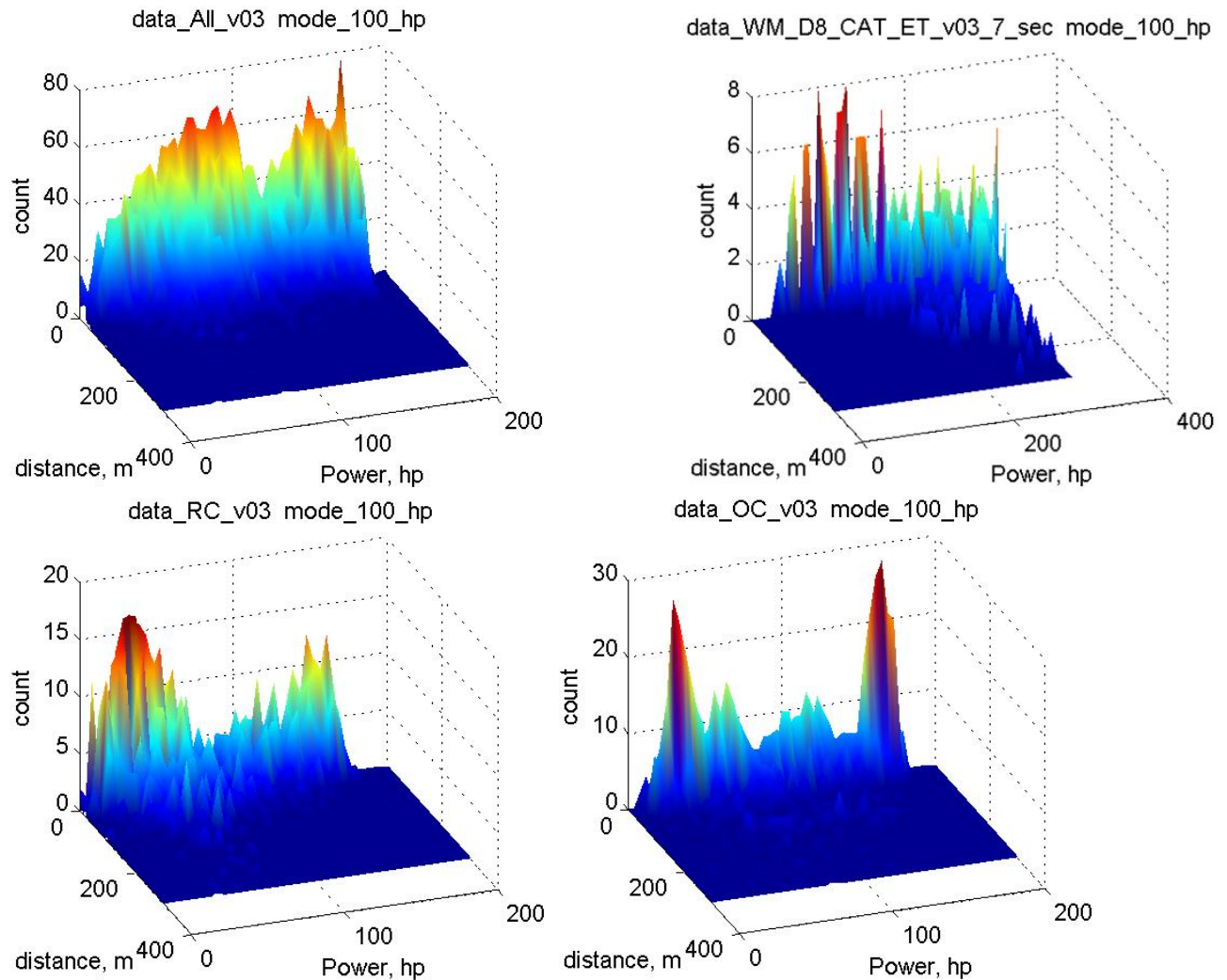


**Figure 4-15 Bi-modal mean histogram for unit speed (km/hr) at WM all modes combined**

#### 4.1.7 Contour plots

Figure 4-16 shows contour plots for the D7E and D8R bulldozers at WM, OC, and RC facilities. The plots show power on the y-axis, distance on the x-axis, and event count on the vertical z-axis. The D7E plot has a strong bi-modal distribution at the 50<sup>th</sup> percentile event distance. These figures confirm that the D7E event distance metric is relevant and truly captures the behavior of the bulldozer at WM, OC and RC facilities. The D8R plot does not show a clear bi-modal distribution and this is also suggested by the real time figure where load, speed, and fuel consumption are

relatively high in the pull direction, see Figure 4-7 and Figure 4-8. More contour and histogram plots are provided in Appendix A.



**Figure 4-16 Contour plots for distance, power, and frequency for all bulldozers**

#### 4.1.8 Bulldozer results summary

In summary, the statistics show that the bulldozer event distance and power vary by operational mode and by fleet facility. In this subsection the results are summarized and condensed into final statistics selected for the proposed duty cycles.

Table 4-6 shows the 10<sup>th</sup>, 50<sup>th</sup>, and 90<sup>th</sup> push distances with operational mode and weighting fraction. The weighting fraction comes from Table 4-5 presented previously. WM shows predominantly short 50<sup>th</sup> percentile events for modes 1 – 5 where mode 1 is the longest at 32 meters. Mode 1 also represents the bulk of their operation. RC shows event distances from 37 to 26 which represent ½ their operation at each mode. OC shows a 29 meter event distance for the dominant operating mode. Thus, a 50<sup>th</sup> percentile event distance of 30 meters appears to represent all the facilities.

The 10<sup>th</sup> percentile event appears to be close for all facilities at around 10 meters, but the 90<sup>th</sup> is broad. The 90<sup>th</sup> percentile event distance ranges from 60 at WM to 120 meters at OC. The large tails to long distances on the 90<sup>th</sup> percentile (see Figure 4-11) are skewing the data to the results to the right where the real 90<sup>th</sup> percentile may be closer to 60 meters. As such, UCR recommends a 90<sup>th</sup> percentile event closer to 60 meters and suggests 80 meters for the 90<sup>th</sup> percentile event.

There is a significant difference in load between WM and RC/OC. WM tends to load the bulldozer more heavily compared to RC and OC. Table 4-7 shows a list of 10<sup>th</sup>, 50<sup>th</sup>, and 90<sup>th</sup> event summary statistics for power weighted by operational mode and use fraction. Figure 4-17 and Figure 4-18 show a comparison of 10<sup>th</sup>, 50<sup>th</sup>, and 90<sup>th</sup> event statistics for each of the facilities dominant power and distance operational modes, respectively. WM shows more power at the 10, 30, and 60 meter trips compared to OC and RC. The additional power is on the order of 50 hp, or twice as much for the 30 meter push compared to RC. This suggests the type of pushes (heavy versus light) vary between facilities also. This makes sense given WM's business is to move as much material as fast as possible where at OC and RC they are trying to accomplish a specific task that requires moving only so much material under controlled conditions. As such, a special cycle is proposed that considers light pushing. It is suggested to do a light push event at the 50<sup>th</sup> percentile distance of 30 meters.

**Table 4-6 Distance event summary statistics weighted by operational mode**

Facility	Mode	Distance			Use
		10 <sup>th</sup>	50 <sup>th</sup>	90 <sup>th</sup>	Fraction
WM	1	8.8	32.2	61.7	72.0%
WM	2	8.7	20.9	45.7	21.8%
WM	3	7.2	14.7	21.0	2.3%
WM	4	5.9	12.1	32.9	3.4%
WM	5	7.3	19.4	40.1	0.5%
RC	6	11.5	37.8	106.0	51.8%
RC	7	11.0	26.0	55.4	48.2%
OC	8	8.3	29.0	138.8	5.1%
OC	9	13.1	29.1	124.4	79.8%
OC	10	12.9	27.0	48.8	4.0%
OC	11	17.5	30.9	37.6	11.0%

**Table 4-7 Power event summary statistics weighted by operational mode**

Facility	Mode	Power			Use
		10 <sup>th</sup>	50 <sup>th</sup>	90 <sup>th</sup>	Fraction
WM	1	64.9	104.5	172.6	72.0%
WM	2	56.8	109.5	173.6	21.8%
WM	3	10.0	91.2	170.6	2.3%
WM	4	31.0	97.4	166.2	3.4%
WM	5	42.6	61.0	88.7	0.5%
RC	6	30.5	52.6	88.5	51.8%
RC	7	21.9	78.1	151.5	48.2%
OC	8	42.4	85.2	144.4	5.1%
OC	9	46.5	83.5	135.3	79.8%
OC	10	67.5	100.0	137.1	4.0%
OC	11	24.6	81.0	168.0	11.0%

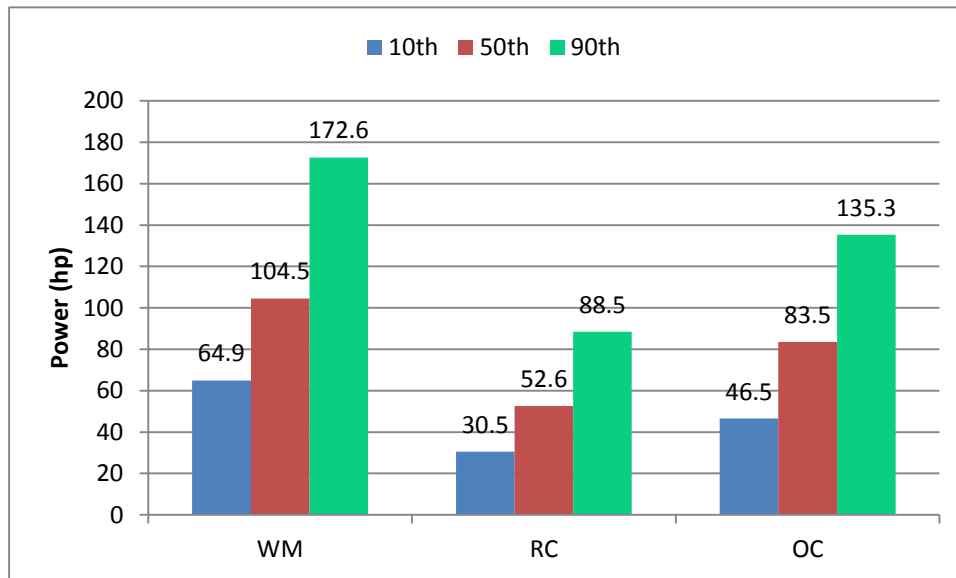


Figure 4-17 Power event comparison for largest operational mode

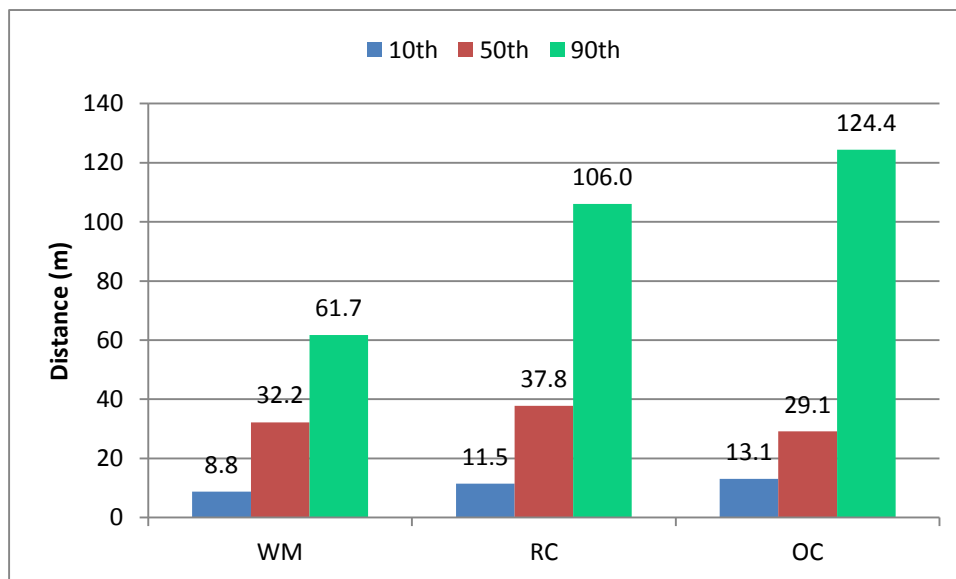


Figure 4-18 Distance event comparison for largest operational mode

## 4.2 Komatsu excavators

The Komatsu excavator measurements were made at Road Machinery (RM), Claremont Equipment Rental (CE), and Diamond D Engineering (DD) between February 27 and March 21, 2013. RM and CE represent rental operations and DD is a general engineering firm. All three represent private fleet operations and are not part of a public fleet.

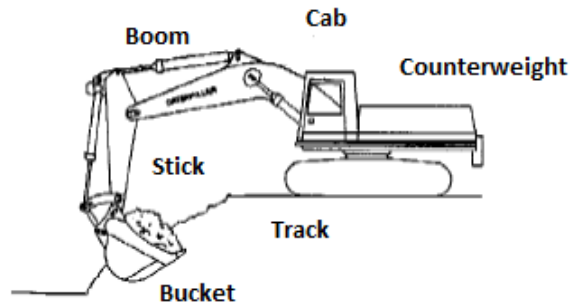
### 4.2.1 Interview data

#### *Diamond D (DD) physical activity*

For Diamond D the excavator is a multi-purpose tool for general work with underground utilities and for finer work in landscaping and cleaning ditches. The major modes of operation in general construction are trenching with 45° swings, setting pipe, backfilling and compacting with a compacting wheel and ditch cleaning with 90° swings. They estimate that trenching/digging constitutes 50% of their work, compacting is 20%, ditch cleaning is 20%, and other underground utility work is 10%.

DD also indicated that operator technique and excavator options can play a significant role in how efficiently the excavator is used (i.e., the amount of fuel required to get a specific job done). By describing the general configuration of an excavator, they showed the major influences of design and how those can interact with operator technique to influence work efficiency. We summarize what we learned here.

Apart from engine size, the main parts of the excavator that influence work effort are the track, the boom, the stick, and the bucket. These parts of an excavator are indicated in the graphic in Figure 4-19. According to DD, the length of the boom and stick and the size of the bucket are all important to specify when comparing excavators. For example, an excavator with longer boom and stick and larger bucket will require more power to operate than one with smaller parts.



**Figure 4-19 Main parts of an excavator**

The excavator operator is also a very important influence on equipment efficiency. The operator interacts with the excavator parts (via controls in the cab) to perform work. If one thinks of the boom/stick/bucket assembly as similar to a human arm, it is intuitive how the operator can maximize efficiency by how he uses them. For example, it is easier and more efficient to lift a weight and hold it in front of you if your arms are slightly bent than if they are fully extended. The same applies to an excavator. In fact, the graphic in Figure 4-19 also shows the position of maximum power and efficiency for digging. When the bucket is full, the boom is approximately horizontal, the stick has reached the vertical (i.e., perpendicular to the boom), and the bucket lever is approximately perpendicular to the stick. In these positions, the levers upon which the hydraulic rams operate are at their points of maximum leverage. Therefore, for a given engine output, the excavator can exert the most force on the material being worked.

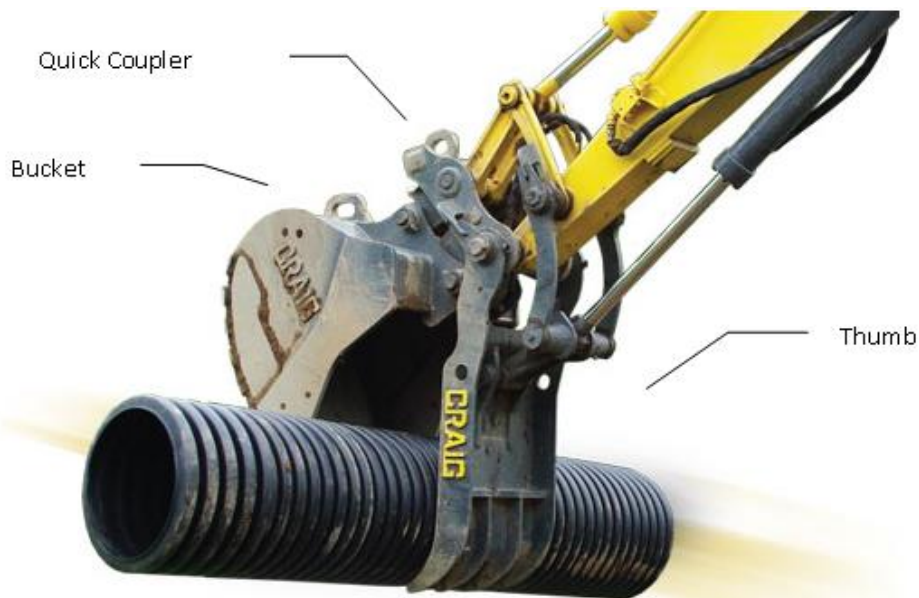
The position of the boom/stick/bucket assembly is also important when the excavator is rotating from one position to another, and back again (this action is called “swing”). During the swing of the excavator, the operator should hold the bucket close to the cab. When the bucket is far from the cab, more power is required to accelerate and decelerate the swing. This effect can be easily understood by standing with your arms extended straight out from your sides and swinging your body back and forth while holding your feet still, then by bringing your arms down to your sides and doing the same motion. It is far easier to swing with your arms down than with them extended.

There is even a proper orientation for the tracks that good operators will usually make sure they use. The gear that drives the track (called the sprocket) should be to the rear, under the counterweight. This is because the track idler, on the other end, touches the ground farther from the mid-point of the track, giving the excavator a slightly longer reach before tipping. This gives the operator more time in a given position before having to move (which is a non-productive activity).

The attachments used by the excavator and how they are connected to the stick, should also be the same when comparing different units. Excavators of this size use various attachments to extend their utility. For example, most of these types of excavators have an attachment called a “thumb,” which



allows the bucket to be used as the fingers of a hand with an opposable thumb (for grasping loose materials). Also, these types of excavators also frequently have a “quick coupler” on the end of the stick to allow the changing of bucket sizes and other attachments (like a compactor wheel) to be done quickly and without outside help.



**Figure 4-20 Excavator with "thumb" and "quick coupler" attachments**

#### *Diamond D seasonal effects*

Being located in northern California, DD equipment is used more frequently in the summer when rain is not an issue. The summer work is mostly in general construction and small utilities, but also cleaning ditches when available. The excavators are used less during the winter, mainly for cleaning ditches in agricultural work.

#### *Claremont Equipment Rental (CE) physical activity*

Claremont Equipment Rental is the sales and rental agency and does not actually use the excavator. The construction company who used the CE equipment studied in this project rented a few machines to support a large housing project near Escondido, CA. A majority of the time the excavator was doing demolition work where the excavator grabs debris from a pile, breaks walls and roofs, dresses the fallen building material, and loads the materials into trucks and hoppers.

The same operator operated the same machine for the majority of the time. There were no attachment changes and the operator used the thumb more often than the other two participants.

#### *Claremont Equipment seasonal effects*

Claremont rents their machinery almost exclusively in southern California. Its excavators in this size range are used mainly in the residential and light commercial construction industries. So the main seasonal effects on usage patterns are occasional rains in the winter. However, these are infrequent enough that the practical impact on average usage is minimal.

#### *Road Machinery (RM) physical activity*

Road Machinery is also an equipment rental agency that does not directly use the excavator. For the duration of this study, Bali Construction rented the RM excavator. It was used for installing

underground utilities on the site of a new hospital being built near Lancaster, CA. The work involved digging trenches, placing various types of pipes and so on.

#### *Road Machinery (RM) seasonal effects*

Road Machinery is also a rental company, but their rental territory covers the entire state of California. Like those of CE, its excavators in this size range are used mainly in the residential and light commercial construction industries. So in southern California the main seasonal effects on usage patterns are occasional rains in the winter. However, these are infrequent enough that the practical impact on average usage is minimal. In northern California, the seasonal effects are more pronounced and similar to those of DD equipment. That is in the winter, seasonal rains slow the rental rate for construction and the excavators tend to be used for schedule insensitive work, such as ditch cleaning and private property maintenance (ditch cleaning, etc.) during opportunities between rains.

#### *4.2.2 Development of Event Data*

Similarly to the bulldozer cycle development, the development of the excavator duty cycle requires defining events, behaviors, or a combination of both. Excavators of this size are used for many more types of work than bulldozers, and these types of work are generally not identifiable in the ECM/GPS data. Thus, the video data play a much larger role for excavator duty cycle development. Excavator videos were reviewed frame by frame so that work modes and the date/time could be assigned when the excavators were active. Video frame rates were typically once every 5 seconds, so the time resolution of activity assignments was also every 5 seconds. When an excavator was seen to have stopped operation, the “stop” mode was later parsed into either “off,” “stop low idle” or “stop high idle” based upon the corresponding ECM data. Table 4-8 shows the modes as defined after post-processing the time-aligned data along with a brief explanation of what each mode represents. Some of the mode numbers are not whole numbers because they were added after the first iteration of modes were named. The initial mode assignments were determined from the time lapse video. Figure 4-24 shows an example of various modes of operation for the excavator.

For additional input into mode development, an excavator test cycle developed by Komatsu was reviewed. This cycle is discussed in Section 5.2.3 of this report. The Komatsu cycle shows what the manufacturer considers to be important features of the various modes of operation for the purposes of emissions testing the hybrid excavator. Since Caterpillar is also developing a hydraulic hybrid excavator that assists during the swing operation, the features of the Komatsu developed cycle are likely to be important to Caterpillar as well. Prominent modes Komatsu included in their cycle are several digging modes with various ranges of swing (45°, 90°, and 180°). They also included a “dirt leveling” mode (what is called “dress” in this report), an extended idle mode and a mode they called “traveling” (what is called “move” in our activity data). So, although some of the digging modes of the Komatsu cycle were not observed in the video data, they have been included in the list of modes because they are almost certainly widely used in the industry. Some of these (e.g., digging with a 180 degree swing) were probably not observed during the project due to the limited range of types of excavator projects that were sampled.

**Table 4-8 Mode identification for excavators**

Name	Filter No. <sup>1</sup>	Work Mode Description
stop rpm low	0	Stop doing what was being done and be still for 30 (or so) seconds or more with idle low. Idle determined during post processing.
stop rpm high	0.5	Stop doing what was being done and be still for 30 (or so) seconds or more with idle high. Idle determined during post processing. Could be still but using PTO.
btrench	1	Trench or dig with bucket facing backward (toward operator) with big bucket and 45 ° swings.
strench	2	Trench or dig with bucket facing backward (toward operator) with small bucket. 45 ° swing.
Bscoop	3	Trench or dig with bucket facing forward (away from operator) with big bucket. All swings.
Sscoop	4	Trench or dig with bucket facing forward (away from operator) with small bucket. All swings.
Dig	4.5	Dig with 180° swings.
bbackfill	5	Move loose dirt back into a hole or trench with big bucket and 45 ° swings.
Bditch	5.5	Dig over the side track with bucket facing backward (toward operator) with big bucket and 90 ° swings.
sbackfill	6	Move loose dirt back into a hole or trench with small bucket. 45 ° swing.
Sditch	6.5	Dig over the side track with bucket facing backward (toward operator) with small bucket and 90 ° swings.
compact	7	Use compacting wheel attachment to compact dirt.
Crane	8	Move objects. Hold them in the air. Hold or push them down. Usually without attachment but sometimes with.
Dress	9	Scrape, break-up packed surface with teeth, move loose dirt, smooth the surface. Light demolition (wall, fence), move loose material, clear debris. Up to 45 ° swings.
maneuver	10	Short moves. Change attachments. Reposition at same work location.
Move	11	Move on tracks longer than 30 (or so) seconds. Change work locations.
Carry	12	Carry items, debris, etc. to pile, hopper
Grab	13	Grab items, debris and put them somewhere nearby. 90 to 180 ° swings.
Unk	14	Unknown activity due to obscured camera view (rain, bucket low, etc.)

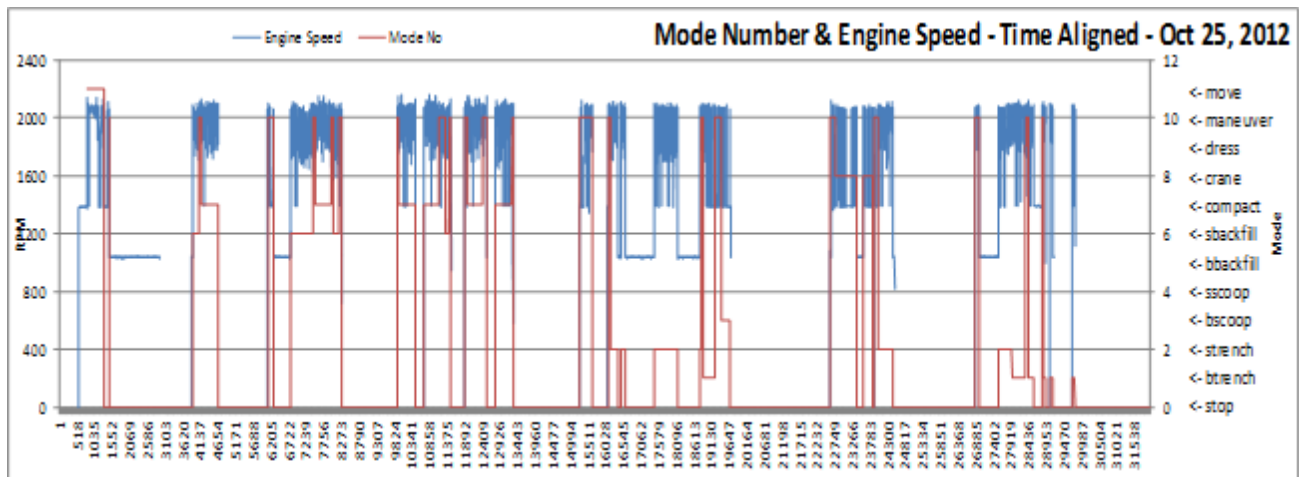
<sup>1</sup> Filter ID Number is based on the filter code added to the data files and is not the duty cycle mode number

#### 4.2.3 Video mode determination

Time lapse video was critical for the determination for the excavator’s operational modes. The video equipment was installed on each excavator for between 3 and 10 calendar weeks. Since these excavators were not used at night, video was recorded from before sunrise until a few hours after sunset at a rate of one frame every 5 seconds. The cameras and data were checked periodically during the recording period for quality assurance. Due largely to the experience gained from bulldozer activity logging, no data loss was experienced during the excavator activity data collection. Figure 4-24 shows an example of various modes of operation for the excavator.

Video for each day of activity were reviewed to identify whether any activity occurred and the time when the activity began and stopped. For each period of activity or mode, the type of activity was identified. For a typical day, the first mode of the day was often “move” with the excavator positioning itself to begin work at a certain location. Then often the excavator stopped and waited for the conditions to begin work to occur. This served as a marker both for when the “move” ended and the “stop” began. Later the excavator began some type of work activity and the date and time of the new activity was noted, and so on. For each day a spreadsheet with three columns (date, time and mode) was developed. The plot in Figure 4-21 shows a graph of the modal data for a conventional excavator being used at Fort Hunter Liggett construction site. The various modes (red line) are represented by their mode number on the secondary “Y” axis and labels to the right side of the

graph. The engine RPM is on the primary (left) axis. On this day the excavator was used in a wide variety of modes, mainly: backfill, compact and trench.



**Figure 4-21 Excavator video modal data plot (17 Dec 2012)**

As discussed previously, several modes were identified as part of the event determination process (see Table 4-8). Several of these modes showed similar ECM power and engine speed and were thus, grouped to a smaller set of unique events. Operational modes such as dressing, grabbing and carrying objects are very similar equipment usages as will be shown. Additionally some back filling operations are similar to trenching, but others are not. We discuss this in more detail in the discussion below on the reduction analysis approach. Table 4-9 shows a list of the final modes used in the remaining analysis. The modes were reduced from 19 to 6, plus two idle modes. The modes grouped are carry, grab, and dress; s-trench and b-backfill; crane and maneuver; compact and s-backfill; travel, and b-trench. A small amount of idle is integrated into each of the modes since it is an unavoidable part of many of the construction modes and is not distinguishable from some non-idle events in the ECU data (e.g. craning). Additional analysis was performed on more extended idles that could be identified using the previously discussed combination of video and ECU data analysis to characterize the time spent at low and high-idle for extended periods. This is described in more detail in section 4.2.4 below.

**Table 4-9 Video and ECM activity mode percent time fractions for the HB215 and PC200**

Participant	Equipment	Activity <sup>4</sup>	ECM Hours <sup>1</sup>	ECM % <sup>3</sup>	Video Hours <sup>2</sup>	Video %
Diamond D	HB215 T3	carry,grab,dress	0.1	0.2%	0.1	0.2%
Diamond D	HB215 T3	strench, bbackfill	16.2	49.3%	17.2	44.4%
Diamond D	HB215 T3	crane, maneuver, bscoop	3.4	10.4%	6.6	17.0%
Diamond D	HB215 T3	compact, sbackfill	8.1	24.6%	8.9	22.9%
Diamond D	HB215 T3	move, travel	2.3	7.1%	3.0	7.7%
Diamond D	HB215 T3	btrench	2.8	8.4%	3.1	7.9%
Diamond D Hybrid Total <sup>3</sup>			32.8	100.0%	38.8	100.0%
Diamond D	PC200 T3	carry,grab,dress	1.6	6.2%	1.7	4.9%
Diamond D	PC200 T3	strench, bbackfill	8.2	31.4%	9.8	28.3%
Diamond D	PC200 T3	crane, maneuver, bscoop	4.3	16.4%	9.0	26.0%
Diamond D	PC200 T3	compact, sbackfill	5.1	19.7%	6.7	19.5%
Diamond D	PC200 T3	move, travel	1.7	6.5%	2.2	6.3%
Diamond D	PC200 T3	btrench	5.2	19.8%	5.2	15.1%
Diamond D Conventional Total <sup>3</sup>			26.1	100.0%	34.6	100.0%
Escondido	HB215 T3	carry,grab,dress	45.8	82.9%	tbd	tbd
Escondido	HB215 T3	strench, bbackfill	0.0	0.0%	tbd	tbd
Escondido	HB215 T3	crane, maneuver, bscoop	5.0	9.1%	tbd	tbd
Escondido	HB215 T3	compact, sbackfill	0.0	0.0%	tbd	tbd
Escondido	HB215 T3	move, travel	4.5	8.1%	tbd	tbd
Escondido	HB215 T3	btrench	0.0	0.0%	tbd	tbd
Escondido (Clairemont Equipment) Hybrid Total <sup>3</sup>			55.3	100.0%	tbd	100.0%
Lancaster	HB215 T3	carry,grab,dress	0.4	4.2%	2.4	10.4%
Lancaster	HB215 T3	strench, bbackfill	5.5	62.8%	7.9	34.4%
Lancaster	HB215 T3	crane, maneuver, bscoop	1.6	17.7%	9.4	41.0%
Lancaster	HB215 T3	compact, sbackfill	0.0	0.0%	0.1	0.6%
Lancaster	HB215 T3	move, travel	1.3	15.3%	3.1	13.6%
Lancaster	HB215 T3	btrench	0.0	0.0%	0.0	0.0%
Lancaster (Road Machinery) Hybrid Total <sup>3</sup>			8.8	100.0%	23.0	100.0%

<sup>1</sup> ECM activity hours obtain from filtered data

<sup>2</sup> ECM and video total hours obtained from total filtered data, excludes stops mode

<sup>3</sup> Percentage based on filtered data which exclude stop and other modes

<sup>4</sup> Activity is only moving activity, does not include equipment idle/stops

#### 4.2.4 ECM and GPS

Over 160 hours of ECM and GPS data have been collected for the hybrid HB215LC-1 and conventional PC200 excavators. Due to the nature of excavators, the GPS data was not used for event determination in this analysis. The events were solely based on video observation. Once the modes of work were tabulated in a spreadsheet for a given date and time, these data were aligned with the ECM using a cross-correlation function in MATLAB<sup>®</sup>. Once the modal and ECM data are aligned, statistical and graphical analyses are used to determine which modes stand out in the data and which are probably most important in terms of emissions and fuel consumption. Table 4-10 shows the hours of activity logging for the ECM and video systems for the units tested. The ECM hours range from 15 hours to 71 hours and the video ranges from 270 hours to over 800 hours. ECM hours include actual key on event. Video hours are usually recorded from 6am to 6pm daily including excavator non-activity and weekends.

Several issues were identified in the real time ECM data that required data reduction in order to perform the duty cycle analysis. For event accuracy, short events that last less than 30 seconds in duration were filtered out. Bulldozer operations included events less than 30 seconds, but the types of modes with the excavator were much longer, where 30 second events and shorter were statistically not valid. Each event was trimmed 5 seconds from the beginning and the end to compensate for errors in event identification and video to ECM alignment. The amount of data loss from time alignment filtering was less than 1% of the total data. High engine idle was not filtered out and is part of each of the operational modes. But long low engine idle was removed from the events listed in Table 4-9.

Figure 4-22 shows a list of the total data records collected and the amount of filtering for each test site. On average, 10% of the total raw input ECM data was filtered out. In the end, all three of the participants were fairly even with approximately 120,000 rows of data for each fleet. We performed statistical analysis on about 130,000 seconds of data for Diamond D's HB215LC-1, about 110,000 seconds of data for Diamond D's PC200, and about 120,000 seconds of data for Claremont Equipment's HB215LC-1.

**Table 4-10 Summary of total ECM and video collected from each participant**

<b>Excavator Participant</b>	<b>Unit Tested</b>	<b>Location</b>	<b>ECM Hours</b>	<b>Video Hours</b>
DD	HB215	Ft. Hunter Liggett, CA	43.9	280
DD	PC200	Ft. Hunter Liggett, CA	35.3	276
CE	HB215	Escondido, CA	70.8	840
RM	HB215	Lancaster, CA	14.6	708
<b>Excavator Total</b>	n/a	n/a	164.6	2104

The hybrid excavator showed 44% of its activity performing trench and backfill operations at one location and carry, grab, and dress at another location (see Table 4-9). The conventional excavator showed the highest fraction of usage in the same trench and backfill operations at 26%. This suggests the type of work was similar between the hybrid and conventional operation at this facility. As such, additional analysis in the next section will include comparing the hybrid and conventional for this facility to investigate possible operational difference between the technologies.

**Table 4-11 Date record collected from each participant for HB215 and PC200**

Data ID	event < 30 secs	event trimmed	engine speed < 1050 <sup>2</sup>	gross	net	% filt
Diamond D Hybrid	862	1440	20841	153202	130059	15.1%
Diamond D Conventional	556	2030	4942	121307	113779	6.2%
Escondido Hybrid <sup>1</sup>	1459	3070	5414	131202	121259	7.6%
Combined <sup>3</sup>	2877	6540	31197	405711	365097	10.0%

<sup>1</sup> Data analysis based on data up to 2012.12.29

<sup>2</sup> All low idle data removed except stop mode, see idle table for details

<sup>3</sup> Part Escondido and Lancaster data excluded

Similar to the bulldozer analysis, most idle mode was considered separately from the combined data set to characterize idle time. Since there is no simple metric to identify idle modes from the ECM vehicle speed data, a combination of video activity mode and condition where the engine was operating at idle speeds for over 5 seconds was identified as an idle event. So unless the idle mode could be confirmed using video data, they were left as part of the surrounding mode and not separated out as an idle event. The idle speed for the conventional and hybrid are significantly different, as suggested by the manufacturer’s literature. The hybrid’s low-idle is 700 rpm and the conventional low-idle is around 1000 rpm. Table 4-12 shows the percent of time the excavators idled for both high and low-idle. The idle time ranged from 27% for Diamond D’s conventional (construction work) to 8.1% of Escondido’s hybrid (demolition work).

**Table 4-12 Excavator idle time measured during activity assessment**

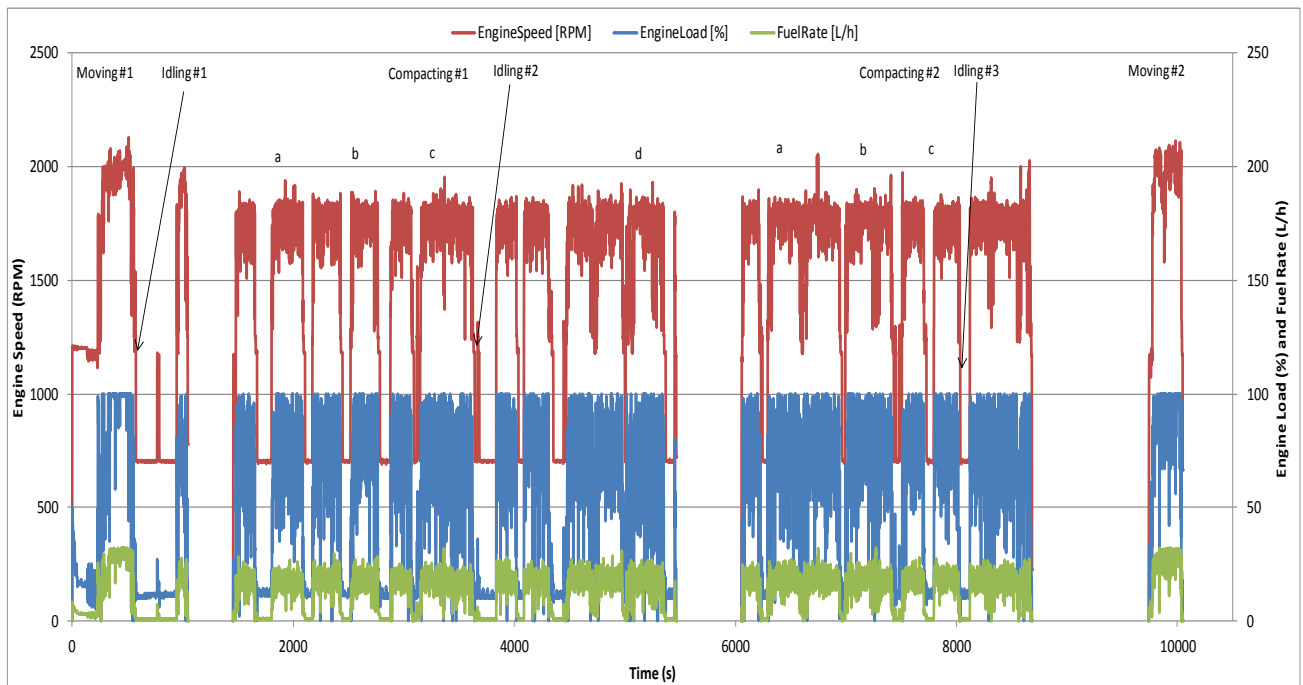
Description	Diamond D Hybrid <sup>2</sup>		Diamond D Conventional <sup>3</sup>		Clairemont E. Hybrid <sup>1</sup>		Road M Hybrid <sup>1</sup>	
	hr	%	hr	%	hr	%	hr	%
<b>total idle</b>	9.2	28.1%	9.2	35.1%	4.7	8.4%	2.2	24.5%
<b>low idle</b>	8.5	26.0%	6.7	25.5%	4.1	7.5%	2.0	22.3%
<b>high idle</b>	0.7	2.1%	2.5	9.6%	0.5	0.9%	0.2	2.2%
<b>total time</b>	32.8		26.1		55.3		8.8	

<sup>1</sup> Escondido hybrid unit

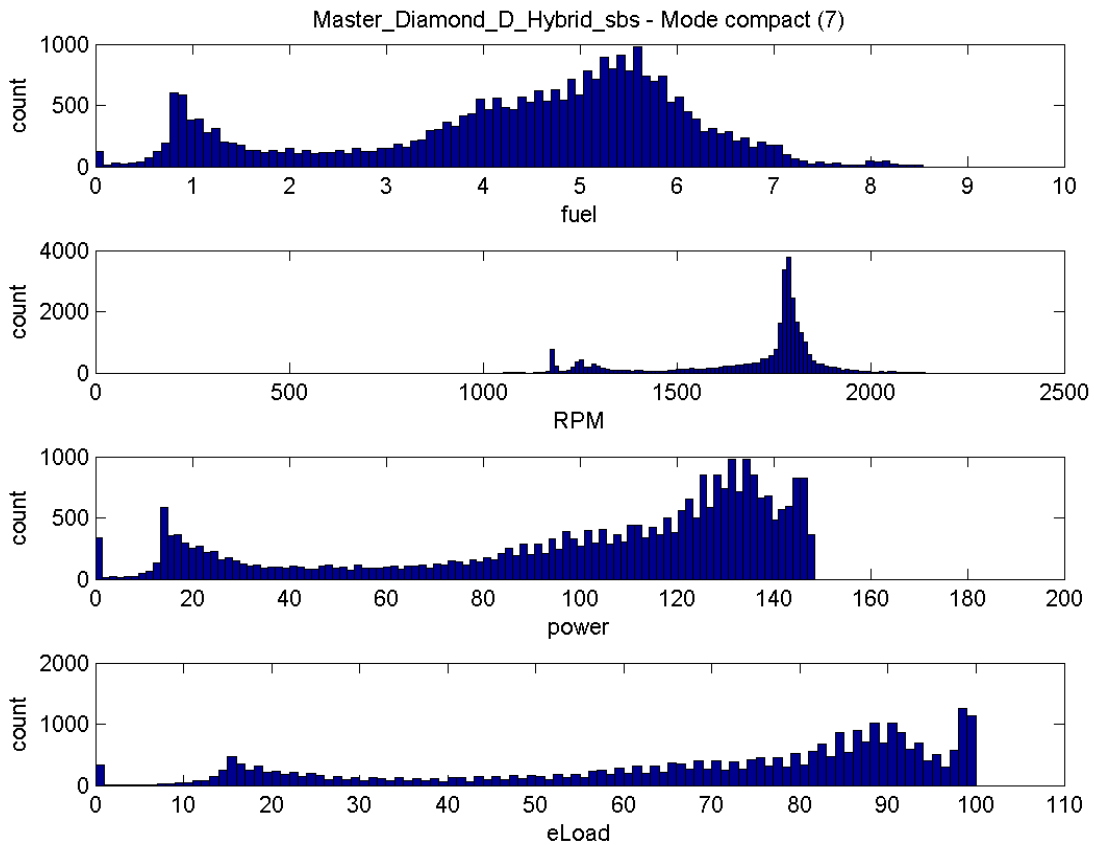
<sup>2</sup> Hybrid low idle = 680~720 rpm, high idle = 1150~1175 rpm

<sup>3</sup> Conventional low idle = 1000~1050 rpm, high idle = 1350~1400 rpm

The plots in Figure 4-22 show typical loads on the excavator engine during construction at the Ft. Hunter Liggett site. It shows engine speed, percent load, and fuel consumption for a period of moving followed by extended dirt compacting and then moving again. This plot shows how the loads can vary significantly during a single mode event (in this case “compacting”).



**Figure 4-22 Typical hybrid excavator engine loads at Ft. Hunter Liggett**



**Figure 4-23 Diamond D hybrid compacting second by second ECM data distribution**

#### 4.2.5 Mode reduction

Due to the high number of different operating modes identified (see Table 4-8) some type of mode reduction was needed in order to propose a reasonable test duty cycle. A duty cycle with 15 modes is



not practical and may over emphasize unique operations of low importance. Thus, prior to analyzing the overall statistics, mode reduction was performed for similar ECM power and engine speed behaviors. The purpose was to identify common modes of engine behavior associated with unique activity modes utilizing the ECM data. The idea is if the engine experiences similar power, fuel use and engine speed between unique activities these modes can be combined. Ideally one would want to reduce the number of modes to about seven (similar to the bulldozer modes).

During initial analysis, over 15 modes were identified for the excavator, as listed in Table 4-8. Several of these modes were found to have similar power and engine speed profiles, suggesting the work performed was not unique, but common between modes. An analysis of variance (ANOVA) using “Sysstat” was performed on the 50<sup>th</sup> percentile distributions to assist in determining significant differences between modes. Due to the combined nature of engine power, engine speed, and distribution shape for each of the modes, additional visual analysis was performed to support the ANOVA analysis.

Figure 4-24 shows an example of the time lapse video taken for the excavator. Figure 4-27 through Figure 4-34 show the engine power and engine speed visual comparisons for the modes that were found to have similar load profiles. Figure 4-27 and Figure 4-28 show the engine speed and power for the carry, grab and dress modes were very similar. The trend for high frequency at low power and at high power is similar for each of the modes, see Figure 4-27. Also the engine speed shows a unique bi-modal trend where there is significant frequency of occurrence at low rpm and high rpm (see Figure 4-28). The ANOVA analysis also suggested these modes for 50<sup>th</sup> percentile engine speed, power, and fuel rate are not statistically different thus, justifying grouping these data into a single mode.

Similarly the modes s-trench and b-backfill were grouped together as shown in Figure 4-29 and Figure 4-30. The ANOVA analysis agreed well for this grouping as well. The modes crane and maneuver are shown in Figure 4-31 and Figure 4-32 where there is good visual agreement. The ANOVA analysis did consider these data as statistically different suggesting they should not be grouped. The reason is due to the difference in 50<sup>th</sup> percentile statistics. It is visually reasonable though that the engine power and engine speed suggest these modes are very similar and could be grouped without significantly diluting the uniqueness of the combined modes in the overall test cycle. (The 50<sup>th</sup> percentile data is not necessarily a good metric when there is a strong bi-modal distribution.) The last grouping is for the compact and s-backfill data as shown in Figure 4-33 and Figure 4-34.

The travel, b-trench, and b-scoop data were unique and were thus not combined. This can be seen from Figure 4-35 and Figure 4-36. The ANOVA analysis agreed and showed that these data were unique and that they should not be combined.

In summary the modes grouped are carry, grab, and dress; s-trench and b-backfill; crane and maneuver; compact and s-backfill; travel, and b-trench.



**Figure 4-24 Activity time lapse video from the excavator for various operations**

#### 4.2.6 Hybrid versus conventional

During the analysis it was found that the hybrid and conventional activity for the Ft Hunter Liggett facility showed similar overall statistics (see Table 4-9). This section investigates the comparison between the hybrid and conventional excavators for the Ft Hunter Liggett facility

Figure 4-37 and Figure 4-38 show the engine power, speed, and percent load for the hybrid and conventional excavators. The figures and the ANOVA analysis suggest the two models are statistically different for the move/travel mode. The other modes did not show a significant difference and are thus, not shown. The move/travel mode represents the excavator moving or traveling from point A to point B for an extended period of time. It is surprising that there would be a significant difference with this mode of operation. As such it is recommended that the travel mode be considered as part of the duty cycle to consider the performance benefit with this mode.

#### 4.2.7 Other sources of information

A standard source of information to help understand the use of construction machinery is a series of handbooks published by Caterpillar called the “Caterpillar Performance Handbook”. It provides a summary reference for the construction industry on various types of off-road equipment, their specifications, and general recommendations for how best to use them. To gain additional insight into the main issues to consider in a fair comparison of excavators, the 31st edition of the handbook was referenced and the relevant materials are summarized here.

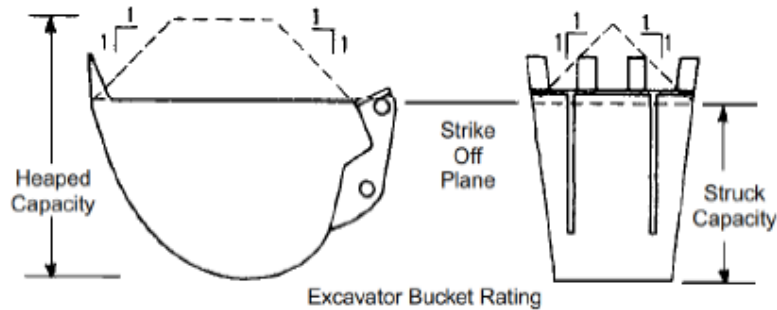
#### *Maximizing production with an excavator*

**Work Zone and Swing Angle** – On page 4-149 the Caterpillar Performance Handbook recommends that for maximum production the swing angle should be limited to 15° on either side of the centerline of the machine (or the width of the tracks). For example, during trenching, the loose dirt should be piled as close to the side of the trench as is safely possible.

Distance from Edge – The stick should be reaching vertical when the bucket is reaching full load. The operator should begin “boom-up” 75% through the curl cycle, which should also be as the stick reaches vertical.

*Bucket Capacity*

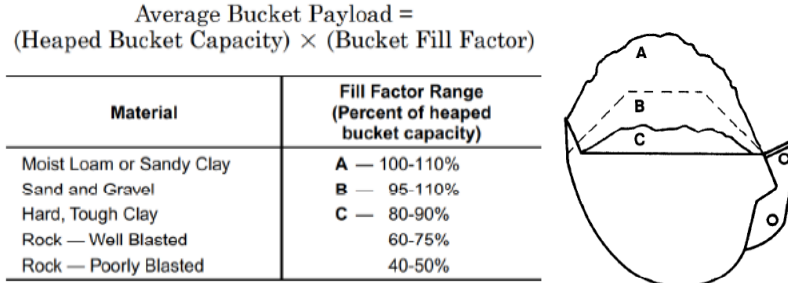
For the purposes of defining different buckets, the “struck capacity” and the “heaped capacity” are defined on page 4-90 of the Caterpillar Performance Handbook. The graphic from their handbook showing these definitions is copied in Figure 4-25.



**Figure 4-25 Bucket capacity definitions from the (Caterpillar Performance Handbook)**

*Bucket Payload*

It is helpful to understand how materials properties will influence the amount of material a bucket can carry (i.e., its payload). Page 4-120 of the Caterpillar Performance Handbook specifies these influences and a table of properties and an accompanying graphic are copied from that page of the handbook for reference below.



**Figure 4-26 Influence of materials on bucket payload <sup>3</sup>**

4.2.8 *Statistics uni-modal analysis*

This section describes the overall statistical analysis of the combined modes as described above. The analysis includes the 5<sup>th</sup>, 50<sup>th</sup> and 95<sup>th</sup> percentile for engine speed, power, fuel rate, and percent load. Figure 4-39 shows each of these metrics as a function of mode. Mode 4 (compaction and s-backfill) shows the largest 5<sup>th</sup> and 50<sup>th</sup> percentile fuel rate, engine power, and percent load. Mode 5 (move/travel) showed the largest 95<sup>th</sup> percentile power, but Mode 4 showed the highest fuel rate. Mode 5 and 6 (travel and b-trench) showed the highest 50<sup>th</sup> percentile engine speed. Mode 3 (crane, maneuver, and b-scoop) showed the lowest 50<sup>th</sup> percentile power, fuel rate, and percent load.

<sup>3</sup> Caterpillar Performance Handbook, 31<sup>st</sup> edition.

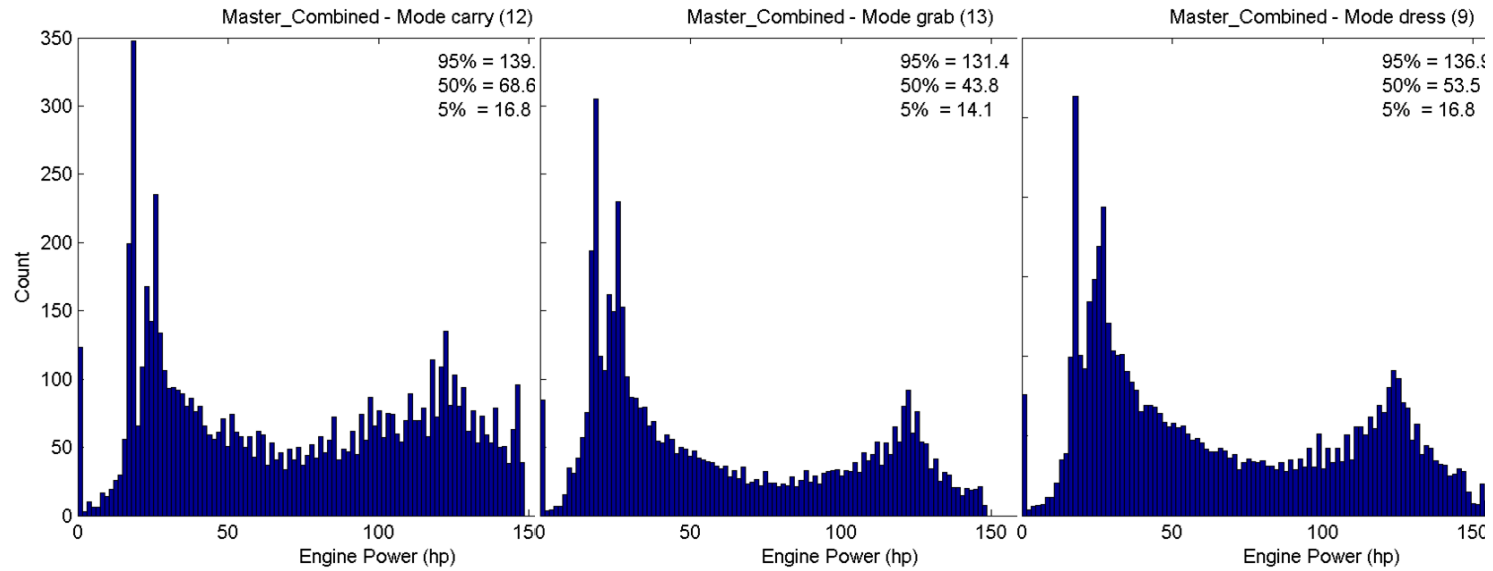


Figure 4-27 Engine power for carry, grab, and dress modes

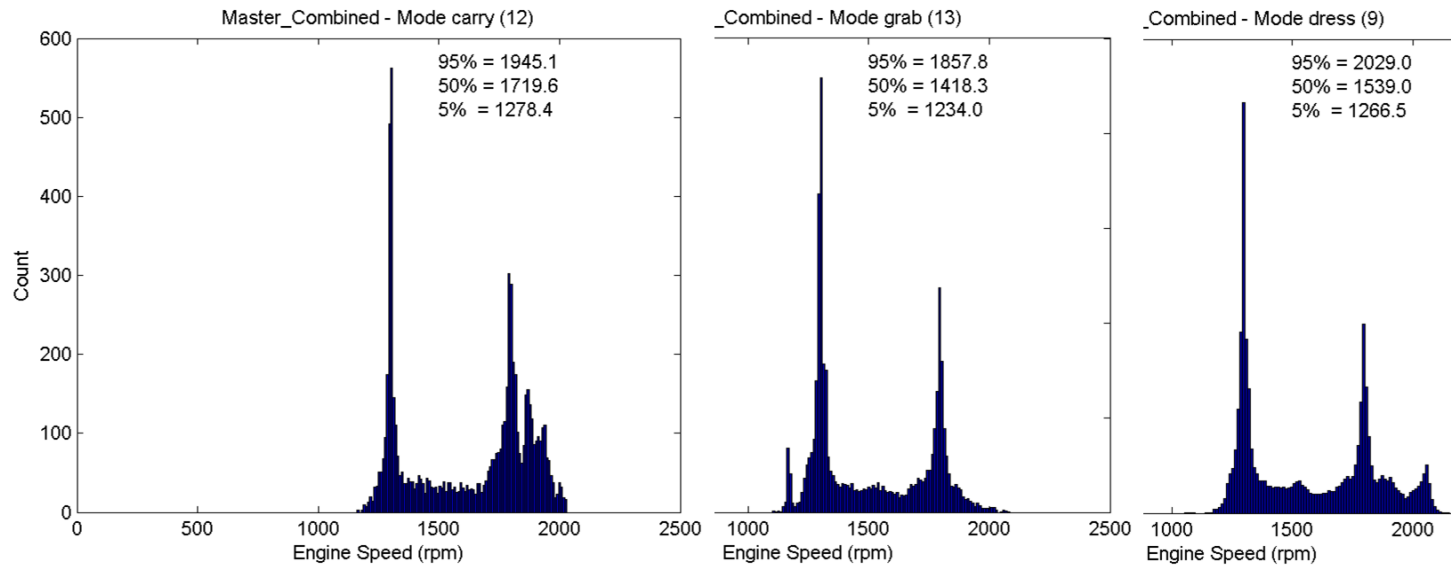
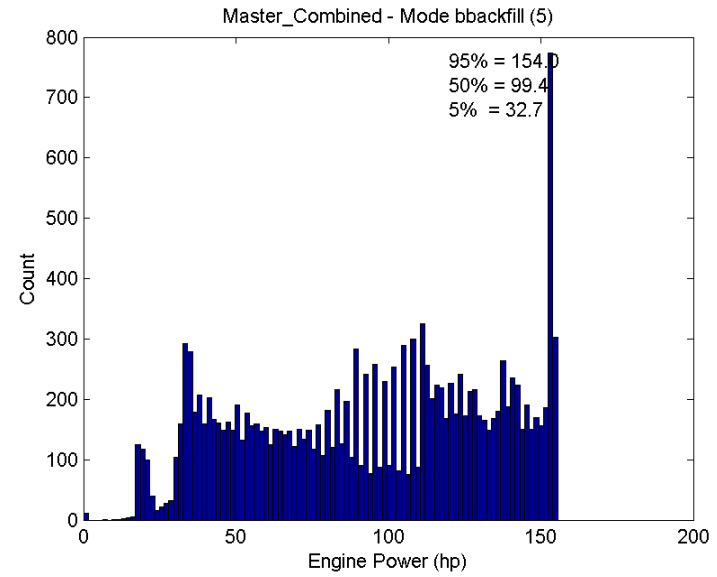
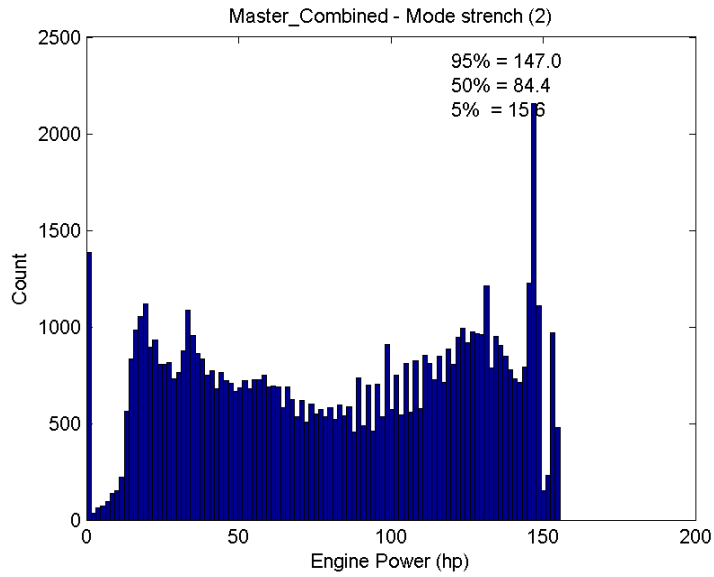
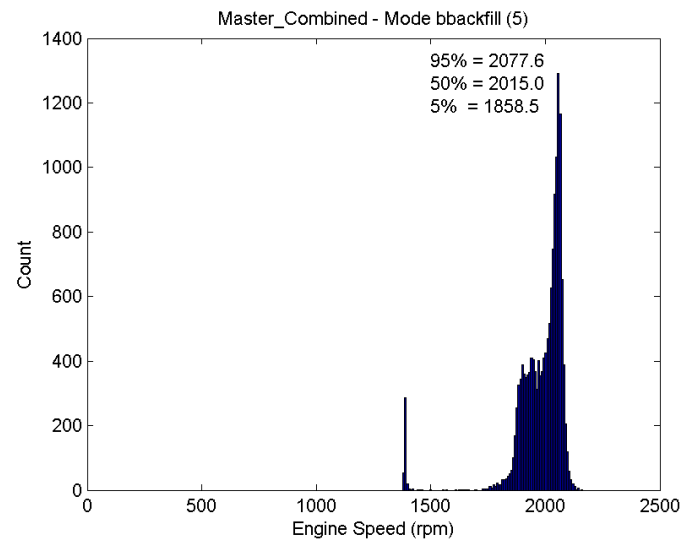
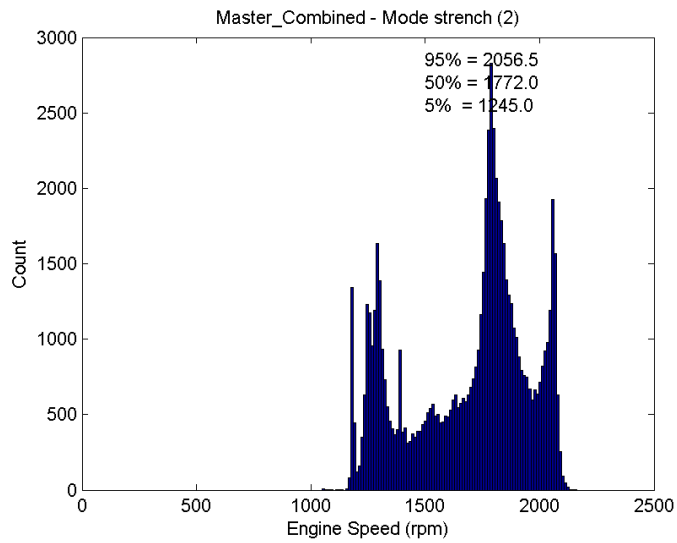


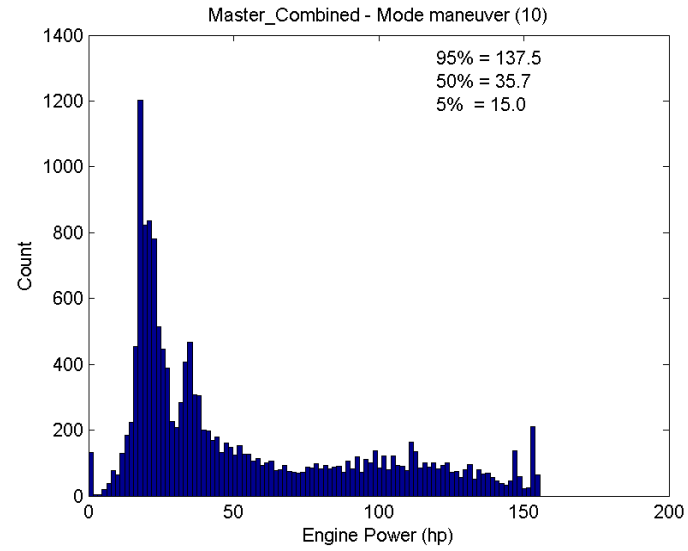
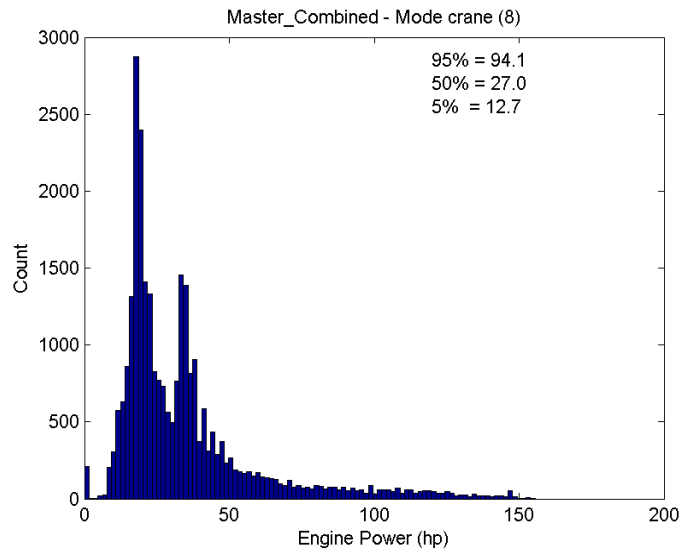
Figure 4-28 Engine speed for carry, grab, and dress modes



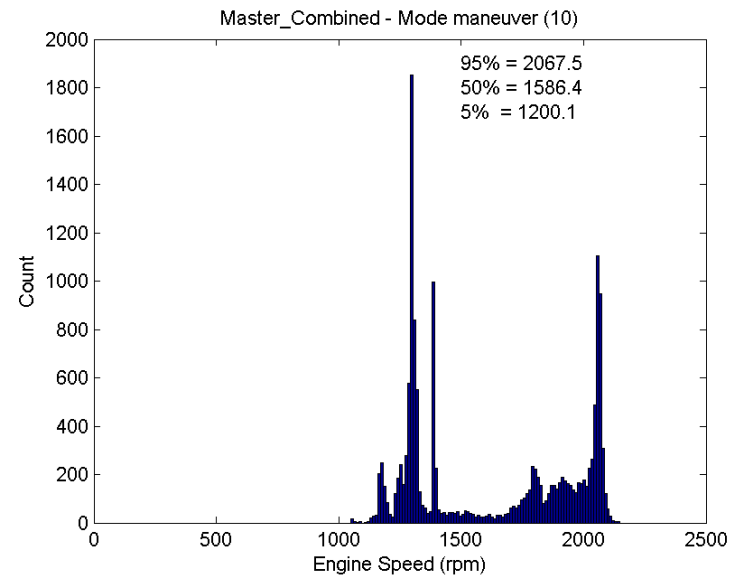
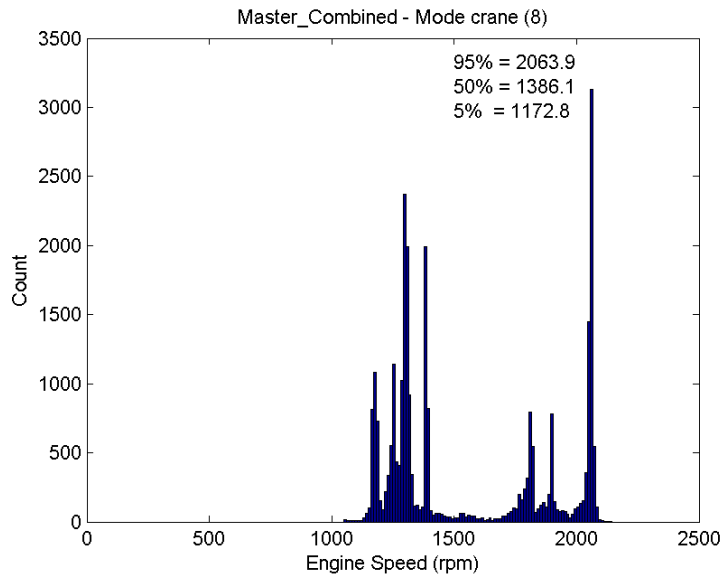
**Figure 4-29 Engine power for s-trench and b-backfill modes**



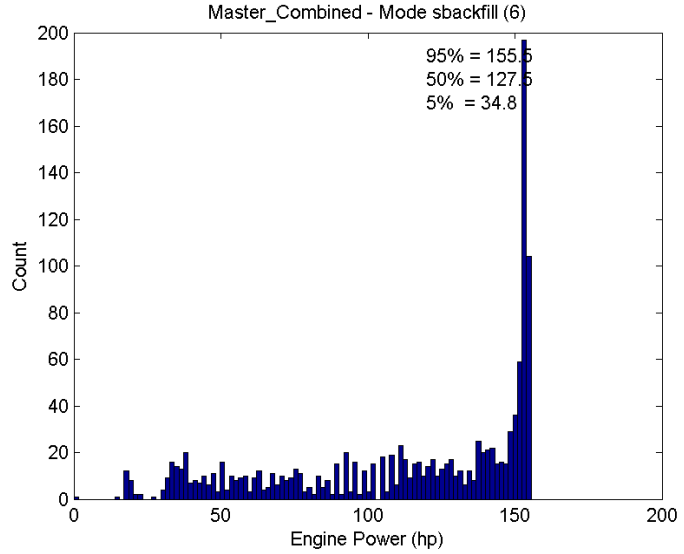
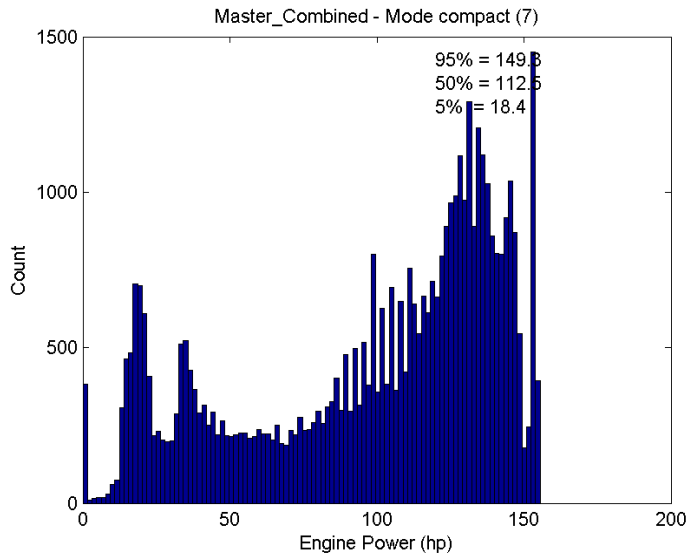
**Figure 4-30 Engine speed for s-trench and b-backfill modes**



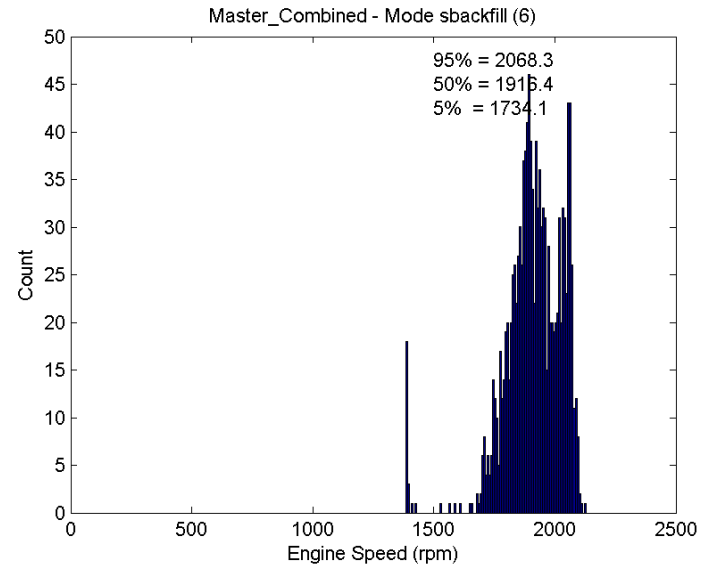
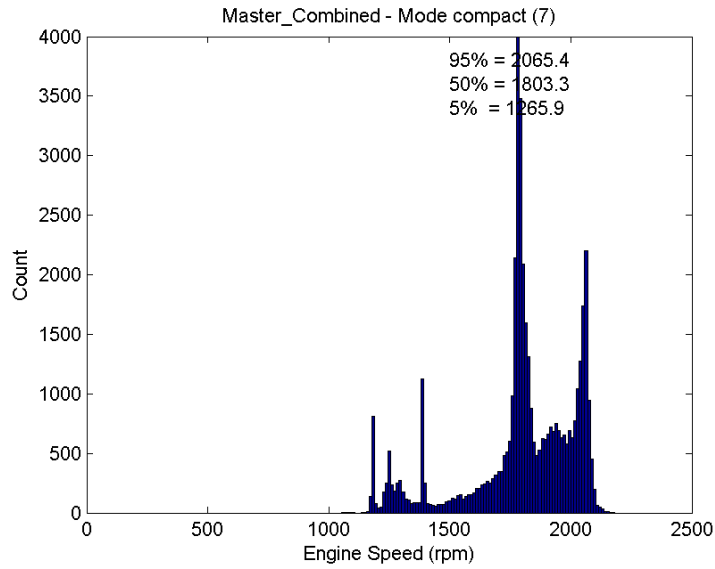
**Figure 4-31 Engine power for crane and maneuver modes**



**Figure 4-32 Engine speed for crane and maneuver modes**



**Figure 4-33 Engine power for compact and s-backfill modes**



**Figure 4-34 Engine speed for compact and s-backfill modes**

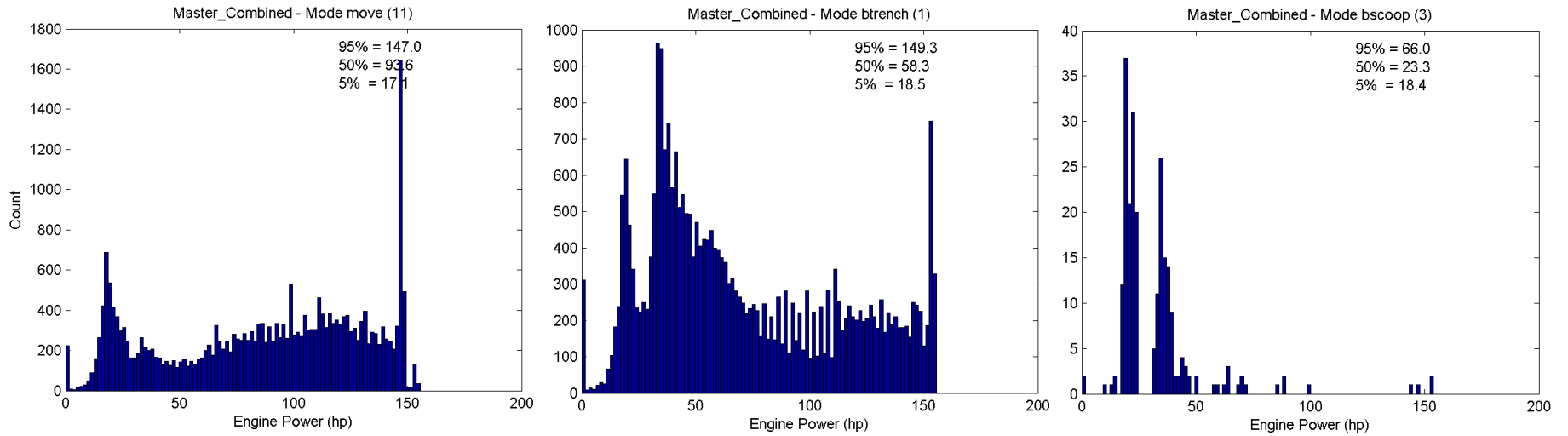


Figure 4-35 Engine power for move/travel, b-trench, and b-scoop modes

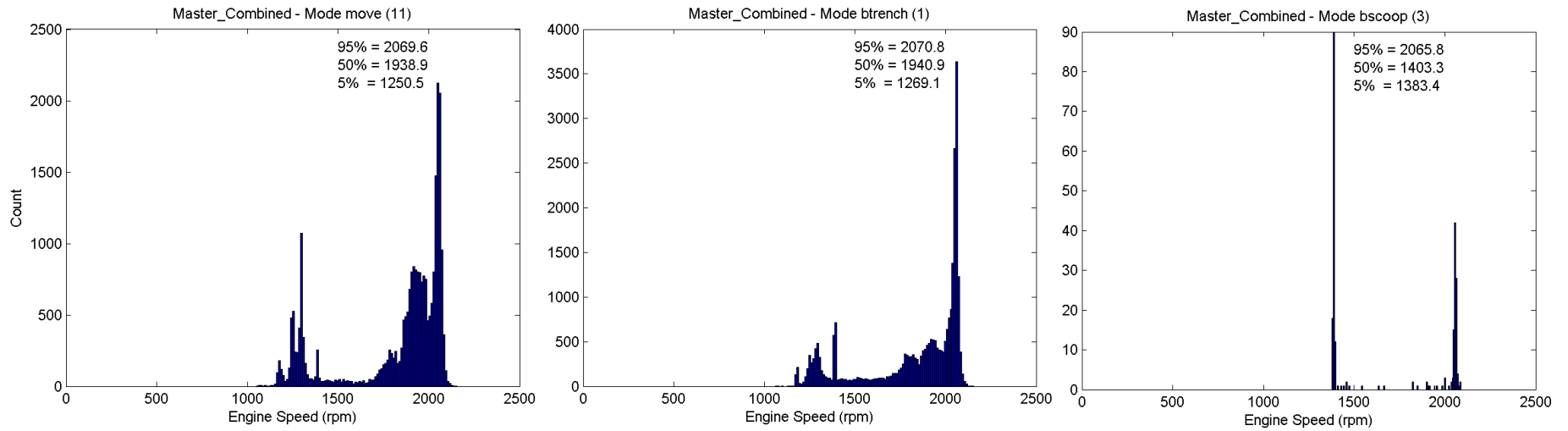


Figure 4-36 Engine speed for move/travel, b-trench, and b-scoop modes



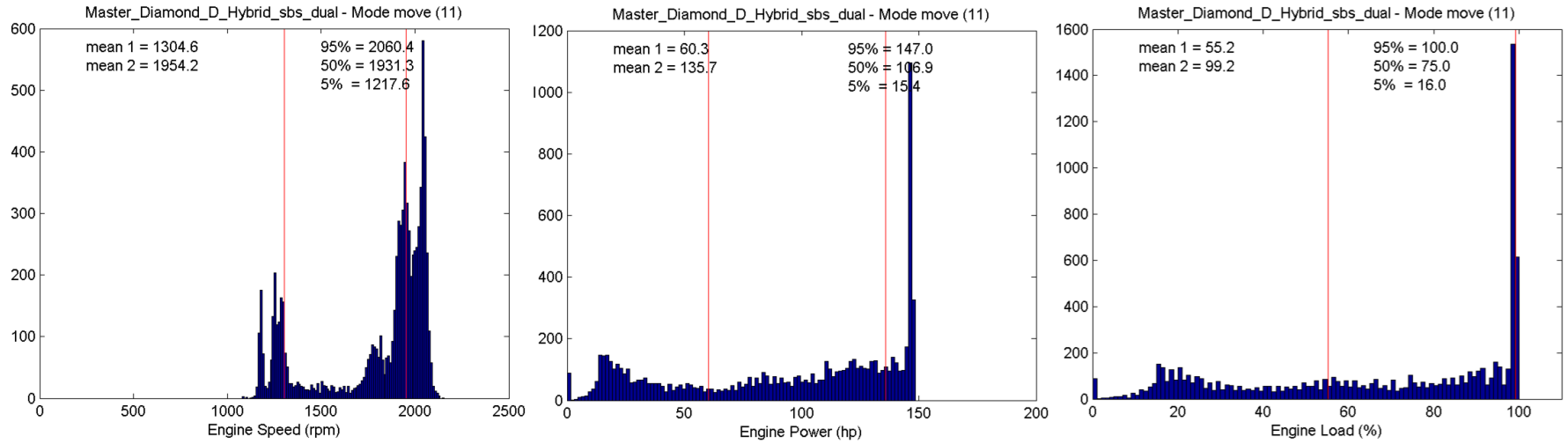


Figure 4-37 Engine speed, power, and % load for the hybrid excavator at DD, mode travel.

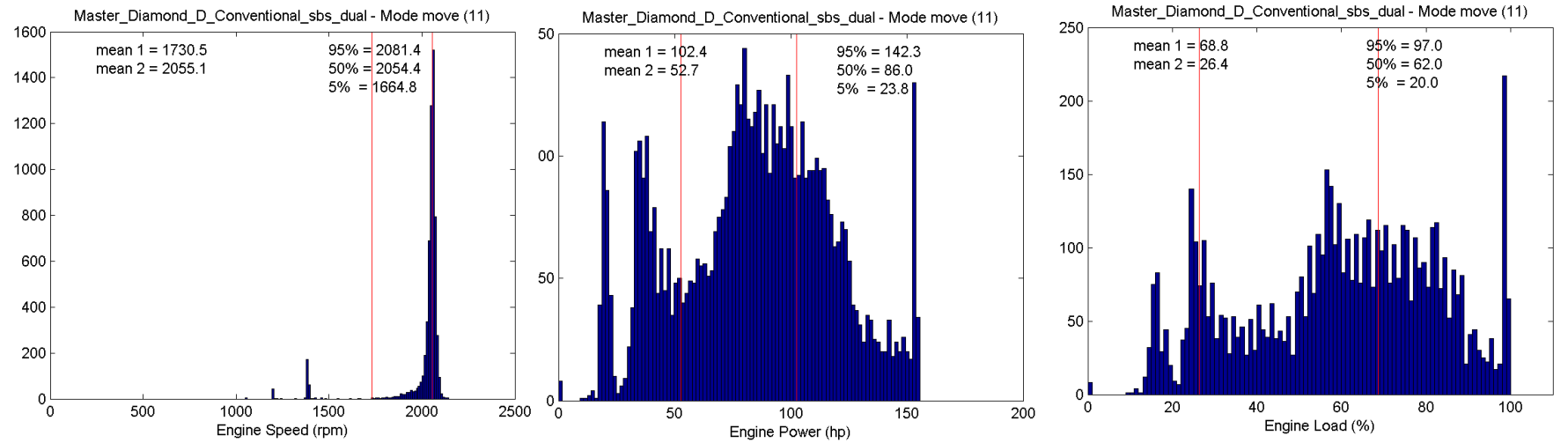


Figure 4-38 Engine speed, power, and % load for the conventional excavator at DD, mode travel.

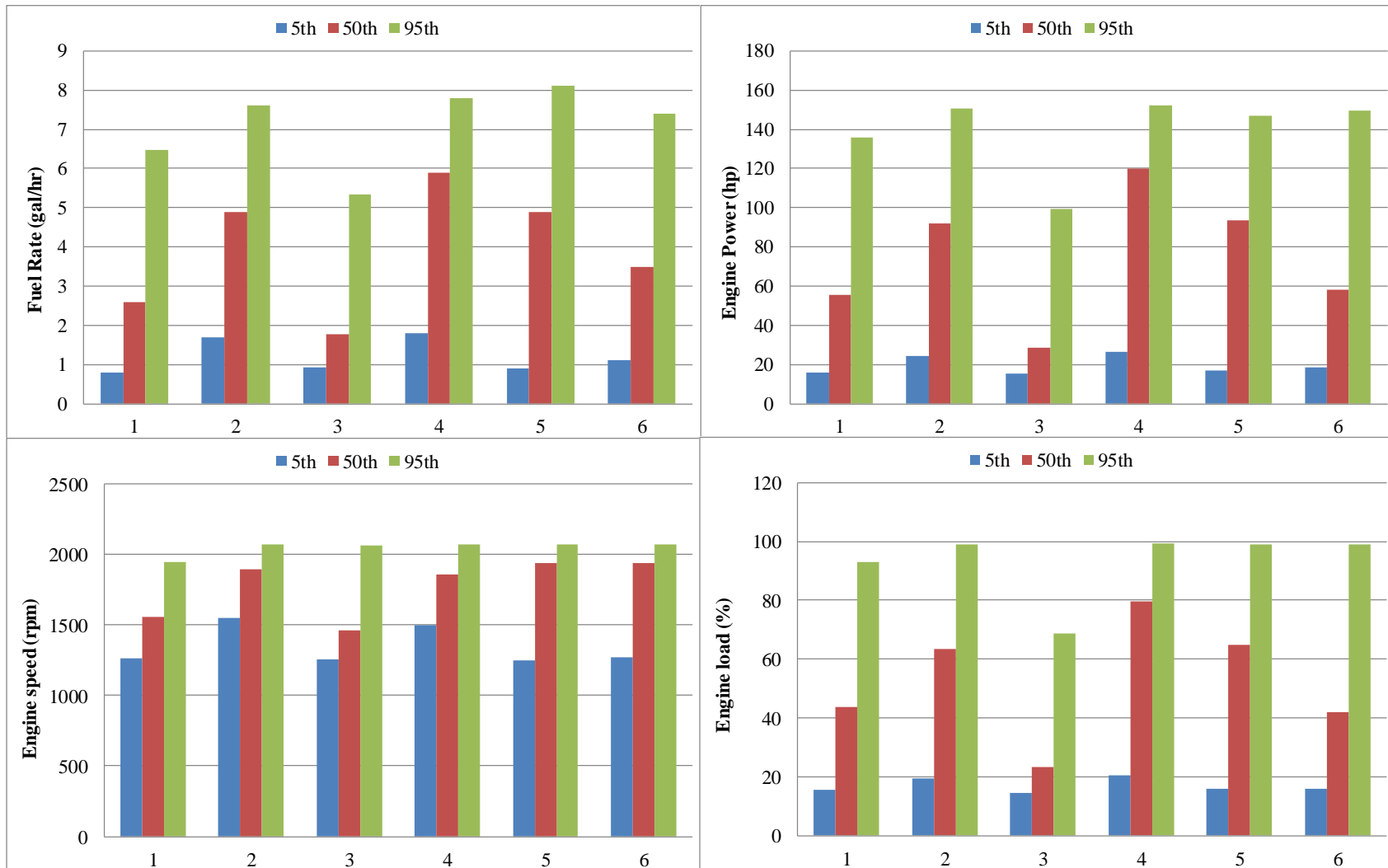


Figure 4-39 Engine fuel rate, power, speed, and percent load summary statistics

#### 4.2.9 *Result summary*

In summary the statistics show that the event modes identified represent the operation of the excavator for both the hybrid and conventional units. The modes selected cover a range of 50<sup>th</sup> percentile power from 30 hp to 120 hp and represent a wide range of operation. The fuel rate varies from 6 gal/hr to just under 2 gal/hr and the engine speed varies from 1480 rpm to 1900 rpm for the 50<sup>th</sup> percentile operation. These ranges represent a wide range of operation and thus, suggest the activity data collected are reasonable for recommending a robust duty cycle.

The proposed duty cycle should consider similar statistics and thus should cover 30 to 120 hp, 2 to 6 gal/hr and 1500 to 1900 rpm on average. Also, all modes were found to be similar between the hybrid and conventional except for the move/travel mode. The proposed duty cycle will include each of the 6 modes which include a specific element of travel. Idle will be integrated with the various modes to represent the real operation. Additionally idle will be considered separately given its significant contribution to the overall activity for in-service operation.

## 5 Duty-cycle development

Characterizing emissions and fuel economy benefits between in-use equipment requires a repeatable and relevant duty cycle. This is especially true for comparisons between hybrid and conventional units where “apples to apples” comparisons are critical for a true understanding of the impact hybrids may play in the real world. For this program, activity measurements from CAT D7E bulldozers and the Komatsu HP-215LC-1 excavators were used to develop accurate, representative, and repeatable duty cycles for the emissions measurements.

Development of a duty cycle involves performing activity measurements to study “location specific” behavior. Typically this is done with on-road vehicles on a second by second basis [1-4, 5 and 6]. The data is then analyzed and a speed versus time trace or torque/rpm versus time trace is created to realistically mimic that behavior in test cycle of reasonable time duration on a chassis or engine dynamometer, respectively. The speed or load versus time traces is developed from statistics that best match selected trips or behaviors. The statistics used are typically average vehicle speed, engine rpm, engine load (torque and power) and idle time. The trips and behaviors are defined by key-on and key-off events and operational behaviors like idle, low speed, and high speed operation.

The approach of combining behaviors can also be relevant for off-road, but not when the cycle is being developed for an in-use test [7]. The underlying statistics for an in-use off-road duty cycle will be different from engine speed, power, and velocity. Off-road activity is typically based on moving material. Bulldozers push material, excavators dig and lift, scrapers remove and distribute material, and backhoes dig, move and load. Thus a representative in-use duty cycle should consider material movement.

The underlying statistics for off-road reduce to how far material is moved, at what rate is it moved, and how much is moved. For the material being moved the resulting engine speed, power, and velocity can be observed to show consistency between tests. Thus, the approach for the off-road equipment will be to move specific quantities of material, specific distances, at specific rates, while utilizing real time ECM, GPS, and emissions data to confirm consistency between tests. In addition, the duty cycle for construction equipment includes constant speed operation with power take off (PTO) and significant idling where engine speeds tend to be more constant (unlike on-road applications). Thus, the engine load is a result of the work the equipment is doing, so one needs to understand the modes of operation for off-road equipment before a duty cycle can be developed.

Instead of defining a “trip” for off-road operation, we will approach the analysis from distinct “events”, which are short duration activities represented by off-road conditions. Trips are good for on-road key-on to key-off behaviors and “events” are good for off-road equipment with unique operational behaviors, as will be described below for the bulldozer and excavator off-road cases.

### 5.1 Caterpillar bulldozer

For the bulldozer the main function is to move material by pushing relatively short distances. The bulldozer is designed with various blade dimensions and relatively simple attachments that focus on pushing material. As such, a bulldozer duty cycle should be primarily concerned with moving material. Bulldozer sizes are selected to move material most efficiently. Typically, efficiency is based on which bulldozer moves the most material for the least cost (i.e. lowest \$/ton moved). For example operators described the D7E bulldozer as moving material faster (km/hr), but with more pushes compared to the larger D9 bulldozer that moves slower, but requires fewer passes. Thus, the real in-use duty cycle for the bulldozers was one that focused on pushes, pulls, and compaction using different parameters such as event length, speed, and tons moved. Other parameters could include

material density, grade, idle, and other unique bulldozer operations identified from discussions with participants.

#### *5.1.1 Caterpillar bulldozer published duty cycle*

Caterpillar does not have a published duty cycle like Komatsu, but they have participated in evaluations of their bulldozers with D7E customers. Recently the Department of Defense performed an evaluation of the hybrid bulldozer with a conventional bulldozer by pushing dirt a specified distance for a 30 square meter pad [7]. During the study they pushed dirt with a D6, D7R, and the D7E and compared their performance. It is unclear how far they pushed the material and at what rate, and over what amount of time. The results suggested 10 to 40% fuel economy improvement over baseline units (D7RII and D6) and the benefit depended on light and heavy dozing where light dozing performed better for the hybrid.

#### *5.1.2 Third-party bulldozer evaluations*

WM also performed their own in-house evaluation of the D7E compared to the D8R and D9T at their facility in El Sobrante (not published). These tests were performed on flat ground pushing dirt and pushing “Packers”, compacted residential trash. The duty cycle consisted of pushing a large pile of two materials 30 meters each. The bulldozers were compared by pushing as many times as necessary to complete the job. The D7E and D8R did the work in 3 pushes and the D9T did it in 2 pushes. The outcome suggested the D7E showed 30% fuel savings compared to the D9T and D8R for moving the same material 30 meters. The fuel consumption was not directly measured during the tests which could change the reported benefits. Also there is interest in doing these same tests on a positive grade since this is a common situation in practical landfill operations and possibly other fleet operations.

#### *5.1.3 UCR analysis*

The duty cycle development for the Caterpillar D7E bulldozer is based on measurements from WM, RC, and OC. WM is a solid waste landfill operation, RC is a rock quarry and OC is a water district. Each facility represents a unique type of operation that was characterized using ECM and video data, as presented earlier. The data used to develop the proposed duty cycle is represented by more than 53 hours of valid ECM and GPS data, over 400 hours of valid video data, and over 13,000 unique events.

#### *5.1.4 Proposed duty cycle*

Based upon the statistics provided in the results section, the following represents typical bulldozer operation for WM, RC, and OC for the hybrid and conventional units. UCR recommended targeting the following metrics:

- heavy pushes
- light pushes
- idle
- heavy push up grade
- in-service operation

Engine load, fuel consumption, and unit speed will be controlled by operators for the proposed cycles. This approach is considered reasonable given the variability expected with in-service testing and the need to allow operators to control the bulldozer equipment based on their experience. One cannot follow a driving trace of velocity, power, or engine speed for dozing operations given all the variables that can affect unit performance. The best metric is moving piles a specific distance and letting the operator control the rate. One cannot ask an operator to push at 50% load since 50% load is not the same for the hybrid and the conventional.

### *Push distance*

The activity data demonstrated there is a range of push lengths and these vary by participant. WM has predominantly short pushes whereas OC and RC have slightly longer pushes. Thus it was decided to use statistical tools to determine the most frequent push length that represented all participants D7E and conventional usage. Three lengths were decided on: 10 meters, 30 meters, and 80 meters push lengths.

### *Push effort*

The data shows two types of pushes: light and heavy as discussed in Section 4.1.8. The light pushing is associated with doing dressing type work on roads, in the river bed, or other areas. The heavy pushing is when there is a large amount of material to move and the operator pushes as much as possible as fast as possible. According to the data collected and fleet distributions (i.e. private fleets dominate public fleets) we expect more heavy pushes to be performed over light pushes, thus bullet 1 was divided into 3 cycles short, mid and long events. Bullet 2 represents only 1 cycle for a mid-length event.

The light push is a difficult cycle to recreate, but will be attempted with either light material or a light depth push. We must control the amount of material being pushed and not the results of doing the work. Thus, the only way to change load is to force doing the same activity of moving heavy and light piles to represent real in-use work. UCR sought input from WM, OC, and RC for their experience in performing the light push. In the end, a post-test analysis was used to throw out data that exceeds statistical outlier tests such as the f-test and t-tests statistics of 40 CFR 1065. See Section 5.2.3 for details for on-site post-test evaluations.

### *Test Location*

The original plan was to perform the test cycles at each of the three participant locations. One week of hybrid and one week of conventional. Since there was not a direct conventional comparison we considered the following testing options.

#### *Option A*

Consolidate all the testing at one location. This would involve testing one of each baseline conventional (D6T and D8T) and each of the participant D7E hybrid bulldozers at WM. WM would operate their D7E and all three conventional units. OC and RC would operate their respective D7E's at WM. Each unit would be tested following the proposed duty cycles 1-7. One difficulty this could potentially cause is 5 weeks of condition change between hybrid and conventional. We would need to confirm conditions are similar using experience at WM and others (possibly measure soil moisture and surface hardness).

#### *Option B*

Consolidate all the testing for the conventional units at one location and test the hybrids at each participant location. This would involve testing one of each baseline conventional (D6T and D8T) and the D7E at WM. The hybrid testing would be done at each of the participants WM, OC, and RC using different setup conditions. Each unit would be tested following the proposed duty cycles 1-7.

#### *Option C*

Perform one hybrid and one conventional at each participant location. This would limit the number of conventional units to the D6 or D8 at each facility. For example one scenario would be to test the D7R at WM, D8 at RC and D6 at OC. Each unit would be tested following the proposed duty cycles 1-7.

### *Test cycles*

Seven test cycles were proposed where two media and two elevation grades are considered. All cycles were to be performed in triplicate for statistical analysis and good engineering practice. The cycles were to be performed in the order of importance since some field difficulties may occur, preventing completion of all the cycles. The test cycles are summarized as follows:

- **heavy** push **10** meters (10<sup>th</sup> percentile distance)
- **heavy** push **30** meters (50<sup>th</sup> percentile distance)
- **heavy** push **80** meters (90<sup>th</sup> percentile distance)
- **light** push **30** meters (50<sup>th</sup> percentile distance)
- **idle** for 10-15 minutes
- **heavy** push **30** meters (50<sup>th</sup> percentile distance) up **10% grade**
- **In-service with std. grade** operation <sup>1</sup>  
<sup>1</sup> (walking/dressing slopes, building pond sides etc...)

In general, the largest impact on emissions was expected to be the push length – thus three push lengths were presented. This is important since the bulldozer push length is heavily dependent on operational use. The next most important impact was expected to be the media being pushed – thus both a low and a high density material were recommended. Two unique operations were also selected – one for idle and the other for walking slopes/building ponds (used by all three participants). Finally, the last option is to push on a grade (at the recommendation of WM).

#### *5.1.5 Evaluation of proposed duty cycle*

One concern about performing in-use repeatable testing is identifying some parameter to confirm consistency between tests. UCR evaluated each test for distance, speed, fuel consumption and average power. It was expected that there would be more variability than laboratory testing where 1-2% coefficient of variation (COV) was expected for fuel consumption (chassis or engine dynamometer). Others have found in-use repeatability for off-road test cycle to be with-in 7% for fuel consumption when using non 1065 approved PEMS [7]. It was also expected that the distance COV would be more repeatable at around 5% or less. These metrics were used to evaluate the test cycles proposed after each test. Corrections to test and additional tests were performed for outliers. Testing standard operating procedures (SOP's) provide more detail regarding UCR's approach for data checks and testing practices (see Appendix E).

#### *Problems encountered with the original test plan*

To facilitate the proposed test plan eight loads of three inch minus rock were delivered to the test site (see Figure 5-1). The eight loads weighed in at around 13 tons each for a total of 104 tons of material. The eight piles were distributed into one long row as shown in Figure 5-2.



**Figure 5-1 Delivery of one load of three inch minus rock (~13 tons)**



**Figure 5-2 Delivery of eight loads of three inch minus rock (104 tons)**

The basic idea was to move the material with full blade pushes for the 10, 30, and 80 meters (heavy pushes). Then move the material with  $\frac{1}{2}$  to  $\frac{1}{4}$  blade pushes for 30 meters (light pushing). Then do the same thing on a grade and then, with time permitting, do an in-service operation called “walking the slope”



The first test was to move the 104 tons of material with a 30 meter push (i.e. the 50th percentile push). The material was positioned into a long row as shown in Figure 5-2. The bulldozer was positioned in front of the pile at one end and the operator was instructed to push the pile 30 meters. Then the bulldozer backed up and pushed the next section of the pile.

The material did not remain in front of the blade and spilled off during the push. The problem with the material spilling off the blade is that this results in a significant loss of load on the engine. The load dropped from 100% to less than 50%, see Figure 5-4. Figure 5-3 A-D shows the pile height on the blade at 5, 10, 15, and 30 meters. The figure shows how the material is falling off the blade where about half the pile is missing at 15 meters and less than 25% remained by the end of the 30 meter push. The same trend repeated itself for all the pushes as shown in Figure 5-5 where the D6T is shown after completing its 5th pile push.



**Figure 5-3 D6T bulldozer pushing a single 13 ton full load pile 30 meters**

<sup>1</sup> A) 5 m, B) 10 m, C) 15 m, and D) 30 meters into the push

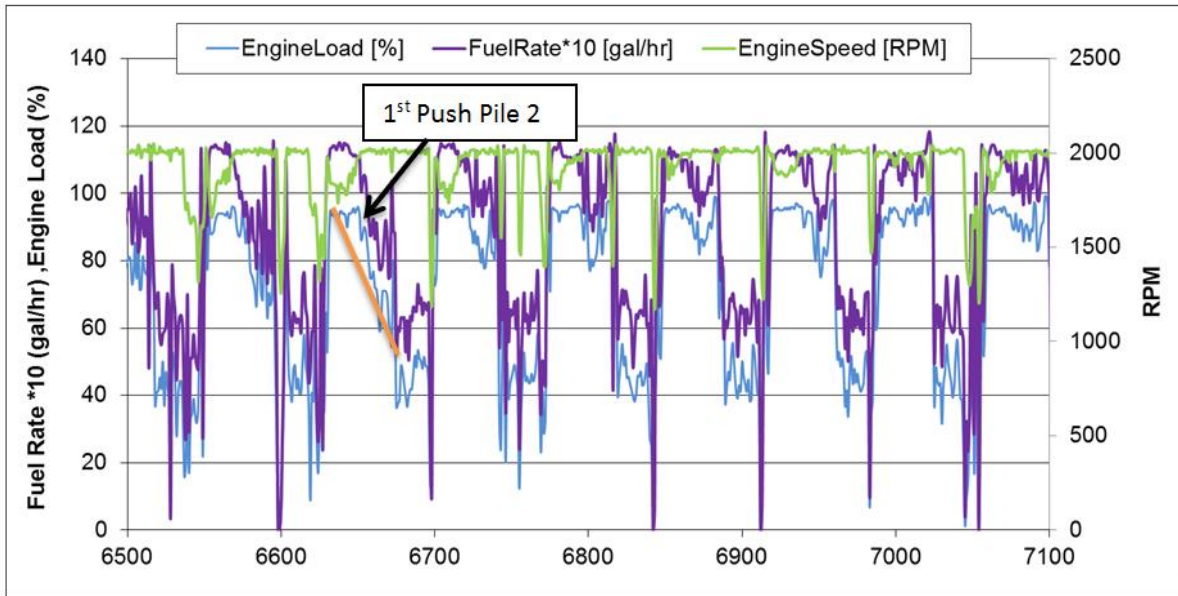


Figure 5-4 D6T Controlled pushing 30 meters for portions of the eight 13 ton piles

The material was spilling off the blade making what is known as “windrows”. Forming windrows is not an uncommon feature for bulldozing. Figure 5-8 shows a picture of windrows at Orange County Water District during pond maintenance. The problem with creating windrows is you cannot move the entire pile in a discreet number of pushes and thus moving piles is not repeatable or accurate.



Figure 5-5 D6T 30 meter push after the 4th pass of the bulldozer



**Figure 5-6 D6T Rock Pile pushes showing windrow formation.**

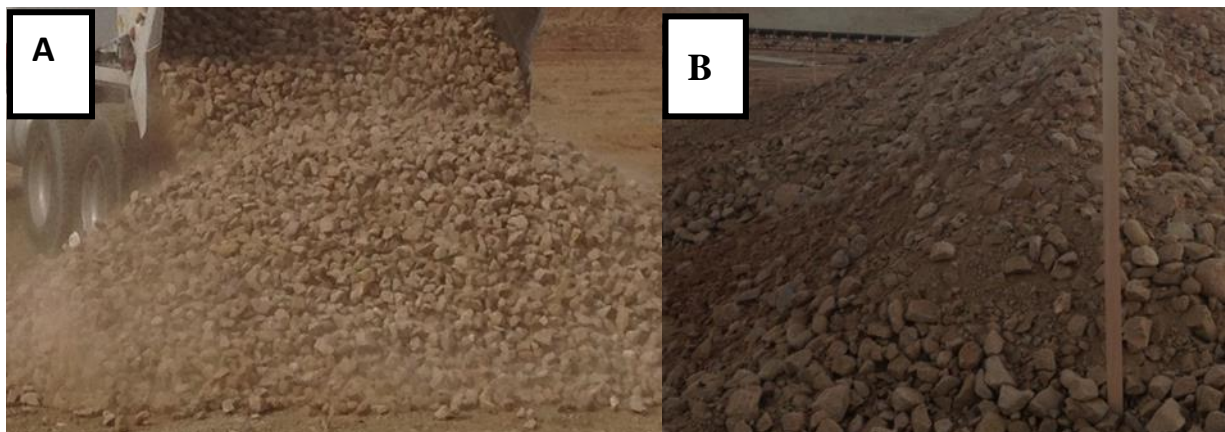


**Figure 5-7 Massive windrows (~3 ft high) after a few full blade pushes.**



**Figure 5-8 Blade spillage or "windrows" during OC bulldozing**

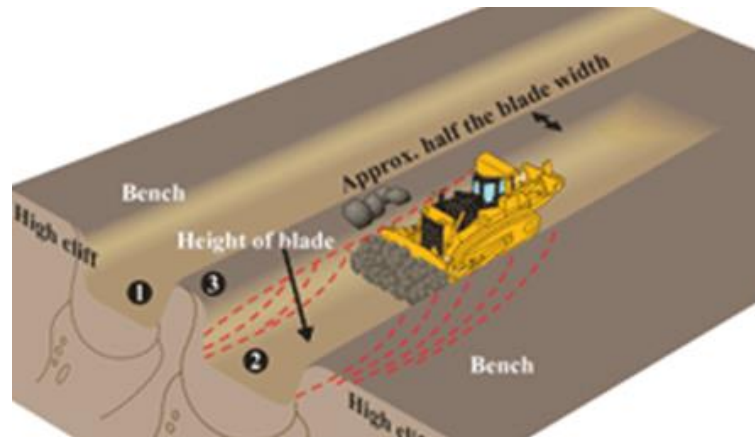
Additionally after moving the piles for 1 hour it was noticed that the three-inch minus rock was mixed completely with dirt, see Figure 5-9. The rock was no longer the same density as when it was originally weighed. This means the load changed and is most likely higher to some unknown value. The load could be re-weighed after testing, but it may continue to vary over time. Not knowing the material weight prevents having a unifying metric between bulldozer types and thus prevents quantifying the results.



**Figure 5-9 Material changed from 0 hours "A" to 2 hour "B" of bulldozer pushing**

### Alternative test plan

One approach to pushing a known amount of material a distance is “track dozing”<sup>4 5</sup>. Track dozing can be done by creating channels for the bulldozer to operate in (see Figure 5-10). The material is placed at one end and then pushed the distance of the channel. This is not a practical approach for the project scope and layout at the landfill.



**Figure 5-10 Example of method to prevent windrows**

Another approach to pushing a specific mass is to push a large heavy object. Two large rocks, representing nearly the same weight as the piles, were acquired and pushed the 30 meters, see Figure 5-11. Unfortunately the load varied from 50% to 90% and was very oscillatory verses the relatively constant 80-100% heavy push load seen during the activity testing results. The load appeared to oscillate because the rocks would dig into the surface then roll over. More advanced push objects and skids would be necessary to facilitate a practical push method.

---

<sup>4</sup> Caterpillar construction guide, “CAT Hauling Systems, More Ways to Work.” AEXQ0544-01, 2010 Caterpillar Inc.

<sup>5</sup> Komatsu main website, “Bulldozer Operations Methods for Saving on Fuel Consumption and Improving Fuel Efficiency“ see link, <http://www.komatsu.com/ce/support/v09202/index.html>, 2005



**Figure 5-11 Pushing large heavy objects as an alternative to pushing piles (7.5 and 3.5 ton rocks)**

### *Proposed pull test*

Another option is to pull the load with a controlled weight. This is commonly done for evaluating performance of tractors during tractor pull competitions (see Figure 5-12). Most tractor pull configurations do not measure the load required to pull a test, but rely on pulling a sophisticated skid a distance. The load on the skid incrementally increases with distance, where the winner is determined by who goes the farthest. Thus the tractor pull idea would need to be modified to work for this application since load is needed not how far the unit went.

Researchers at the University of Maryland describe pulling a load as the standard reference method for bulldozer performance. Bulldozers performance is measured by their “draw-bar” tractive effort <sup>6</sup>. The draw-bar is the amount of force pulled onto a load cell between a load and the tractor. This effort is similar to the brake power on an engine dyno. It is how much force a bulldozer can pull while performing a task. According to the presentation, bulldozer manufacturers sometimes rate their machines capability by the unit’s draw-bar force at rated and maximum conditions <sup>3</sup>.

There are several 3<sup>rd</sup> party manufacturers that provide draw-bar skids or trailers used to measure draw-bar loads <sup>7</sup>. One can either measure the pulling load, or one can pull a known load a distance and use the emissions and ECM metrics for quantification. These draw-bar skids are expensive and would need to be custom designed for this research. Another option is to use a large bin loaded with material and measure the load from the PEMS equipment and the ECM data.

We measured the load between the tractor and container with an integrated a 20,000 lb NIST traceable S Beam load cell from Omega Engineering (Model LCCD-20k). The signal was recorded

---

<sup>6</sup> Assakkaf, Ibrahim “Dozers Construction Equipment and Methods”, Department of Civil and Environmental Engineering, University of Maryland, College Park, Spring 2003.

<sup>7</sup> BriTcom International, “Dolly Type Drawbars” <http://britcom.co.uk/chassis-engineering/trailer-building/dolly-type-drawbars>, web link

in real time using a CR10x data logger from Campbell Scientific. The accuracy of the load cell was 0.01% FS repeatability with a 0.03% linearity specification. Figure 5-13 shows a picture of the D6T pulling a container with approximately 13 tons of rock. Figure 5-14 shows a picture of a bin loaded with material to be pulled. The total weight of the bin is weighed for the exact load moved. The ability of pulling an exact amount of material is repeatable and quantifiable. The accuracy in the methods is also very good.



**Figure 5-12 Typical tractor pull approach for evaluating tractor performance**



**Figure 5-13 Pull test approach with D6T and container loaded with 13 tons of rock**





**Figure 5-14 Pull test approach showing 3 loads of 3" minus rock in container (#3 bin D8T)**

Table 5-1 shows the repeatability of eight pulls, four in the west direction and four in the east direction. Overall the engine fuel, power, CO<sub>2</sub> and NO<sub>x</sub> showed less than a 3% coefficient of variation (COV). PM showed less than 10% COV even at these low DPF-out levels. The low COV is at the same level for typical chassis dynamometer and only slightly higher than engine dynamometer testing (~ 1.5%). The fact that the COV was less than 3% suggests that pulling a load is repeatable and accurate.

**Table 5-1 Summary of the D6T performance data pulling a loaded container**

Power bhp	Torque ft-lb	Fuel kg/hr	Vel GPS km/h	Time Specific Emissions (g/hr)			
				CO2	NOx	THC	mg PM 3
196.8	516.5	36.5	3.7	115450	202	2.5	43.8
197.3	521.5	35.4	4.0	112089	197	2.5	41.5
198.2	518.6	38.2	3.6	120765	199	2.0	45.1
197.0	516.4	35.9	3.7	113479	211	2.3	41.8
204.8	536.0	37.4	3.8	118201	212	1.8	43.8
195.0	510.2	35.9	3.8	113654	202	2.0	39.3
203.4	533.3	36.9	3.5	116617	206	2.1	44.1
198.9	521.8	36.6	3.7	115751	204.2	2.2	42.8
3.7	9.4	1.0	0.2	3026	6.0	0.3	2.0
1.8%	1.8%	2.6%	4.8%	2.6%	2.9%	12.3%	4.7%

<sup>1</sup> ECM reported fuel rate

<sup>2</sup> Power estimated from published lug curve and % load, see detailed work sheet

<sup>3</sup> Total PM using gravimetric span method and not the model alpha methods. Units of mg/hr or mg/kgfuel or mg/hp-h.

<sup>4</sup> Carbon balance fuel rate calculation using gaseous PEMS

The typical speed during a loaded pull was 4 km/hr on average with about 5 km/hr steady speed. According to the drawbar pull force this suggests the D7E can pull 22,000 lbs, see Figure 5-15. Based on drawbar measurements using a load cell and a 13 ton skid container we pulled with the D7E and measured 7,000 lbs at 60% engine load. Max engine load for the D7E is 80% and 100% for the D6T. Thus the loaded pull for the D7E was 75% of maximum and the D6T was 85% of maximum. UCR did not add more load to the D7E as it would have prevented the D7E from turning where additional power is needed. Thus UCR decided to stay at the same container weight. The D8T needs a larger load to produce similar powers given its much larger engine displacement and rated power.

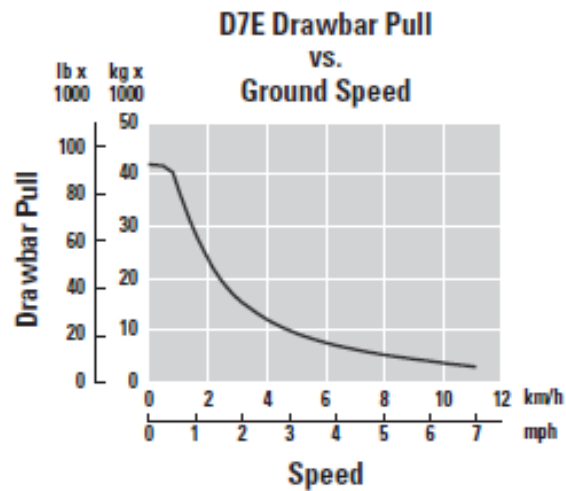


Figure 5-15 D7E drawbar pull from caterpillar published material <sup>8</sup>

#### *Test plan comparisons*

The next important question is, “How comparable is pulling a load to pushing a load?” This section describes the similarity between the activity in-service measurements and the pulling test. A follow up question is “how comparable is the real-time pull data to the in-service activity push data?”

Figure 5-16 and Figure 5-17 show the real time fuel rate and engine speed data for the D7E and D8R in-service measurements. Fuel rate was selected for the comparison since fuel usage is an absolute comparison to engine load between units and an important performance parameter. The D7E T4i has the same ACERT 9.3 liter engine and aftertreatment system (ATS) as the D6T T4i where the D8R T3 has a larger 15 liter engine and no ATS. The power rating on the D7E engine is slightly higher than the D6T and the D8R is much higher. Thus, one would expect the magnitude of the fuel consumption to be higher for the D7E and D8R compared to the D6T.

The D7E fuel consumption during a full push was flat at 13.5 gal/hr and around 6.5 gal/hr during an unloaded pull back from a push (i.e. preparing for the next push). The D8R fuel consumption was less consistent, but still fairly flat at 18 gal/hr for a loaded push and about 11 gal/hr for the pull back. The in-service data suggests a bulldozer pushing (or pulling) a heavy load should have a fairly flat near maximum fuel usage and a much lower fuel usage when preparing for the next loaded push (i.e. the pull back).

<sup>8</sup> Caterpillar D7E Track-Type Tractor product brochure document number AEHQ60212 (12-2009) [www.cat.com](http://www.cat.com)

Figure 5-18 shows the real time fuel rate while pulling a container load of approximately 13 tons. The engine fuel consumption is much more consistent and only varied from 10 to 11 gal/hr. During the pile push test the fuel rate varied from 11 to 6 gal/hr and was inconsistent between pushes, see Figure 5-4. The pull test agrees with what was reported for the in-service D7E and D8R activity results. The D6T push test did not agree well with either the D7E or D8R activity results.

In general, these results suggested the proposed pull test agreed well with in-service operation and was thus, representative for real bulldozer operation.

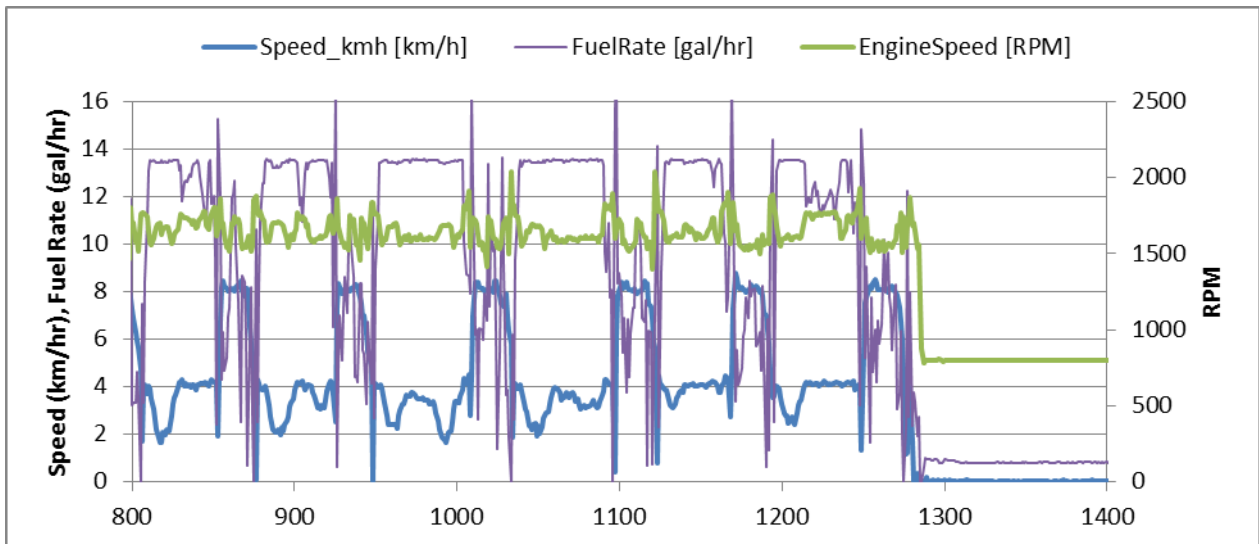


Figure 5-16 Typical unit speed, fuel rate, and rpm for a D7E in-service at WM

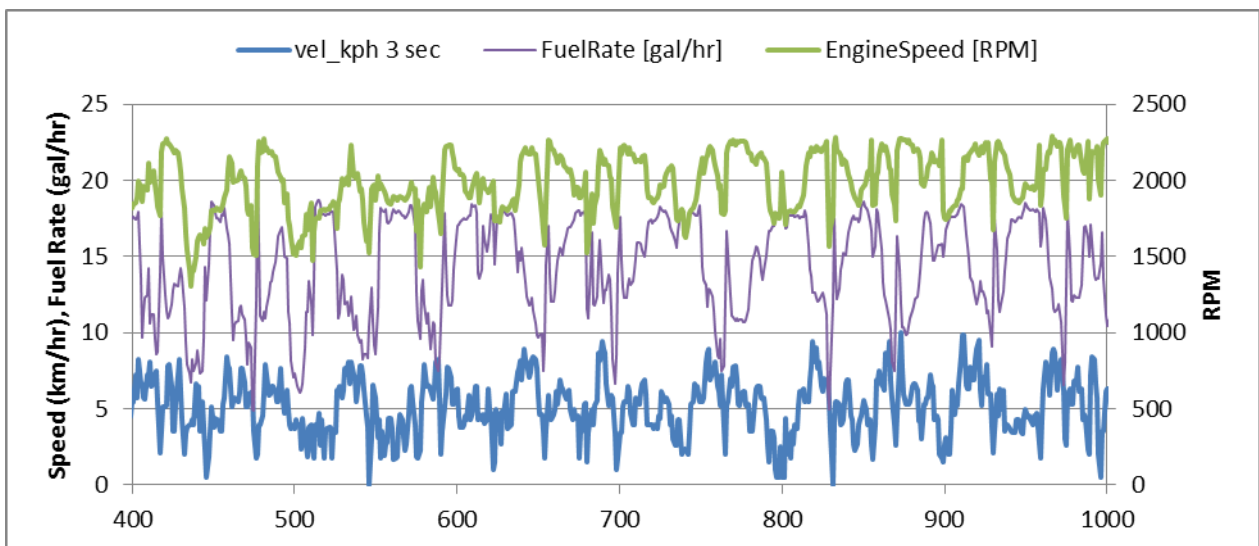
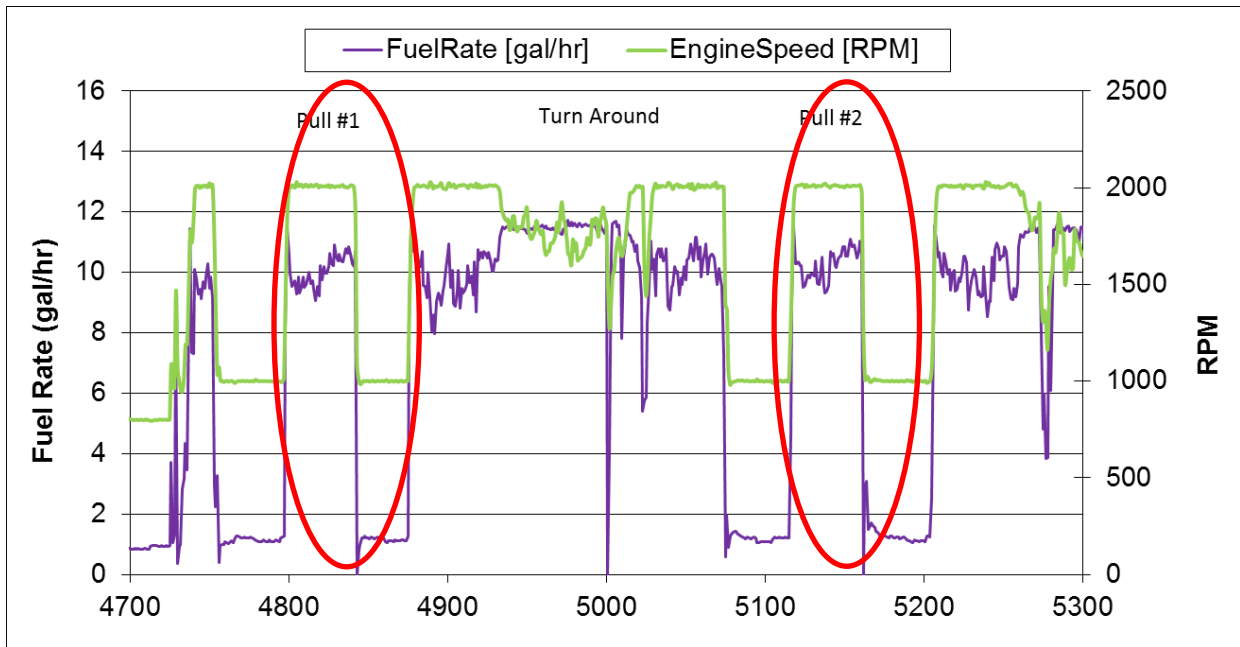
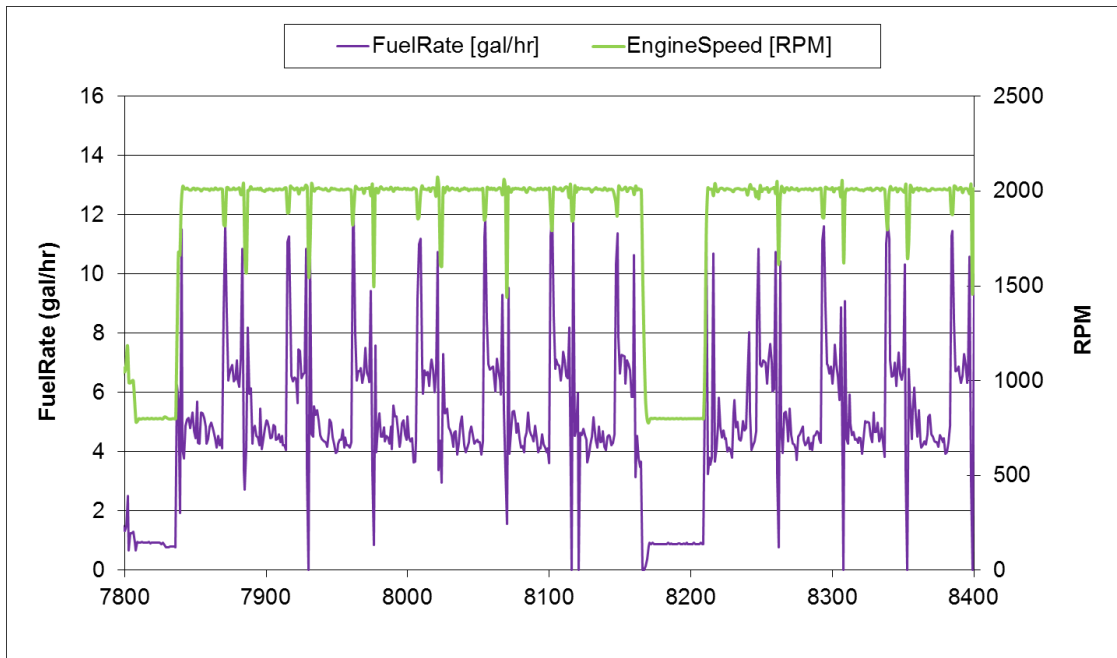


Figure 5-17 Typical unit speed, fuel rate, and rpm for a D8R in-service at WM



**Figure 5-18 D6T Controlled 30 meter pulling of a fixed loaded container**

Figure 5-19 shows the fuel consumption results from forward and backwards operation. The operation represents the “pull back” operation identified during the in-service bulldozing. The fuel consumption for forward and reverse unloaded “pull-backs” at 30 meters is 5.0 gal/hr (forward) and 6.5 gal/hr (reverse) and are repeatable. The results from Figure 5-19 were be utilized in conjunction with the results from Figure 5-18 for a total emission factor for each distance the material was moved.



**Figure 5-19 D6T Controlled 30 meter forward and backwards with no container**

### 5.1.6 Revised duty cycle

Based on all the discussion on previous section, seven test cycles were targeted. Both container pull and in-service push were evaluated. Seven test cycles were proposed where two different media and two different elevation grades were considered. All cycles were performed in triplicate for statistical analysis and good engineering practice. The cycles were performed in the order of importance in case some field difficulties occurred, preventing completion of all the cycles. The targeted test cycles are summarized as follows:

- **Heavy & medium** push **10** meters (10<sup>th</sup> percentile distance)
- **Heavy & medium** push **30** meters (50<sup>th</sup> percentile distance)
- **Heavy & medium** push **80** meters (90<sup>th</sup> percentile distance)
- **Idle**
- **In-service heavy & medium** push operation
- **Controlled in-service** with **50' x 50'** pad **light & full** cut operation
- **In revenue service** with **std. grade** operation

#### *Proposed test method*

Since we could not reproduce the same push test, the tests were performed in triplicate at two and three different container weights to simulate the bulldozer's forward push motion. For the D6T and D7E two containers were used, one heavy for the heavy push, one light for the medium push and a third heavier container was added for the D8T to estimate its maximum capacity. The D6T, D7E, and D8T were all pull the same containers and the draw force was measured with external load cell. Since the D8T had a significantly higher power rating, a third heavier container was utilized. The heavier container was prepared at approximately 80 to 90% of the D8T's measured percent engine load.

#### *Controlled pull tests*

The pull tests were evaluated over three different distances of 10, 30, and 80 meters for each of the different containers. In addition, an extended idle test was performed and a back and forth test with no load was performed. The back and forth test was performed at the same 10, 30, and 80 meter distances to simulate the bulldozer's backward motion right after the forward push motion. The detailed the data analysis is discussed in the next section.

The proposed test plan is summarized as follows:

- Pull a **MEDIUM container** and weight the emissions at **10, 30, and 80** meters
- Pull a **LIGHT container** and weight the emissions at **10, 30, and 80** meters
- Pull a **HEAVY container** (for the D8T only) and weight the emissions at **10, 30, and 80** meters
- Move **forward and backwards** at **10, 30, and 80** meters to assist with above calculations
- **Idle** for 10-15 minutes

### *Bulldozer controlled pull analysis*

The in-use emissions duty cycle is based on a push-pull type of operation. The push is a loaded operation and the pull is an unloaded operation of work. Each push-pull combined operation defines the type of work performed by a bulldozer.

Each operation thus needs to include the performance of the push and pull operations. The approach considered was to evaluate the push and pull separately.

Due to space and time limitations, the draw bar pull was conducted over fixed course of 45 m. The test was performed for both directions, 3 to 4 time for each unit and bins.

The analysis was based on the draw force on each bulldozer. This was accomplished by averaging the emissions from 0-10m, 0-30m, and 0-80 m. The calculation of emissions from 0-10 and 0-30 was direct from the database. To get emissions for 80m we took the emissions from 0-10 and 10-40 and weighted them as shown in the equation below to get 0-80 for each pull. Then the overall was averaged together with the pullback emissions to come up with a total push pull trip as done by the bulldozer.

Drawbar push calculations:

$$C_{10\_push} = C_{10\_push}$$

$$C_{30\_push} = C_{30\_push}$$

$$C_{80\_push} = \frac{C_{10\_push} * 10 + C_{30\_push} * 70}{70}$$

Push + Pull Calculations (final value)

$$C_{10\_total} = C_{10\_push} + C_{10\_pull}$$

$$C_{80\_total} = C_{80\_push} + C_{80\_pull}$$

$$C_{80\_total} = C_{80\_push} + C_{80\_pull}$$

$$C_{80\_total} = \frac{C_{10\_push} * 10 + C_{30\_push} * 70}{70} + C_{80\_pull}$$

$$C_{10\_total} = \frac{C_{10\_push} + C_{10\_pull}}{Tons}$$

### *In-service tests*

In addition to the contrived pull test. UCR also recommended evaluating the in-service performance of each machine. In-service testing included controlled in-service testing where the mass excavated was calculated and in-revenue service where the amount of material was not known. Since in revenue-service test push material cannot be controlled, the results will be mainly used to support the data from contrived pull test and possibly for developing an in-use emission factor. For the controlled in-service testing UCR was able to quantify the material moved and this was evaluated on a per ton basis.

For general rock pushing work, each dozer was tasked to push one-inch minus rock piles for about 60 minutes at the beginning of each day. The task will not only warm up the dozer's ATS for contrived pull test but also let the operator get used to the machine's performance. This is especially

important for rental units. From this pushing data UCR integrated high and low load operations. High load was represented by full blade pushes and light operation was represented by windrow light pushing typically found in bulldozing, as described in the activity analysis section.

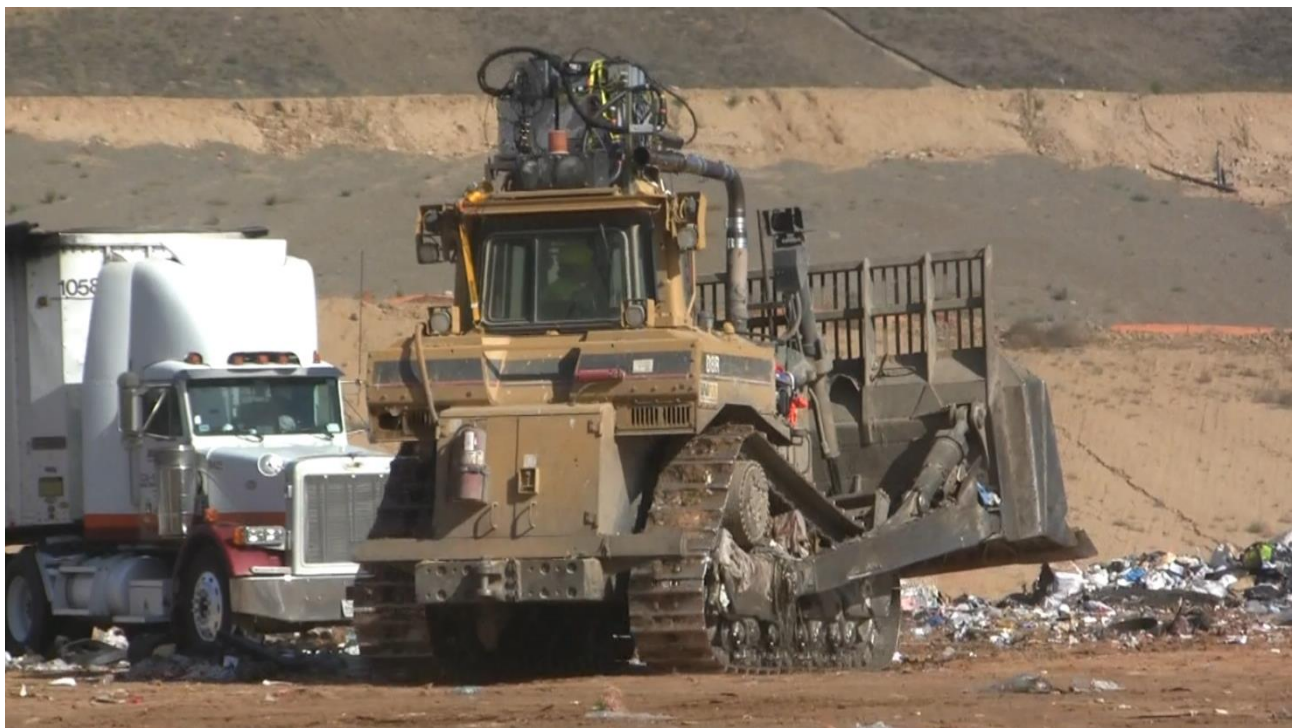


**Figure 5-20 In-service dirt and 6in minus rock pile pushing – D6T.**

For in revenue-service trash pushing, only bulldozers with specially equipped undercarriage and blade could be allowed into the trash. Thus, only the WM D7E was tested for in-service trash push. We also tested WM's tier 2 2003 D8R in a previous program. The emissions were drastically different than the new tier 4i D8T due to equipment age and tier level, however, fuel consumption will still be a good metric to for comparison consideration, especially for those who are interested in replacing their older bigger machines with the new D7E.



**Figure 5-21 WM's D7E in-service trash push at El Sobrante landfill near Corona, CA.**



**Figure 5-22 WM's D8R in-service trash push at El Sobrante landfill near Corona, CA**

*Controlled push testing*

For the Orange County Water District's controlled in-service work, we brought a conventional unit from Johnson Machinery to Orange County's facility to compare with the D7E. We utilized the D6T since the D6T is typically used in general construction compared to the D8 for landfill operation, as discussed in Section 0. The in-service test involved cleaning the slope similar to OC's daily activity at the levees and lakes.





**Figure 5-23 OC's D7E performing slope cleaning in-service push river maintenance.**

One other important task for OC's daily work is dirt excavation; the idea is to clean off the very top layer to allow better water percolation. This is similar to work performed during general construction projects. Earlier bulldozer evaluations also perform this task. The test was performed in a 50'x 50' pad with two blade depths, 6" for light and 12" for heavy cut. There were 3 repeats of each depth for each bulldozer and the amount of moved material was measured.



**Figure 5-24 OC's D7E performing 50'x50' pad cut in-service test.**

### 5.1.7 Cycle weighting function

In this section we describe the weighting function for the final overall analysis of the bulldozer comparison. This analysis is based on measured activity data, Diesel Off-Road On-Line Registration System (DOORS) database, and stakeholder interviews such as local dealers and participants. The manufacturer was queried, but no information was provided. The purpose of this section is not to develop emissions inventory weighting factors, but to provide context to specify how the selected bulldozers are typically used and what fraction of bulldozers are represented by this power category. From this analysis, an overall emissions benefit was determined for the hybrids.

According to local Caterpillar dealers the most popular bulldozer are the D6 and D8. The D6 is mainly used by the housing industry and the D8 is mostly used by landfills. The larger dozers the D9, D10 and D11 are used in large quarries, dams, major road projects, and major industrial or housing building projects. As such, it is expected that the D7E will replace D6's for commercial projects and D8's for landfills.

According to a local dealer, more D7E's have been sold to landfills than to general construction projects. This agrees with UCR's deployment inventory. Of the 10 D7E distributed, as part of this project, seven of the bulldozers went to landfills and three when to public fleets for general earth moving projects (see Table 2-2). Interestingly, land fill operations put over 2000 hours in one year on their D7E where the public fleet operations put 700 hours of use on their D7E (see Table 6-1). This suggests landfills operate their equipment almost 3-times as much and probably also contribute more to local emission inventories. It is expected that general private fleet construction projects may utilize their equipment more than the public fleets, but it is expected landfill operation to still operate at higher runtime hours due to more consistent operations. (Landfills do not have a low usage season but general construction typically does.)

ARB has a database system that inventories off-road equipment in California. Figure 5-25 shows the percent fraction of selected Caterpillar bulldozers (also called crawler tractors) in CA according to the DOOR's database as of early 2013. Figure 5-25 shows that 32% of the Caterpillar bulldozers are D6's and 22% are D8's with about 9% D9's and 6% D7's. Caterpillar bulldozers represent 73% of the market where 44% of the bulldozers are either D6's, 7', 8's or 9's. Thus, the selected bulldozers presented in Figure 5-25 represent the majority of the market for bulldozers.

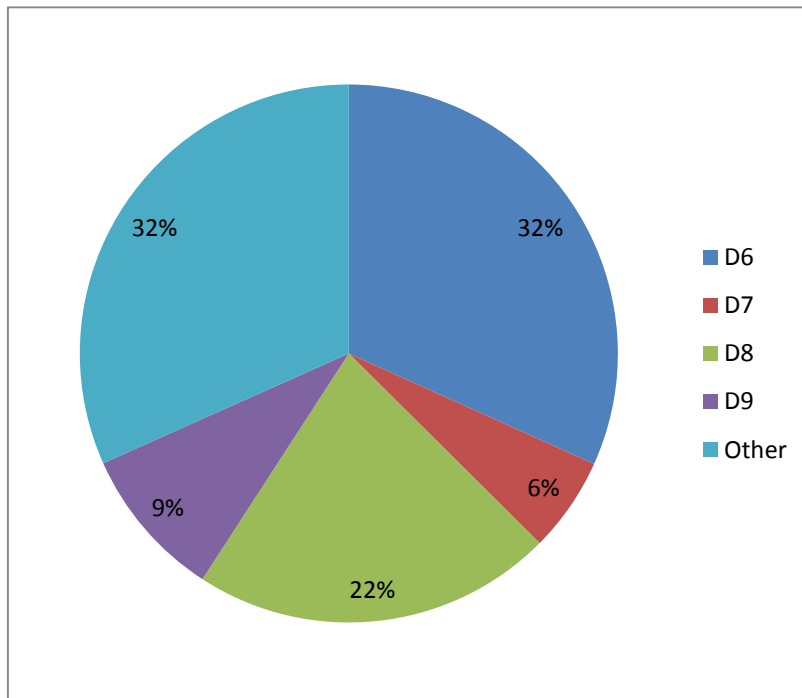


Figure 5-25 Percent fraction of selected bulldozers in CA, source DOORs YR2013

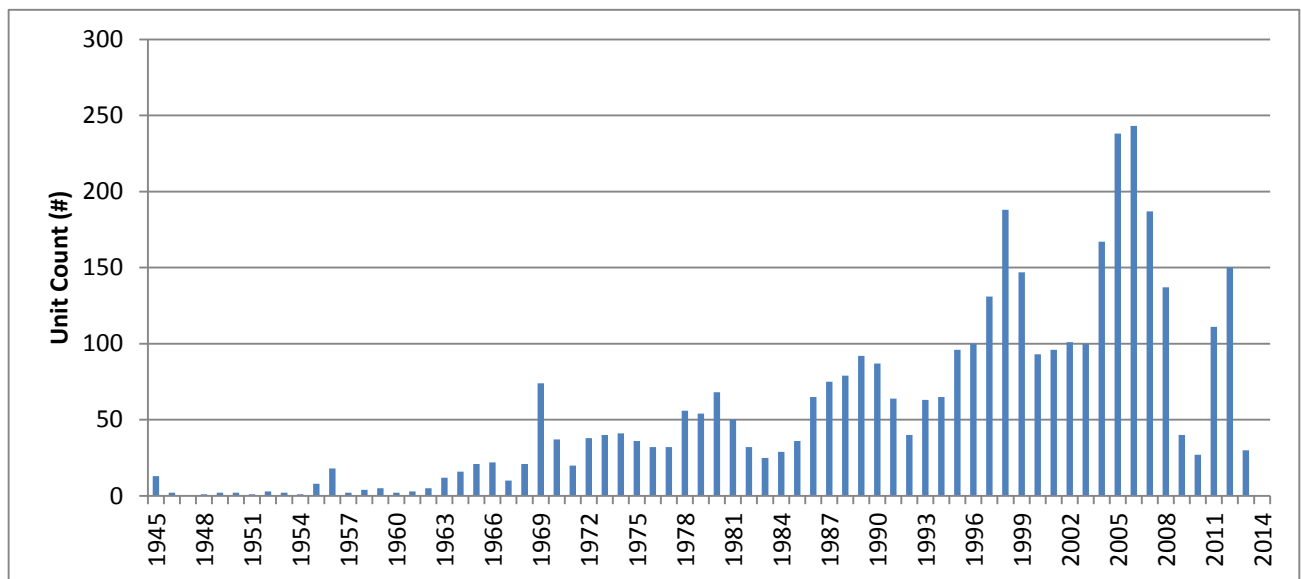


Figure 5-26 Age distribution of all bulldozers in CA, source DOORs YR2013

Figure 5-26 shows the age distribution of the bulldozers in the DOOR’s database. From Figure 5-26 you can see the age of the bulldozers goes back to 1945. The age fraction suggests there is a relatively large fraction of bulldozers older than 1985 in the CA fleet. Most fleets typically operate their newer equipment. If we remove the bulldozers older than 1985 the fractions in Figure 5-25 do not change significantly, thus the dozer size distributions appear to be independent of model year.

The inventory of bulldozers in CA suggests the D7E will be replacing either the D6 for general construction projects or the D8 for land fill operations. Given more D8’s are being replaced by D7E’s and more hours of use may be accumulated at landfills, the D7E and D8 comparison would be more appropriate for the impact the D7E will have in CA. Additionally, due to the much larger size

of the D8 in comparison to the D7E, the more technical comparison to the D7E is the D6T. As such, this report presents both comparisons, the D7E to the D6T and the D7E to the D8T.

The overall weighting function recommended is based on the 50<sup>th</sup> percentile push distance of 30 meters. The load recommended is based on the operation of the land fill where higher loads were found. It is expected higher loads are used (and fuel is burned) by the private sector than by the public sector. Thus, it is expected 90% of emissions come from high loaded tests and 10% come from light loaded tests.

Thus, the overall emissions benefit calculation is based on 80% full load tests at 30 meter push distances, 10% light load pushes at 30 meter distances, and 10% idle. The D6T represents the benefit expected for general construction operations and overall implementation of the hybrid system since the D6T is technically the most similar to the D7E. The D8T represents the benefits at landfill operations which represents a large fraction of the landfill bulldozers in CA. The D8R provides perspective on the benefit for replacement of non-ATS equipped engines. Given that the D6T is the most similar to the D7E, the main analysis is based on the D6T and not the D8T and D8R.

## **5.2 Komatsu excavator**

For the excavator the main work functions are digging and moving material. Typically the digging movement is a reciprocating operation that involves moving the bucket back and forth while swinging the upper structure of the machine around from side to side, not a pushing operation like the bulldozer. In addition to moving material, the excavators in this size range are multipurpose tools. They can be outfitted with many attachments, such as a hammer to break up concrete, a “thumb” for grabbing and lifting debris, and several other attachments. Komatsu developed a mechanism to take advantage of the rotational (swing) motion duty cycle that utilizes the hybrid storage and release power management system. Therefore, the hybrid may have less benefit relative to the conventional when using some of the excavator options such as the hammer attachment. The excavator duty cycle was developed around the activity measurements and historical records.

As previously described, excavators in the size range of the HB-215, the PC-220 and the PC-200 are used for many types of work, and at each work site they are often used for many different activities that require different attachments. For example, during this project on the Ft. Hunter Liggett construction site the excavators were routinely used to dig trenches (trenching), set pipe into the trench (craning), cover the pipe with dirt (back filling), and compacting the dirt over the pipe (compacting). Trenching and backfilling require the use of a bucket, craning does not require any attachment, and compacting requires the use of a compacting wheel. Since the excavators have a quick coupler on the end of their stick, these modes of work can all happen in fairly rapid succession, with very little pause in between.

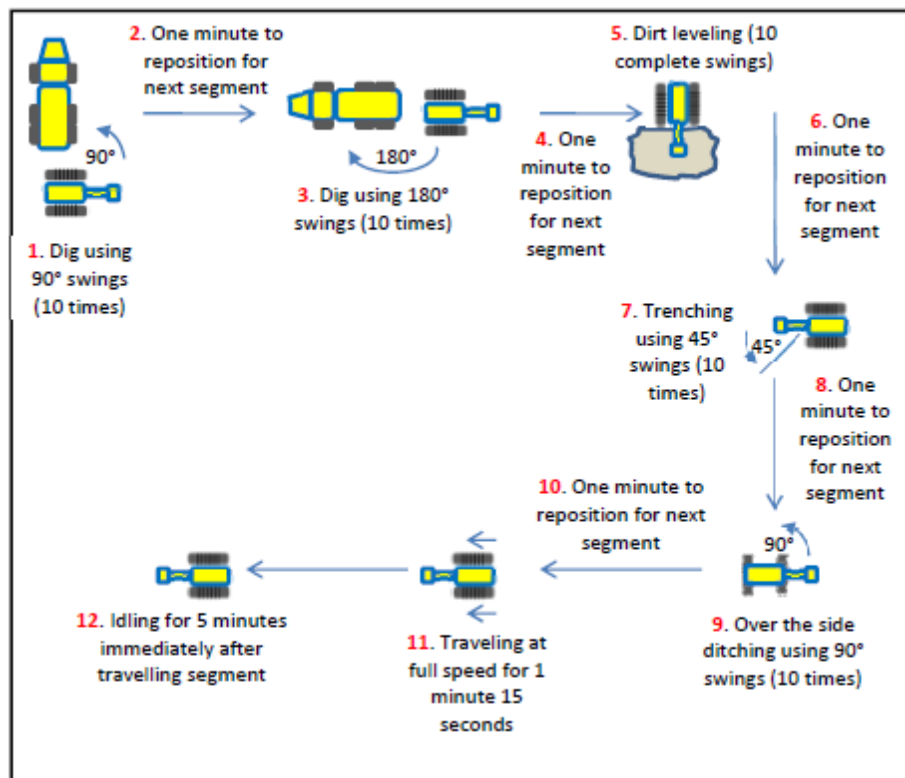
Since many of the modes these excavators are used for put different types of loads on the engine, they will influence emissions differently. So the task of building a representative duty cycle consists of evaluating key engine parameters that affect emissions for each mode as identified in the video data, then determining which of these modes are the most important overall, and which can be combined with others to simplify the final duty cycle to be used during emissions tests. When the final list of modes is decided upon, those can then be evaluated to determine how best to repeat them consistently in replicate runs of a test cycle and with different excavators.

The duty cycle development for the Komatsu HB215LC-1 excavator is based on measurements from RM, CE, and DD and upon interviews with experienced operators. The in-use data gave empirical information for the modes that were observed during the project and the interview data was more anecdotal. Since a few types of work that the experts agreed were common for excavators was not observed during the project, some modes were added to account for the expert options.

All three participants represent general engineering contract usage where RM and CE are equipment dealers who also rent their equipment to contractors and DD is a general contracting firm who owns a hybrid excavator and several conventional excavators and who also rents other excavators as needed. The excavators supported three types of projects: new bridge construction, demolition in preparation for a residential housing development, and construction of a wash facility for tactical vehicles at a military base. The in-service activity data was recorded with the same ECM and video tools as described in Section 4.2. This section describes the analysis of the data prepared for the Komatsu excavator duty cycle.

### 5.2.1 Komatsu excavator duty cycle

Komatsu has their own version of a test cycle they have used to evaluate different technologies and improvements in their systems. Figure 5-27 below shows the duty cycle used by Komatsu to compare between the hybrid and conventional excavators (presented at a PEMS conference hosted by CE-CERT in April 2012). This cycle was considered as we determined the modes we should define for the different types of excavator activity because it shows us what Komatsu believes to be important in evaluating the differences between the hybrid excavator and conventional excavators.



**Figure 5-27 Komatsu cycle used to evaluate between excavator technology improvements**

The Komatsu cycle includes several modes of digging (dig, trench and ditch) with various degrees of swing (45°, 90° and 180°), along with dirt leveling, traveling, and idling. Most of these modes were observed in the activity data collected during this project. Also, we know from interviews that these are all prominent and typical activities for excavators. However, these activities should probably not be equally weighted in a test cycle. Also, we have observed other activities that played prominent roles in work done during activity data collection and we know that other influences, not defined in the graphic, probably have significant impact on the fuel consumption and emissions rates. For example, the operator technique, the depth of the dig, the position of the boom and stick, and the rate of swing all are strong influences on power expended to accomplish a given task. So while the

Komatsu cycle as depicted in this graphic may provide a good starting point, there is probably considerable work that could be done to make it more representative.

### 5.2.1 UCR Analysis

The in-use activity data used to help develop the cycle were collected at a construction site at Ft. Hunter Liggett, southwest of King City, at a demolition site near Escondido, and at a construction site near Lancaster. Excavator work at the Ft. Hunter Liggett site consisted mainly of excavation and the installation of underground utilities such as drainage pipe and water pipe. The Escondido demolition site was in preparation for a new housing subdivision and had the excavators knocking down small structures (e.g., fences, agricultural buildings, small houses), sorting and piling the larger debris, and putting the sorted debris into bins and transfer trucks. The Lancaster site was excavating dirt and laying underground utilities to prepare for a new hospital that will be built on the same site.

The mode events were all manually identified while reviewing the video and entering the date and time of each. Then the mode event marker data were synchronized with the ECM and GPS data to allow a statistically based characterization of how each type of mode loaded the engine. The distribution of engine loads, duration of each event type, and other such parameters were determined to fully characterize each mode type and to combine modes that seemed different in the video data but turned out to have similar engine loading distributions. Once the modes were all characterized and consolidated as much as possible, a hypothetical duty cycle that mimicked the most prevalent modes in terms of engine load, duration, etc. was developed for emissions testing.

### 5.2.2 UCR Proposed duty cycle

Based on the consolidated modal data, supported with a statistical analysis of the logged activity data and with expert opinions from project participants, UCR developed a duty cycle that represents the operation of excavators approximately the same size as the Komatsu HB-215 and the PC-200. UCR recommends that the following metrics be targeted in the proposed cycle:

- travel/move
- idle
- dress
- trench with 45° swing
- backfill
- ditch with 90° swing
- dig with 180° swing

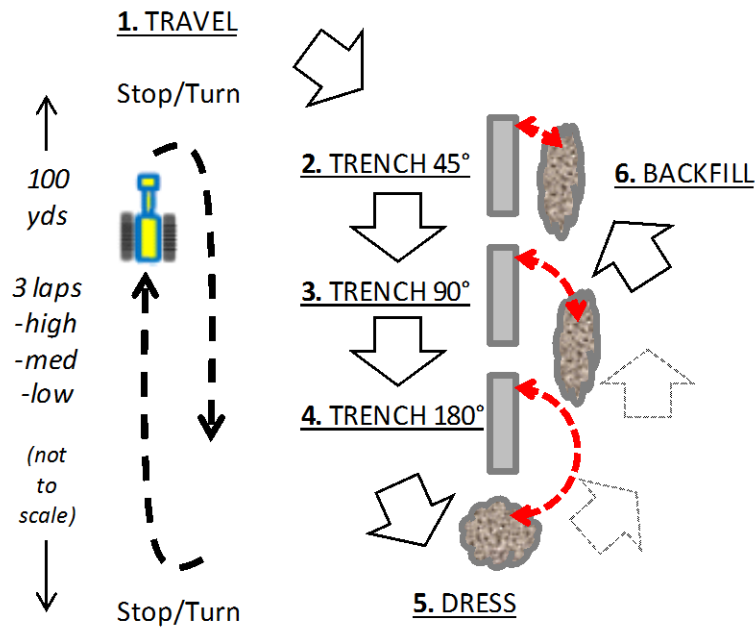
#### *Description of Test Cycle*

At the time this cycle was developed the overall, statewide weighting of these modes is not yet well-known. So the weighting of each mode in the final emissions result is likely to change from what has been concluded during this project. Therefore, after the emissions test cycle has been conducted, it is important that the emissions measurement results for each mode be easily separable from the others. To enable measurements to be done in a single session, yet be divided by mode during post-processing, a delay is inserted between each mode. The delay consists of unloaded idle time, with the engine running, so the “idle” mode is measured as the time between each of the other modes. Table 5-2 lists the sequence of events of the test cycle as they were conducted during emissions testing.

**Table 5-2 Excavator test cycle sequence**

<b>Cycle Mode</b>	<b>Description</b>	<b>Notes</b>
1	<b>Travel</b> in a predetermined 100-yd line, back and forth for about 3 laps. *Idle for 30-60 seconds. Cycle time = 10 min.	Speeds as allowed by the excavator (typical settings are “fast,” “medium,” and “slow”)
2	Trench over idler side of undercarriage ( <b>trench with 45°</b> swing) to single bucket width and 4 to 5 ft. depth for 8 minutes. *Idle for 30-60 seconds. Clean the topsides for safety as you go. Cycle time = 20 min.	Depth 4 – 5 ft and width 1 bucket
3	Stay over the idler side and ditch ( <b>trench with 90°</b> swing) to same depth with width for 8 minutes. *Idle for 30-60 seconds. Cycle time = 30 min.	Depth 4 – 5 ft and width 1 bucket
4	Stay over idlers and trench for 8 minutes ( <b>trench with 180°</b> swing) a pit of specified width and depth. *Idle for 3 minutes. Cycle time = 40 min.	Depth 4 – 5 ft and width 1 bucket
5	<b>Dress</b> the “trench 180” spoils into a level pile about 1 ft high until the entire pile is finished. Cycle time = 50 min.	Same mass as removed from “trench 180” (mode 4) hole. Volume adjusted from “bank” to “loose” value.
6	<b>Backfill</b> the spoils from the “trench 45” (mode 2) trench back into the same trench. Stop when it is filled level with the ground. Cycle time = 60 min.	Same dimensions as the “trench 45” (mode 2) trench with loose fill.
* A 7 <sup>th</sup> mode of “idle” was assembled during post processing from the pauses between test modes		

The entire cycle takes slightly longer than one hour. The travel or move mode 1 is 250 seconds long. The RPM and power is relatively constant as one would expect. The Trench 45 operation which is represented by mode 2 is 600 seconds long. This mode is transient and shows the engine swings from max load to less than 30% load frequently as a trench is dug and a 45 degree swing is performed. The next two modes “Trench 90” and “Trench 180” were not measured modes, but are known to be used in real practice and are similar to trenching, but with a longer rotational swing. These modes are critical for the evaluation of the hybrid system since the energy storage is optimized around the recovery of the rotational energy. The ditch and dig modes (A and B) were estimated from the measured trenching data. The dressing mode 5 represents an overall lighter engine work and less transient type operation where the excavator levels a pile of dirt using its bucket. The Backfill operation is represented by Mode 6 and like dressing involves a significant amount of swing with fairly light bucket loads. Figure 5-28 shows the cycle in graphical form.



**Figure 5-28 Sketch of excavator test cycle**

A single bucket was used for all modes and not other attachments are necessary for the actual testing (though some might be useful for preparing the area and cleaning it up afterward). The test area was prepared by first marking out where the travel mode would occur and determining where the rest of the modes would also occur. If necessary the operator would go through the cycle once to practice for the test. The tests were done in triplicate, digging in a new area each time. After some tests at a smaller site, the holes were re-filled and compacted to allow additional tests in the same spot.

The dimensions of the excavators and attachments have an important impact on engine loading. For example, if a given model PC200 is tested against another PC200, but one of them is using a much larger bucket than the other, then even though they are being tested under the same duty cycle, the loads on the two engines cannot be expected to be the same during testing. Since excavators in the size range of these units are sometimes ordered with options such as longer booms and sticks, then it is important to establish that all of the units tested of each model are representative of the most popularly sold options and are as similar to each other as possible. The same size of bucket was to be used when testing every excavator. When the PC-200 and the HB-215 excavators are tested, the same size boom, stick, quick-connect, and undercarriages should be used. Whenever the PC-220 model is tested, it should be confirmed beforehand that it also has the same size boom, stick, quick connect and undercarriage as each of the other PC-220 models tested. The relevant dimensions of each of these components on each excavator should be documented as they are tested.

#### *Test location and materials*

Test locations and materials can have an important impact on engine loads. If the terrain is uneven and unprepared, the effort required to travel (even on excavator tracks) can be significantly impacted. If the dug material is not homogeneous and fairly uniform from site to site, then the loads on excavators could be biased from site to site. The locations should be specified as a level area with enough room for the travel mode and with loam or some other consistent, homogeneous dirt with no large rocks and no underground utilities. The following list of features should be specified for finding appropriate test sites:



- The site should be a rectangle approximately 200 yards by 200 yards in area;
- The site should have homogeneous dirt that contains between 10% and 15% moisture down to about 8 feet deep and without rocks larger than gravel;
- The site should not have any underground utilities, and;
- The site should have an approximately level grade with a uniform surface appropriate for moving an excavator easily across.

### *Conducting the test*

After the test site was prepared and the operator had run through the test in a practice run, the trench ditch and pit was re-filled and compacted. Then the emissions test equipment was fully prepared and quality assured and the test could be conducted. Each test should be conducted in triplicate to follow good engineering practice and allow at least minimal statistical analysis of the differences between results. During testing two technicians should monitor the emissions equipment and the excavator to make sure the process is conducted as specified and the data is complete. Between test runs, the data should be field quality assured and the operator should be instructed on any minor deviations that may have occurred in their technique during the previous run. Enough time should be allowed for repeating any of the triplicate tests that were not conducted properly enough to give results comparable to the other two tests of the triplicate run.

#### *5.2.3 Evaluation of proposed duty cycle*

UCR specified that each test be evaluated for distance, speed, fuel consumption and average power. It was expected that there would be more variability than laboratory testing where 1-2% coefficient of variation (COV) is expected for fuel consumption (chassis or engine dynamometer). Others have found in-use repeatability for off-road test cycle to be with-in 7% for fuel consumption when using non 1065 approved PEMS [7]. These metrics will be used to evaluate the test cycles after each test.

To correct for variability between replicate tests, we investigated the possibility of “correcting” the modal emissions to a standard mode length. For example some modes are specified to last 8 minutes, but if in one replicate the mode lasts 7.5 minutes and in another it lasts 8.5 minutes, it may be possible to adjust the total emissions to what they would have been had the replicate modes all lasted exactly the specified length of time.

Other corrections to test and additional tests were performed for those that were outliers. Testing standard operating procedures (SOP’s) provide more detail regarding UCR’s approach for data checks and testing practices (see Appendix E).

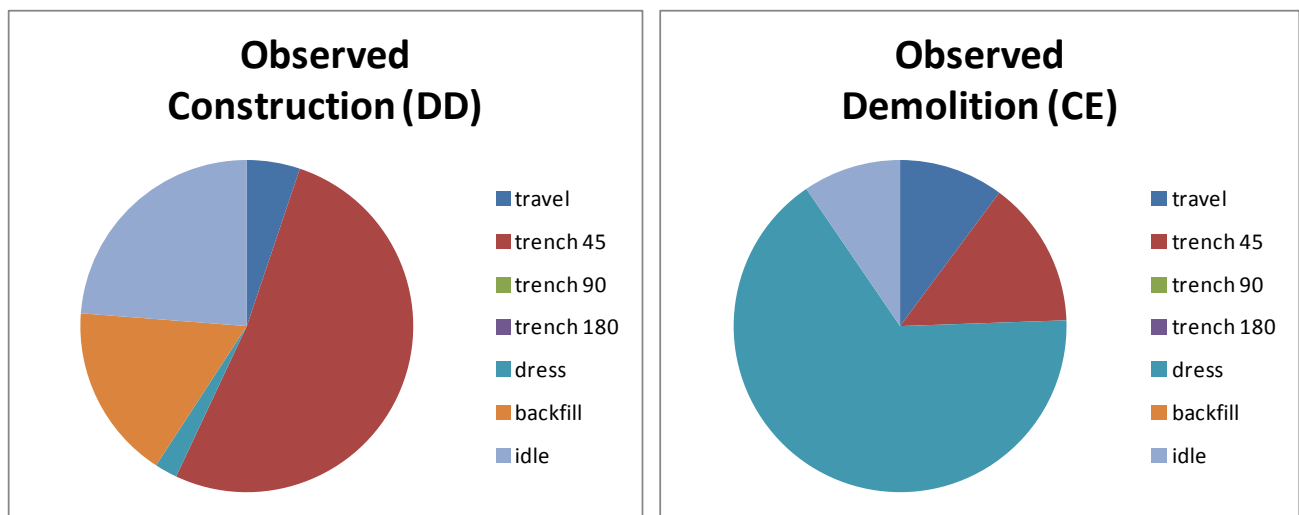
#### *5.2.4 Cycle weighting function*

In this section we describe the weighting function for the final overall analysis of the excavator comparison. This is the weighting to use when calculating a representative average emission rate for typical excavator operation in California. This analysis is based on measured activity data, ARB’s DOORS database, and stakeholder interviews such as local dealers, project participants, and the manufacturer. It should be considered a preliminary suggestion based upon a rather small data set. It can almost certainly be improved through collection and analysis of additional activity data and additional expert excavator owner opinion. The purpose of this section is not to develop emissions inventory weighting factors, but to provide context to specify how the selected excavators are typically used and what fraction of excavators are represented by this power category. From this analysis, an overall emissions benefit was determined for the hybrids.

After having consolidated similar modes into seven that cover the full range of operations, we analyzed the activity data to determine what fraction of engine time is spent in each of the final modes as compared to the total engine time of operation, as shown in Table 5-3 and Figure 5-29.

**Table 5-3 Calculation of observed weighting mode fractions**

Mode No	Mode Name	Observed Construction (DD)		Observed Demolition (CE)	
		Total Engine Hours	% of Total	Total Engine Hours	% of Total
1	travel	4	5.2%	3.2	10.2%
2	trench 45	40.1	51.8%	4.5	14.3%
3	trench 90	0	0.0%	0	0.0%
4	trench 180	0	0.0%	0	0.0%
5	dress	1.7	2.2%	20.8	66.0%
6	backfill	13.2	17.1%	0	0.0%
7	idle	18.4	23.8%	3	9.5%
		77.4	100%	31.5	100%



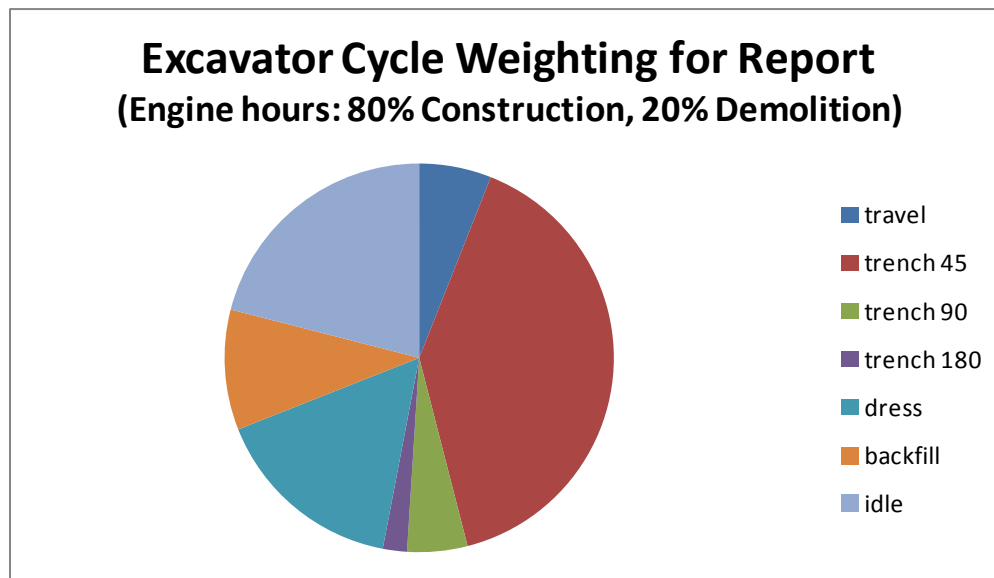
**Figure 5-29 Observed construction and demolition mode fractions**

By combining the observed modal fractions we can calculate a statewide estimate of how this class of excavator is typically used. This requires an assumption of the statewide average of the type of work done by these excavators as a fraction of engine-on time. In talking to the participants in the project and the manufacturer of the excavators, we arrived at an estimate of about 20% of engine time is for demolition type of work and the rest is for construction. The estimates of the fraction of calendar time for these types of operations was closer to 10% demolition, but we observed in the activity data that a much larger fraction of the work day was spent with the engine on for demolition projects than for construction projects. This resulted in our increasing the fraction for engine-on time to 20% demolition. The resulting calculations and results are shown below in Table 5-4 and in Figure 5-30.

**Table 5-4 Assumptions and calculation of state-wide mode fractions**

Mode No	Mode Name	<sup>1</sup> Job Type Wtd Avg	Proposed Cycle Engine Time Weighting
1	travel	6.2%	6%
2	trench 45	44.3%	40%
3	trench 90	0.0%	5%
4	trench 180	0.0%	2%
5	dress	15.0%	16%
6	backfill	13.6%	10%
7	idle	20.9%	21%
		100%	100%

<sup>1</sup>Assumes 80%/20% engine hour split for construction/demolition




**Figure 5-30 Estimated state-wide mode fractions**

According to Komatsu the excavators in the weight range around that of the HB-215 are considered in the industry to be “the Swiss Army Knife” of excavators. Like other excavators they can be used for many types of work in their stock configuration. But unlike smaller classes, they are large enough to be effective in general commercial construction projects. Also, unlike larger classes, many attachments exist to expand their capabilities to work such as drilling, hammering compacting, and many other uses.

The selection of other manufacturer’s models in competition with the HB215 is large. Table 5-5 below lists models from other major manufacturers that Komatsu compares to the HB215. According to the DOORS database, as of 2010, there are 11,823 excavators in California with model years ranging from 2008 to 1945. The manufacturers include Caterpillar (42%), Komatsu (10%), Deere (9%), Hitachi (8%), with the remaining 31% distributed amongst many manufacturers. Of these excavators, slightly less than 10% (1,622) have horsepower in the range of 150 to 200. This is the group of excavators that are most likely in competition with the HB215. The distribution by manufacturers in this horsepower range is shown in Figure 5-31, where it can be seen that the

Komatsu PC200 and Komatsu PC220 account for 7%. While Komatsu compares the HB215LC-1 hybrid with the PC200, users have indicated they would consider replacing the PC220 with the HB215LC-1 hybrid. There are 3.4 times as many PC220's as there are PC200's so emission comparisons were made between the PC220 as well as the PC200.

**Table 5-5 Excavators Competing with the HB215**

						
Model	Komatsu HB215LC-1	Komatsu PC200LC-8	Caterpillar 320D L	Volvo EC210C LC	Kobelco SK210LC Acera Mark 8	Hitachi ZX200LC-3
<b>General</b>						
Brand	Komatsu	Komatsu	Caterpillar	Volvo	Kobelco	Hitachi
Model	HB215LC-1	PC200LC-8	320D L	EC210C LC	SK210LC Acera Mark 8	ZX200LC-3
Arm Selection (m)	2.9	2.9	2.9 m Arm Length	2.9 m Arm Length	2.9 m Arm Length	2.9 m Arm Length
<b>Weight</b>						
Operating Weight (kg)	21850	21437	21570	22000	21700	22673
Counterweight Mass (kg)	np	3730	3860	4200	4639	4750
Ground Pressure (kg / cm <sup>2</sup> )	0.35	0.38	n/p	0.31	0.344	0.372
<b>Engine</b>						
Engine Make	KOMATSU	KOMATSU	CAT	VOLVO	IVECO	ISUZU
Engine Model	SAA4D107E-1-A	SAA6D107E-1	C6.4 ACERT	D6E EAE3	F4GE9684E-J6	AH-4HK1.XYSA-01
Net Horsepower (kW)	104	110	110	110	112	118
Number of Cylinders	4	6	6	6	6	4
Piston Displacement (ltr)	4.5	6.7	6.4	5.7	6.7	5.193
Emission Certification	Tier 3	Tier 3	Tier 3	Tier 3	Tier 3	Tier 3
<b>Hydraulics</b>						
Max. Flow (ltr/min)	439	439	410	400	440	424
<b>Undercarriage</b>						
Max. Drawbar Pull (kg)	18200	18200	20904	18661	23352	20711
Max. Travel Speed: High (KPH)	5.5	5.5	5.5	5.5	6	5.5
<b>Swing</b>						
Swing Speed (rpm)	12.4	12.4	11.5	11.6	12.5	13.3
Swing Torque (kg-m)		6900	6302	7811	7291	7026
<b>Performance</b>						
Bucket Capacity - 1660 kg Material Loose (m <sup>3</sup> )	1.2	1.2	1.4	1.35	1.37	1.05
<b>Dimensions</b>						
Overall Height to Top of Cab (mm)	3040	3040	2950	2930	2930	2950
Swing Radius (mm)	2750	2750	2750	2850	2750	2750
Track Length (mm)	4450	4450	4455	4460	4450	4460
Track Gauge (mm)	2380	2380	2380	2390	2390	2390
Overall Length (mm)	9425	9425	9460	9690	9450	9530
Overall Width (mm)	3180	3180	3080	3190	3190	3190
Ground Clearance (Minimum) (mm)	440	440	450	460	450	450
Width of Crawler (mm)	3180	3180	3080	3190	3190	3190
Shoe Width (mm)	800	800	800	800	800	800

<sup>1</sup> Source: Komatsu's web site

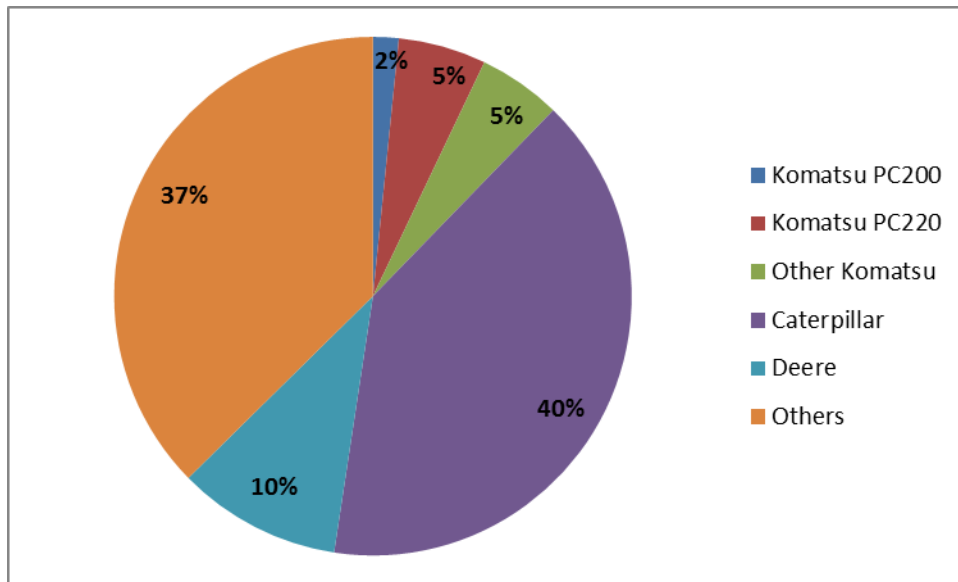


Figure 5-31 Percentage of Excavators in the 150 to 200 hp range (source DOORS YR2010)

## 6 Emission Results

The results of the emissions and fuel consumption testing are summarized and discussed in this section. The section discusses separately the Caterpillar bulldozer and the Komatsu excavators. For each of the equipment types, the results are discussed separately for the different types of testing done. The units for comparing the emissions and fuel consumption depended on the specific type of testing that was being conducted. For the tests that were more controlled, where a specific amount of material was being moved as part of a prescribed testing protocol, the results for the different emissions components are evaluated in terms of g/hr and g/ton of material moved during the different test cycles. Since the amount of material moved during the in-revenue-service varies depending on the specific unit being tested and specific task for a given test day and cannot be readily measured, comparisons between units were not done on a g/ton of material basis for the in-use and in-revenue service testing. The in-service and in-revenue service results are presented in terms of g/hp-hr and g/kg fuel, see Section 5.1.6 for details.

The main point of this hybrid deployment and evaluation pilot project is to evaluate benefits due to the hybrid system. Benefits due to unit size, aftertreatment system, tier level, and unit capacity should not be the significant factors in the comparison. Unfortunately there are no direct like-comparisons so one must consider the intended industry the unit is being deployed for and its benefit in that application also. Thus the analysis should first consider the benefit from the hybridization and then its implementation of the hybridization as it relates to the penetration into each market category. The approach for the analysis presented in the following sections is first based on the hybridization then the equivalent replacement.

In summary, the main overall hybrid bulldozer evaluation is primarily based on the D6T. Additionally the D8T and D8R were considered. Their evaluation was less robust compared to the evaluation of the D6T due to comparable sizes and push capabilities. Also, the main comparison for the excavators is between the hybrid HB215 and the conventional PC200, which the manufacturer considers the closest comparison that can be drawn from their fleet.

### 6.1 Caterpillar bulldozers

The Caterpillar bulldozers were tested over controlled push tests, controlled in service tests, and in-service tests. Comparisons are made between the D7E hybrid bulldozers and the D6T, D8T, and D8R conventional bulldozers. Table 6-1 shows a list of hybrid and conventional bulldozers in the size category tested. The D7E, D6T, and D8T were Tier 4 interim units with DPF equipped engines and the D8R was a Tier 3 as listed in Table 6-1. As discussed in Section 5.1.6, the duty cycle developed includes controlled push, controlled in-service, and in-service testing. The different emissions for the controlled tests results are presented in terms of g/hr and g/ton of material moved during the different test cycles. The in-service results are presented in terms of g/hp-hr and g/kg-fuel. Appendix I has all the results for each of the duty cycles on all basis's which include g/hr, g/kg-fuel, g/hp-h, and g/ton (where practical). There are no g/ton emission results for the in-revenue service testing since the tons moved were not quantified.

**Table 6-1 Hybrid and conventional bulldozers tested as part of this evaluation**

ID #	Unit Model n/a	Facility <sup>2</sup> n/a	Eng Model n/a	Disp liters	Year n/a	Eng Hr <sup>1</sup> hr	Gross Power <sup>3</sup> Hp	Rated Torque <sup>3</sup> ft-lb	Lug Curve <sup>3</sup> n/a	ATS n/a		
1	D8R T2	WM	3406E	14.6	2003	17149	348	1800	1200	1300	actual	n/a
2	D6T T4i	John Mach	ACERT C9.3	9.3	2012	24	229	1850	1021	1300	est	DOC/DPF
3	D8T T4i	John Mach	ACERT C15	15.2	2012	32 & 600 <sup>4</sup>	348	1850	1446	1300	est	DOC/DPF
4	D7E T4i	WM	ACERT 9.3	9.3	2011	2528	252	1700	1047	1600	est	DOC/DPF
5	D7E T4i	OC	ACERT 9.3	9.3	2011	573	252	1700	1047	1600	est	DOC/DPF

<sup>1</sup> Nominal hours during testing (varies by day used)

<sup>2</sup> Owner is the equipment owner. JM is Johnson Machinery WM is Waste Management, OC is Orange County Water District.

<sup>3</sup> Rated conditions from CAT ET download, gross from published materials.

<sup>4</sup> D8T T4i retest 01/08/13, 600 engine hours on since last tested.

### 6.1.1 Analysis

The emission results are primarily based on emissions per ton and emissions per hour. The controlled pull and push tests were analyzed as described in the duty-cycle development Section 5.1.5 of this report. The in-service tests are based on grams of emissions divided by the work of the engine. The engine work was determined from ECM percent load and estimated lug curves for each engine. Official lug curves were not provided from the manufacturer so estimated ones were used. A copy of the lug curves are provided in Appendix I.

The overall hybrid benefit is derived from the g/hr and g/tons comparison testing. The in-service testing was performed to validate the controlled testing. Thus the in-service tests are presented on a g/hp-hr and g/kg-fuel basis. The full results are available in Appendix A. The main comparison to the D7E-T4i is the D6T-T4i since technically the D6T is closest in size and power to the D7E. Since many conventional D8's are being replaced by D7E's comparison of the D7E with the D8T are also included. Additionally, to understand the benefit of replacing older units, the D8R was tested. The D8R results are only provided on a g/hp-hr and g/kg-fuel basis.

### 6.1.2 D7E-T4i vs D6T-T4i Results

This section is broken into three sub sections, 1) controlled pull tests, 2) controlled in-use tests, 3) and in-service tests. The controlled pull test represents the main basis for the overall comparison, the controlled in-use tests reveal issues between unit sizes, and the in-service tests provide support that the controlled pull testing was performed with reasonable equipment loads and usage.

#### Controlled pull tests

The CO<sub>2</sub> results for the controlled pull tests are presented in Figure 6-1 on a g/hr and a g/ton basis. For each testing mode, as well as the idle modes, comparisons are made between the hybrid and conventional bulldozer. For the controlled pull tests, the tests are done in terms of the distance the material is being pulled (i.e., 10 m, 30 m, and 80 m) and the amount of material in the bin being pulled (i.e., 0.5, 2, and 3). The right y-axis shows the results in terms of percent difference for the hybrid vs. conventional bulldozer. The error bars represent 90<sup>th</sup> percent confidence intervals about the mean measurement for each mode tested.

Overall, the results show a hybrid benefit ranging from approximately 10 to 30% for the hybrid bulldozer for nearly all of the controlled tests and they are statistically different at 90% confidence except for high idle. The benefit for the hybrid bulldozer is more significant for the lower weight bins and for the shorter pull distances. For the high and low idle emissions, there was about a 15 to

18% benefit in the hybrid bulldozer, although the difference between the low idle emissions for the hybrid and conventional bulldozers was comparable within the experimental variability.

Interestingly, the results on a g/ton of material basis show similar trends to those on a g/hr basis, but the benefits for the hybrid are not as great as those for a g/hr basis. The load cell shows the load was slightly higher for the D6T compared to the D7E. Thus, at least part of the reason the g/ton emissions are lower than the g/hr is based on the fact the D6T was subjected to slightly higher pull loads as measured by the load cell.



**Figure 6-1 CO<sub>2</sub> Emissions on a g/hr and g/ton basis for the different controlled push tests D6T.**

The NO<sub>x</sub> results for the controlled pull are presented in Figure 6-2 on a g/hr and a g/ton basis. The NO<sub>x</sub> results show higher emissions for the hybrid under nearly all test conditions. The NO<sub>x</sub> increases



ranged up to 17% on a g/hr basis and up to 31% on a g/ton basis. The increases in NO<sub>x</sub> for the hybrid equipment may be due to the calibration of the engine in terms of different duty cycles. Additional discussion about the NO<sub>x</sub> dis-benefit is presented in the in-service section on a brake-specific basis.

The NO<sub>x</sub> increases are higher for the heavier bin than the lighter bin. For the lighter bin, the NO<sub>x</sub> increases were statistically different for the 80 meter distance and for the 30 meter distance on a g/ton basis, but the results were not statistically different for the 10 meter distance and the 30 meter distance on a g/hr basis. The idle results showed mixed results, with a NO<sub>x</sub> increase for the hybrid bulldozer for the high idle and NO<sub>x</sub> decrease for the hybrid bulldozer for the low idle. The hybrid high idle is at a higher engine speed compared to the conventional thus the hybrid is under slightly higher load and thus higher emission rates would be expected on a g/hr basis.

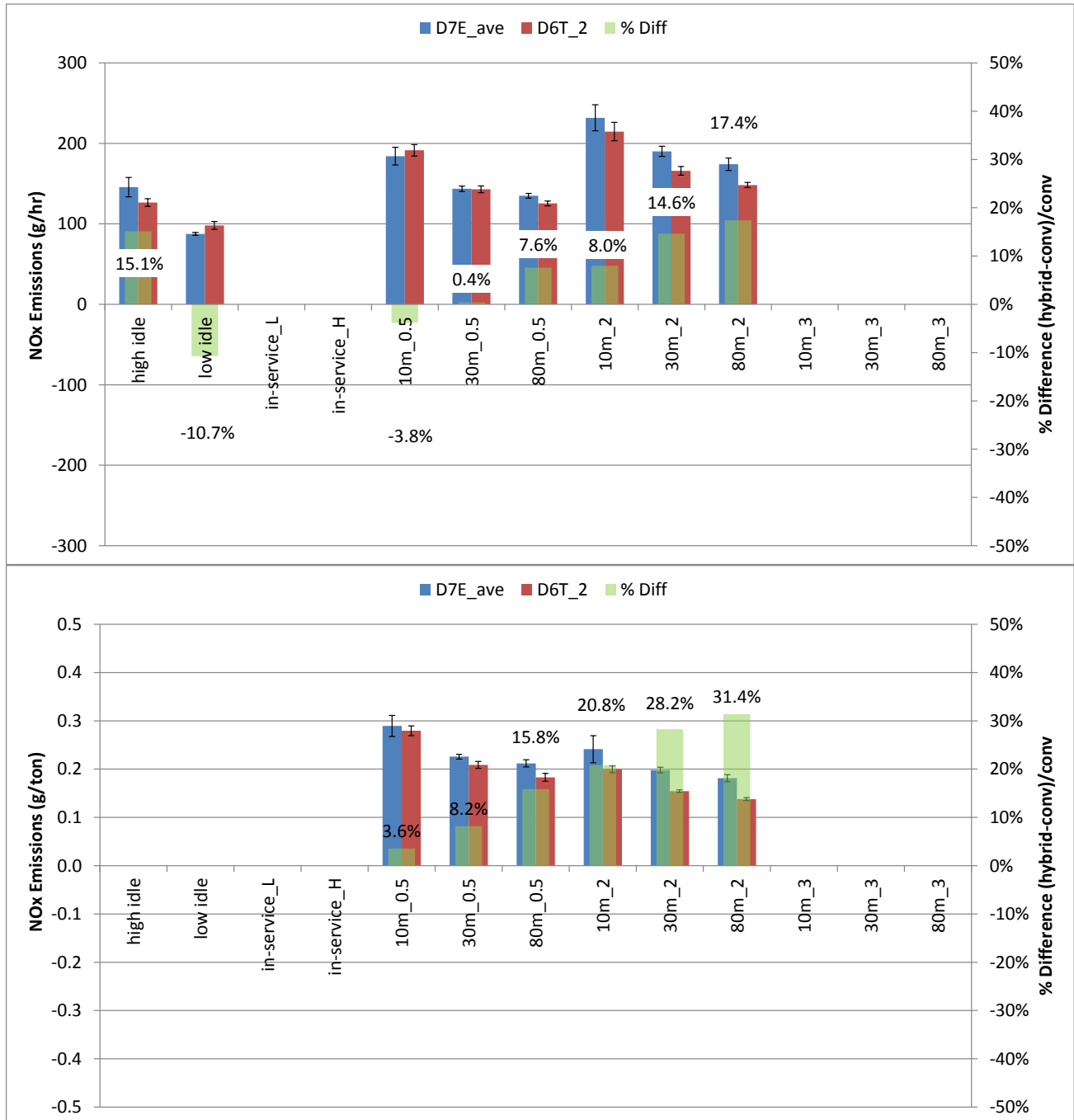


Figure 6-2 NO<sub>x</sub> Emissions on a g/hr and g/ton basis for the different controlled push tests.

The PM results for the controlled pull are presented in Figure 6-3 on a g/hr and a g/ton basis. The PM emissions are relatively low, since these units are equipped with DPFs. As such, the percentage differences for the PM emissions are quantified in terms of the percentage difference relative to what the PM standard (PM std = 0.015 g/hp-h) might represent on a g/hr basis. For these values, PM emissions standards in g/hp-hr were converted to a g/hr basis using a 40% certification load level. The results show measurable reductions in PM emissions for the hybrid equipment. These reductions represent 1.8% or less of the standard.

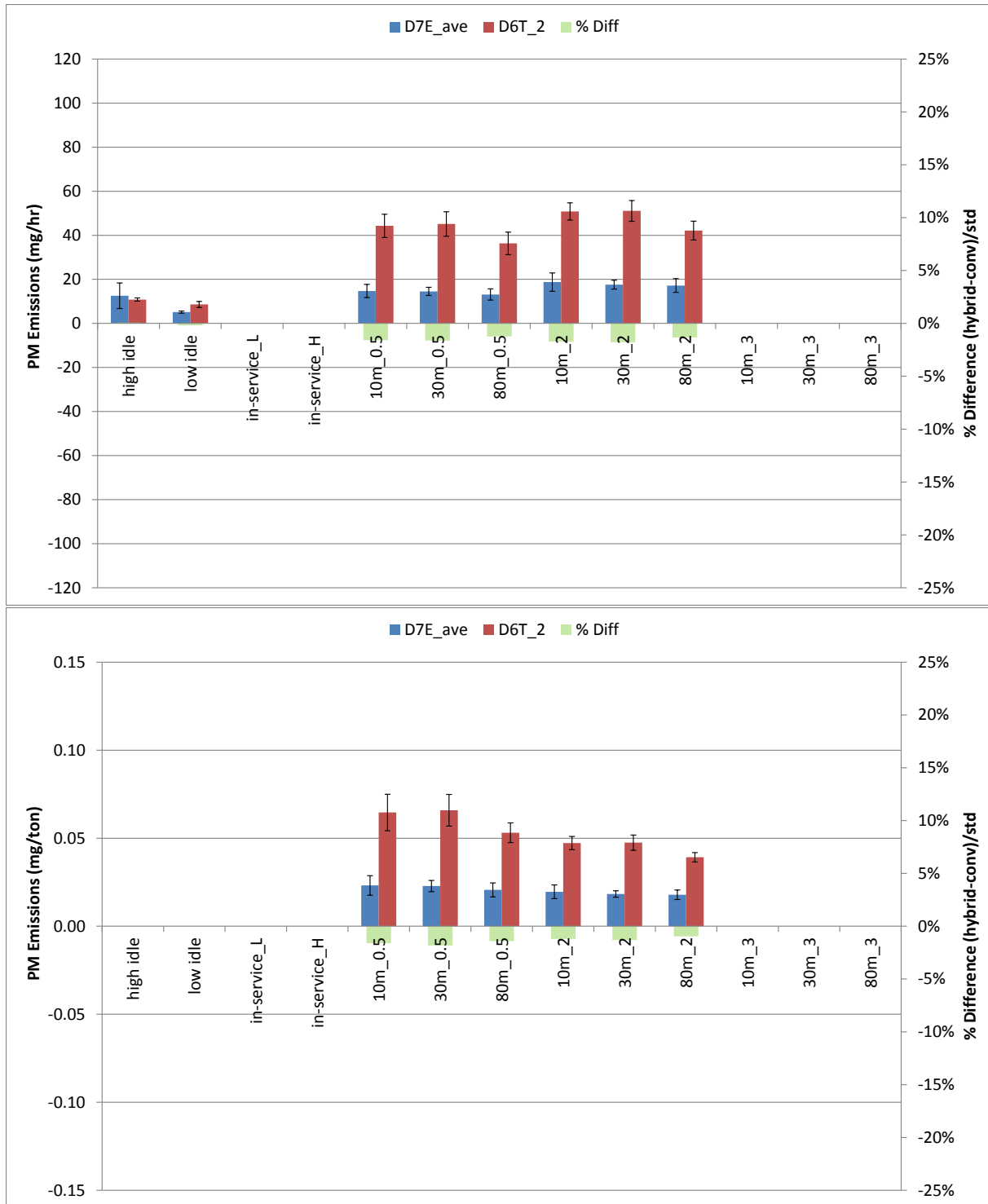


Figure 6-3 PM Emissions on a g/hr and g/ton basis for the different controlled push tests.

The CO results for the controlled pull are presented in Figure 6-4 on a g/hr and a g/ton basis. The CO emissions are also relatively low, due to the DOC/DPFs. Again, the percentage differences for the CO emissions are quantified in terms of the percentage difference relatively to the CO standard converted to a g/hr (CO std = 2.6 g/hp-h) basis using a 40% load level. The results show measurable increases in CO emissions for the hybrid equipment, but these increases represent 2.8% or less of the standard on a g/hr basis and 2.2% or less of the standard on a g/ton basis. Additionally the CO measurements were less than zero and represent concentrations below the drift specification of the PEMS instrument.

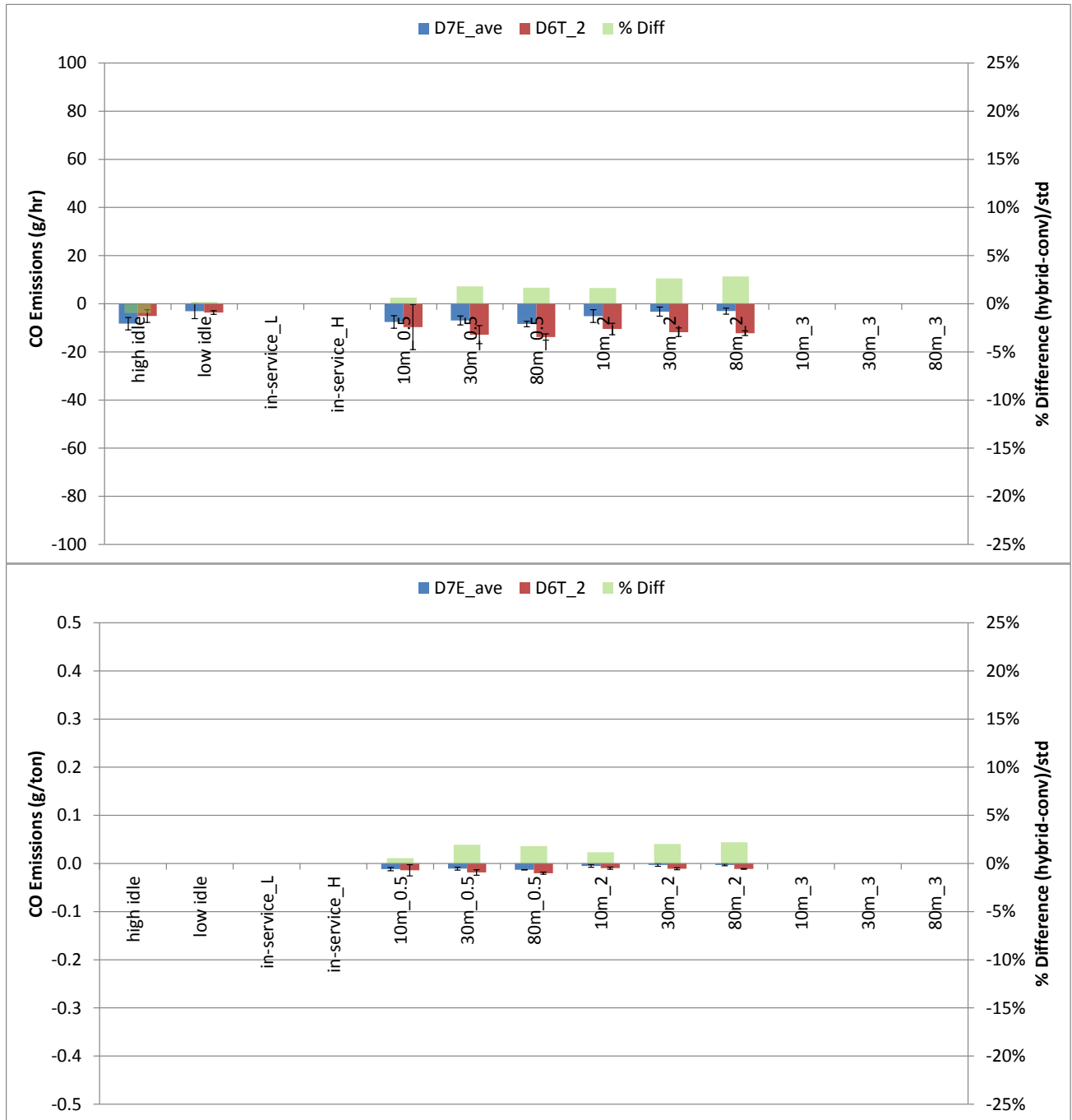


Figure 6-4 CO Emissions on a g/hr and g/ton basis for the different controlled push tests.

The THC results for the controlled pull are presented in Figure 6-4 on a g/hr and a g/ton basis. The THC emissions are also relatively low, due to the DOC/DPFs. The percentage differences for the THC emissions are quantified in terms of the percentage difference relative to the THC standard converted to a g/hr (THC est = 0.5 g/hp-h) basis using a 40% load level. The results show measurable increases in THC emissions for the hybrid equipment, but these increases represent 2.4% or less of the estimated standard on a g/hr basis and 3.4% or less of the estimated standard on a g/ton basis. Many of the error bars overlap suggesting the mean differences are not statistical significant at 90% confidence.

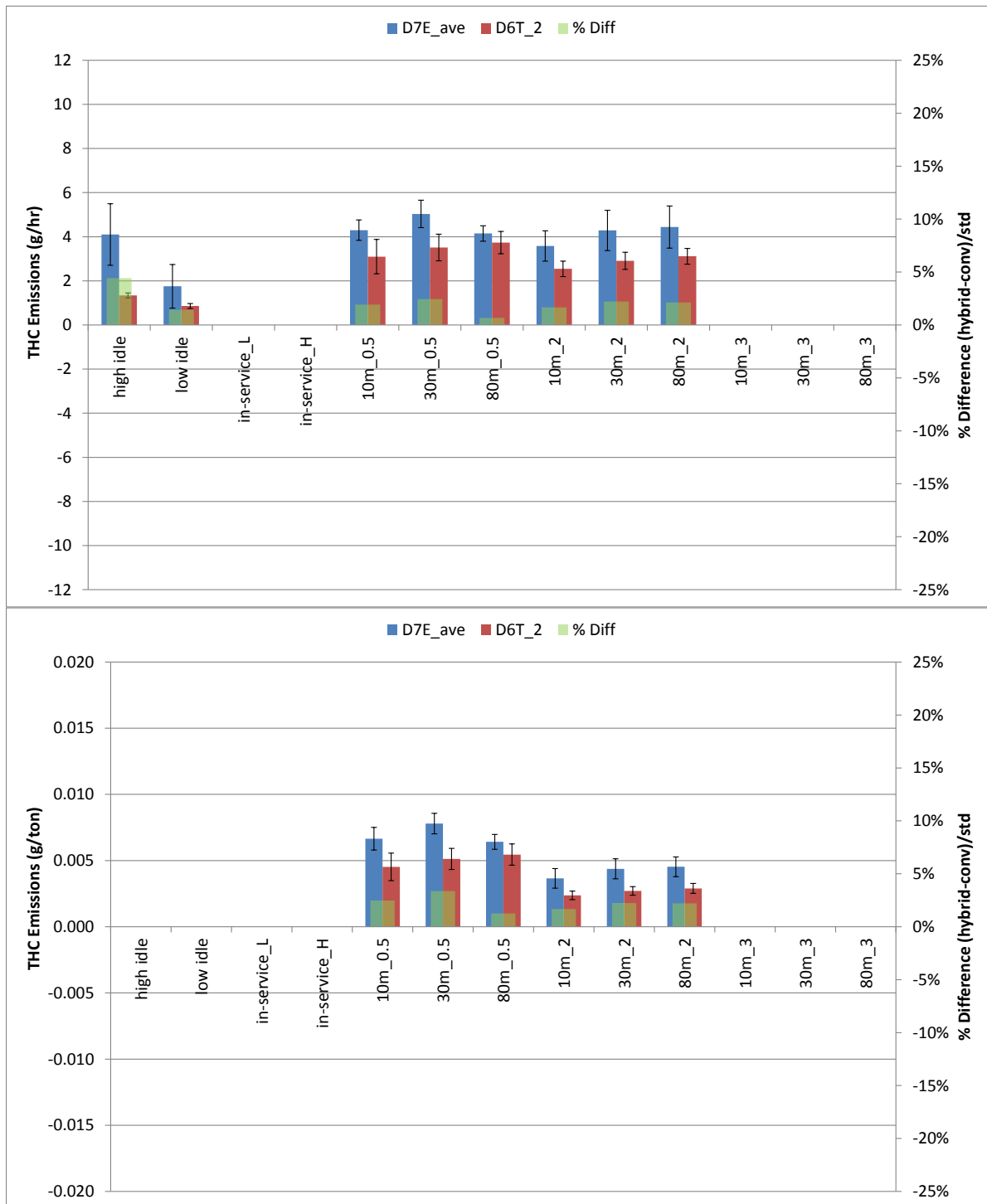


Figure 6-5 THC Emissions on a g/hr and g/ton basis for the different controlled push tests.

### *Controlled in-use tests*

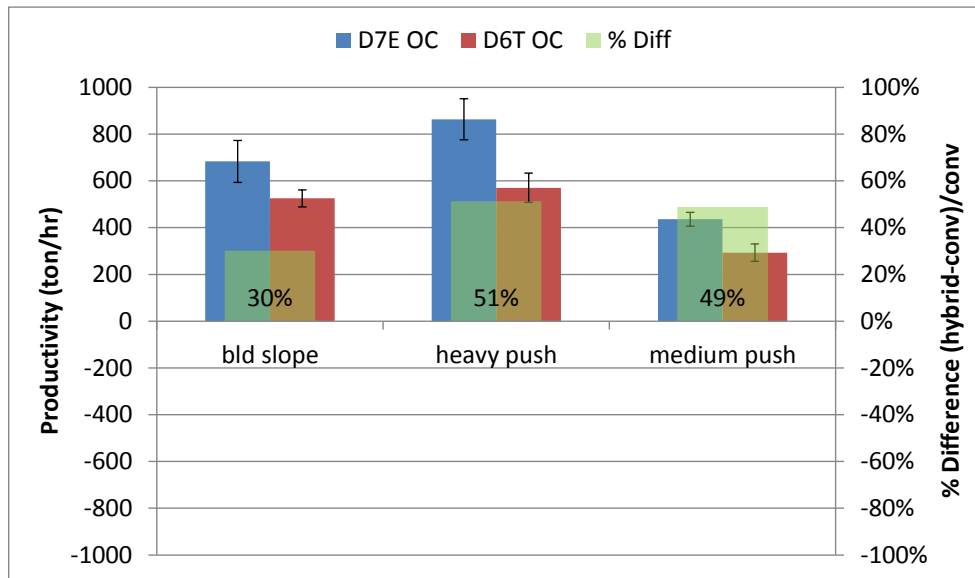
As discussed previously the main point of this hybrid demonstration project is to evaluate the benefits due to the hybrid system and not due to differences in non-hybrid system performances. Secondly the purpose is to consider the replacement of the conventional with the hybrid where other performance differences would be evaluated.

To make a fair in-use comparison one needs to compare like machines with identical capabilities. In this section, UCR evaluated two bulldozer's true in-service performance by moving earth. The D6T and D7E had the same C9.3 ACERT engine but were different in almost every other way. The D6T was equipped with 10.8 foot wide SU XL blade with a side extension made for more generalized application and was equipped with high track with lifted sprocket for better ground clearance. The OC D7E is an OC owned unit equipped with 15.2 foot wide variable radius blade custom made by Balderson Blade Co. The extra wide blade is specially fit for OC's day to day activity and is about 40% larger than the D6T equipped blade. The OC D7E is also a LGP model with extra wide track for work in the river where the D6T has the standard track widths.

Since the OC D7E's larger blade is tailored to the in-service work, we expect the D7E to be more productive than the D6T. Figure 6-6 shows the performance of the D6T and D7E on a tons/hr basis for three different modes. For each testing mode, comparisons are made between the hybrid and conventional bulldozer. The modes include pushing up a grade, and excavating a 50 by 50 foot pad at two different cut depths, see Section 5.1.6 for details. The right y-axis shows the results in terms of percent difference for the hybrid vs. conventional bulldozer. The error bars represent a single standard deviation.

The figure shows that the D7E is about 30% to 50% more productive in term of tons of material moved per hour than the D6T where the two pad excavations showed the highest benefits compared to the slope building. The average load on the slope building was ~143 hp and ~175 hp for the heavy pad excavation. Again, this large benefit is not all due to the hybrid power train but rather a combined contribution from larger machine size, larger application specific blade (40% larger), and more experienced D7E operator compared to the D6T rented unit. We did note that the D7E had a faster 1<sup>st</sup> full blade push speed compared to the D6T with an average about 20% faster speed of 2.9 km/hr versus 2.4 km/hr, respectively. The power during these 1<sup>st</sup> pushes was 244 hp and 209 hp for the D7E and D6T, respectively.

The higher performance of the D7E over the D6T suggests the emissions will also show a higher benefit. Some of this benefit will be a result of the blade and track details and some of the benefit will be due to the hybrids higher traveling velocity. Thus, these emission differences need to be considered within this context.



**Figure 6-6 Controlled in-use testing performance ton/hr D7E vs D6T.**

The CO<sub>2</sub> results for the controlled in-use testing are presented in Figure 6-7 on a g/ton basis. Overall, the results show a hybrid benefit ranging from approximately 33 to 44% for the bulldozer for all of the in-use controlled tests. The benefit for the hybrid bulldozer is more significant for the lower cut excavation than the heavy cut excavation which agrees with that presented earlier for the pull tests. Interestingly the grade building test showed the largest hybrid benefit. The average power for the D7E for the building slope tests was 143 hp whereas it averaged 153 hp for the heavy excavation and 122 hp for the light excavation.

The NO<sub>x</sub> results for the controlled in-use testing are presented in Figure 6-8 on a g/ton basis. Overall, the results show a hybrid benefit ranging from approximately 8 to 16% for the bulldozer for all of the in-use controlled tests. The PM, CO, and THC emissions were all low and similar to the pull tests and are thus not presented. For more details on these results see Appendix I.

Interestingly these tests showed the only positive NO<sub>x</sub> benefit for the hybrid D7E over the D6T bulldozer. The statistical significance of the difference between the means is low, but this is the first trend we have seen where the NO<sub>x</sub> is lower for the hybrid over the conventional D6T. The fuel consumption benefit is almost twice that of the pull tests which ranged from 10 to 30%. Thus, this suggests some of the benefit is due to the blade size (40% larger) and some due to the hybrid (20% faster). The next section considers the load specific emissions to see what is happening on a work basis to help quantify the hybrid benefit during these in-use controlled tests.

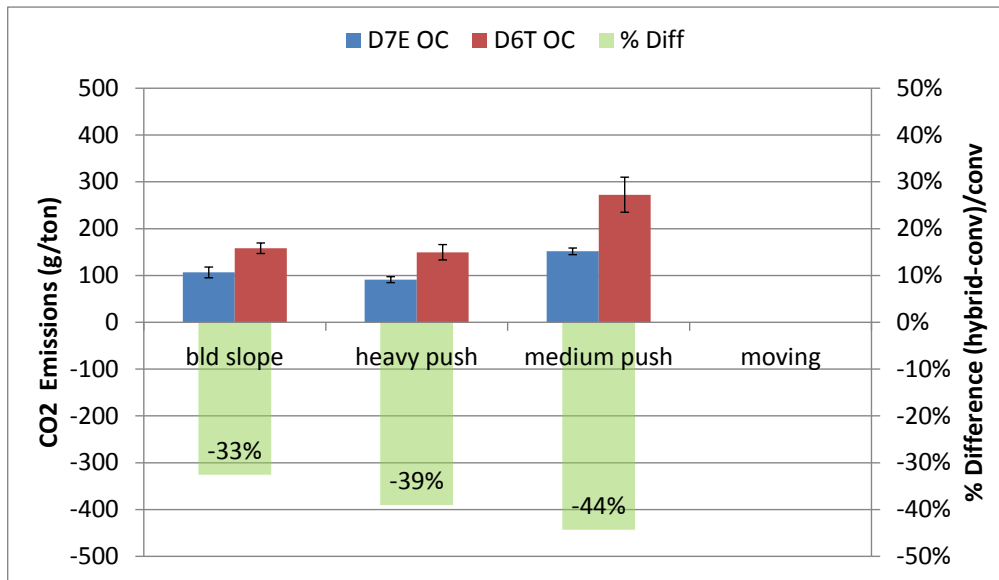


Figure 6-7 Controlled in-use testing CO<sub>2</sub> emissions g/ton D7E vs D6T.

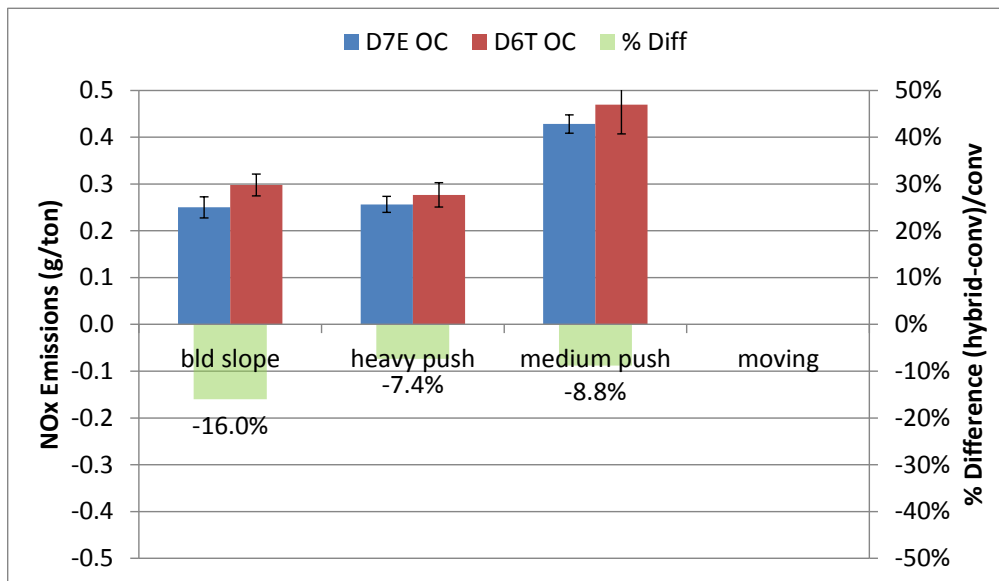


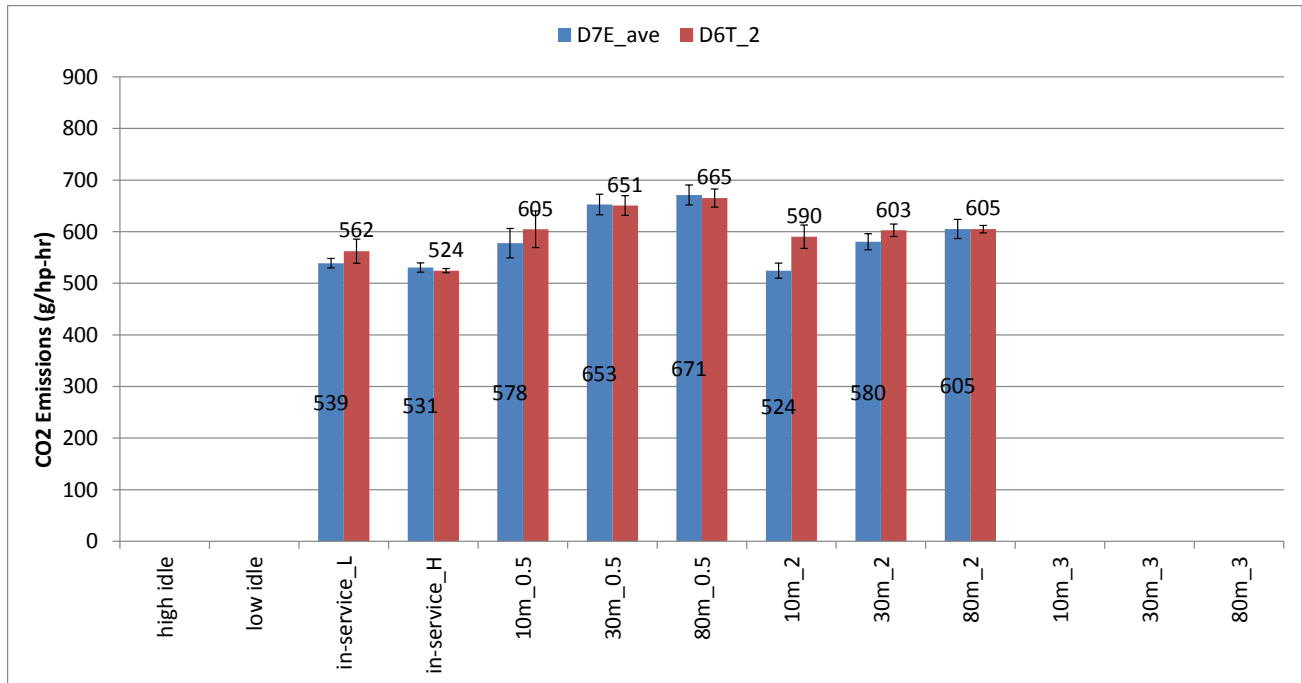
Figure 6-8 Controlled in-use testing NO<sub>x</sub> emissions g/ton D7E vs D6T.

### In-use tests

The main focus of this section is on the brake specific (bs) and fuel specific (fs) emissions basis. The bs-emissions were compared for the controlled pull testing to the in-service rock pushing tests. This section provides comparability of the in-use testing to the controlled testing results. One point of caution is that the brake specific emissions are not appropriate for hybrid to conventional comparisons. Hybrids typically reduce their engine size with energy storage where the effective load is higher than the measured engine load. One would need to measure the true load (i.e. tons of material moved for off-road applications) to make a fair comparison. However this section can be used to consider trends between the units over different load tests on a brake specific basis. Thus, the purpose of this section is not for the hybrid benefit, but to look at differences between test mode types on a brake specific basis.

The bsCO<sub>2</sub> results for the controlled pull and in-use testing are presented in Figure 6-9 on a g/hp-hr basis. Overall, the results show the bsCO<sub>2</sub> varies from 524 to 671 g/hp-hr for the D7E where the

highest value was for the 80m light bin pull. The D6T bsCO<sub>2</sub> varied from 524 to 665 g/hp-hr where the highest value was also for the 80 m light bin pull. The in-service tests showed a slightly overall lower bsCO<sub>2</sub> emission of 540 g/hp-hr for both the hybrid and conventional units compared to the range of 540 to 650 g/hp-hr for the controlled bin pull tests. This suggests the in-use testing average load was slightly higher, but was with-in reasonable loads found for in-use construction equipment. The purpose of the bin pull tests was to quantify the hybrid benefit over a range of loads so the pull tests were designed to have a larger range as determined in this section.



**Figure 6-9 CO<sub>2</sub> emissions on a brake specific basis for the different controlled push tests.**

<sup>1</sup> Percent differences not relevant for hybrids benefits due to lower loads as a result of hybridizing, but it is interesting that similar negative bias trends were found on a brake specific basis for all modes.

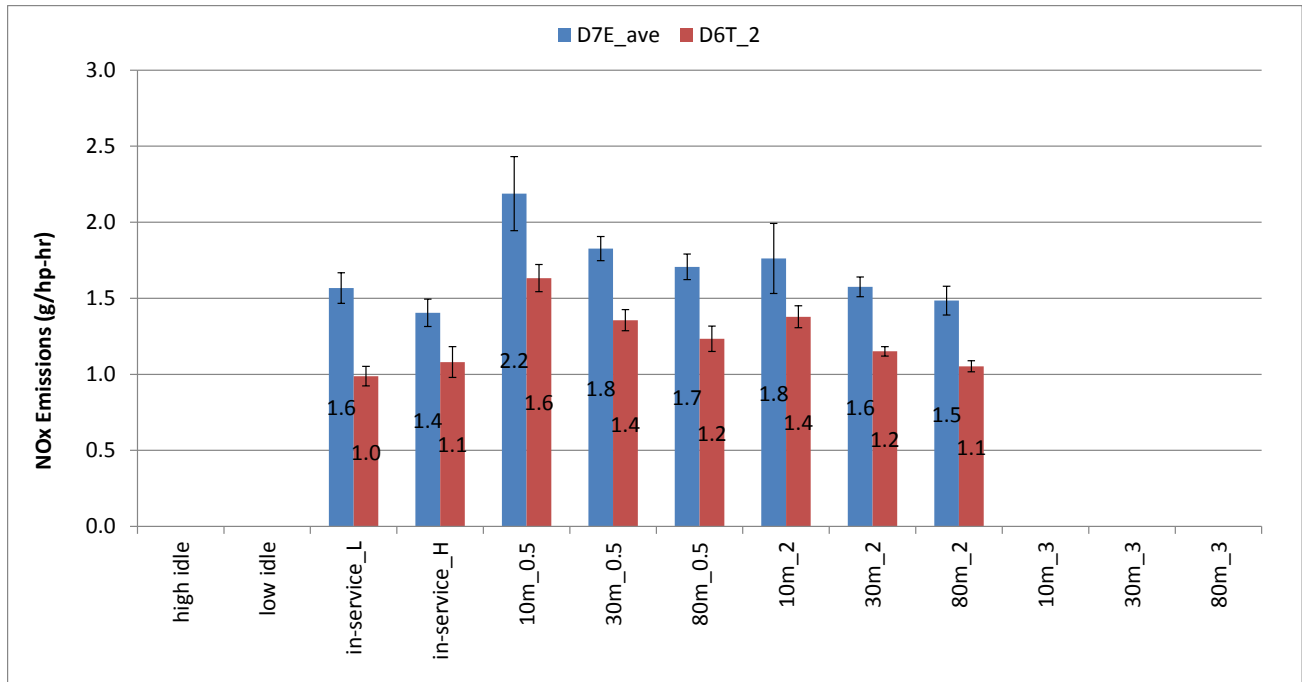
The NO<sub>x</sub> results for the controlled pull testing are presented in Figure 6-10 and Figure 6-11 on a g/hp-hr basis. Figure 6-10 shows the comparison during the control pull modes and in-service rock pushing modes and Figure 6-11 shows the comparison during earth excavation and slope building during the controlled in-service tests. Overall, the results show the in-service tests were similar to the heavy loaded 30 m and 80 m pull tests, see Figure 6-10. The in-service D7E bsNO<sub>x</sub> emissions ranged from 1.6 to 1.4 g/hp-hr which was with-in the range of the bsNO<sub>x</sub> emissions for the 30 and 80 m heavy pull tests. The lighter pull tests showed higher bsNO<sub>x</sub> as is expected for lighter loaded operations. The conventional showed a similar trend for the in-service and controlled pull tests where the bsNO<sub>x</sub> ranged from 1.1 to 1.5 g/hp-h, respectively. The fuel specific emissions showed a similar trend as in Figure 6-10 and are not presented, but are available in Appendix I. The fact that the fuel specific emissions are similar suggests the lug curves used to calculation gross power are reasonable.

The in-service OC work showed slightly lower bsNO<sub>x</sub> emissions for both the conventional and hybrid systems as shown in Figure 6-11. The bsNO<sub>x</sub> ranged from 1.2 to 1.5 for the hybrid and 1.0 to 1.2 for the conventional. The in-service bsNO<sub>x</sub> emissions at OC showed a slightly overall lower emissions rate than the in-service rock pushing and controlled pull tests at WM. This may be a result of high sustained loads while pushing earth compared to rock. Interestingly the relative error was about the same with a typical % difference of around 30% - 40% higher NO<sub>x</sub> for the D7E on a brake specific basis for both test operations. Thus, the overall magnitude changed, but so did the relative



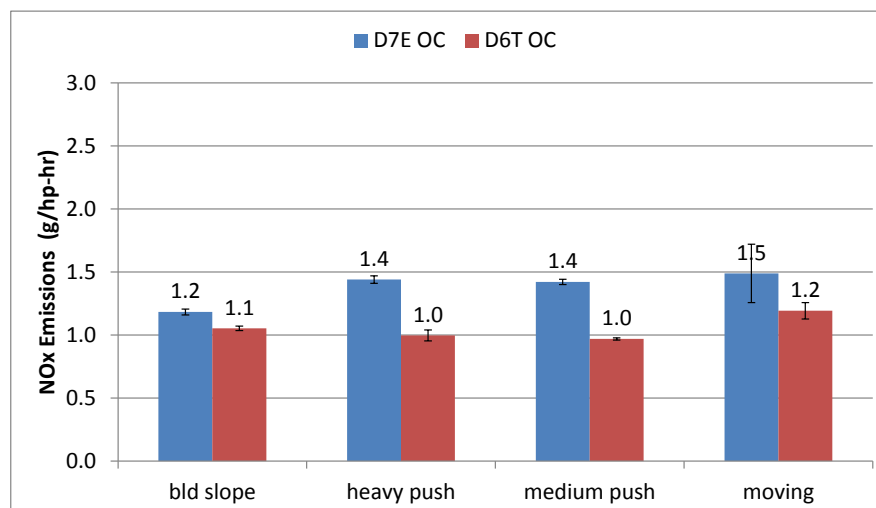
differences. The percent differences for the pulls and the pushes were about the same suggesting the work was similar as seen by the engine. This suggests the performance difference between the controlled in-service testing at WM and OC may be more of a result of the blade size differences than the hybrid system.

The similar bsNO<sub>x</sub> bias between the two controlled tests suggests the pull test is a more appropriate test since there are fewer variables affecting the data. These results, thus, support using the pull tests as the main analysis approach for the comparison between the hybrid and conventional unit.



**Figure 6-10 NO<sub>x</sub> emissions on a brake specific basis for the different controlled push tests, WM.**

<sup>1</sup> Percent differences not relevant for hybrids benefits due to lower loads as a result of hybridizing, but it is interesting that similar negative bias trends were found on a brake specific basis for all modes.



**Figure 6-11 NO<sub>x</sub> emissions on a brake specific basis for the different controlled in-use tests, OC.**

<sup>1</sup> Percent differences not relevant for hybrids benefits due to lower loads as a result of hybridizing, but it is interesting that similar negative bias trends were found on a brake specific basis for all modes.

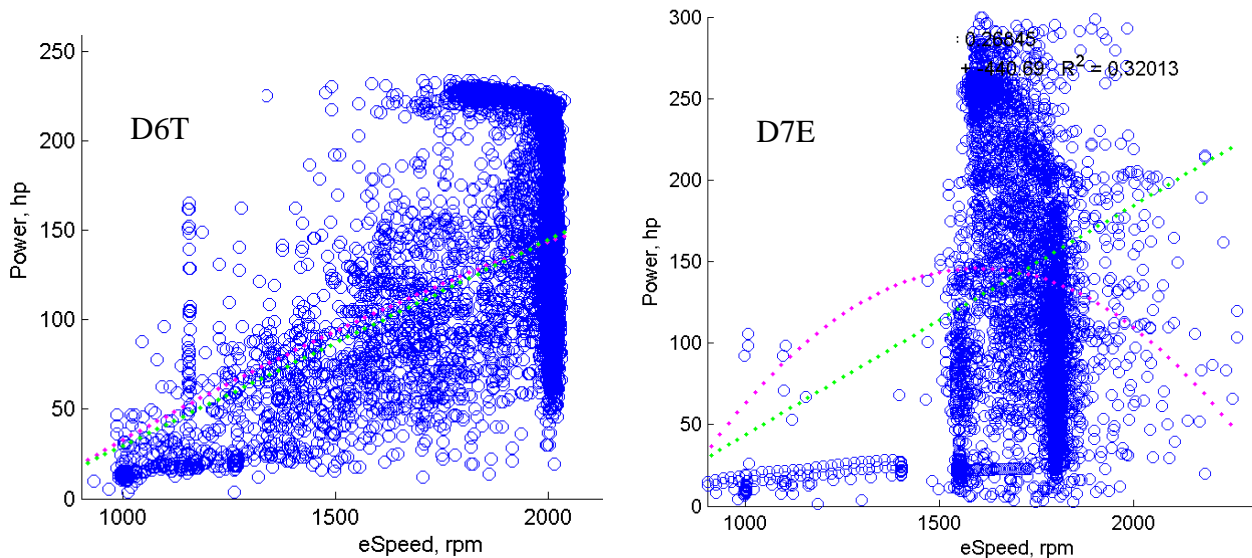
The hybrid NO<sub>x</sub> emission certification results are lower than the conventional D6T. Table 6-2 shows the emission certification results for the units tested as part of this study. The bsNO<sub>x</sub> for the D6T is 2.15 g/hp-h where the D7E is 1.48 g/hp-h. Previously we showed for all operational modes the hybrid bsNO<sub>x</sub> emissions are higher for the hybrid compared to the conventional. This suggests that there may be some operational modes found in-use that are not represented by the certification cycle.

Deeper investigation shows that there are differences in the engine operation that may be causing the higher hybrid NO<sub>x</sub> emissions. Figure 6-12 shows the D6T and D7E engine load versus engine speed on a second by second basis for the controlled in-use testing. This data suggests the D6T and D7E operate over a very different portion of the engine map. The D6T covers a wider range with a high concentration at full load and others at part load whereas the D7E operates over a very narrow range in the middle of the engine map. The specific narrow range of the D7E in-use operation may be operating in a higher weighted NO<sub>x</sub> region of the engine map not captured during the certification process. Although the differences cannot be quantified, this observation provides some suggestion for why there may be a negative NO<sub>x</sub> benefit for the hybrid over the conventional.

**Table 6-2 Equipment emission certification results**

	ARB EO Emissions Certification g/hp-h				
	HC	NOx	NOx	CO	mg PM
D7E-T4i	0.03	1.48	--	0.134	2.7
D6T-T4i	0.09	2.15	--	0.268	5.4
D8T-T4i	0.17	2.01	--	0.671	1.3
D8R-T2	tbd	tbd	tbd	tbd	tbd

<sup>1</sup> Emission certification results downloaded from ARB's executive order website database.  
<http://www.arb.ca.gov/msprog/offroad/cert/cert.php>



**Figure 6-12 Engine load as a function of engine speed for the D6T and D7E**

**Table 6-3 Equipment emission certification standard**

hp	Tier	Year	CERT Standards (g/hp-h)		
			CO	NMHC+NO <sub>x</sub>	PM
75 to 101	2	2004 - 2007	3.7	5.6	0.30
75 to 101	3	2008+	3.7	3.5	0.30
101 to 174	2	2003 - 2006	3.7	4.9	0.22
101 to 174	3	2007+	3.7	3.0	0.22
174 to 302	2	2003 - 2005	2.6	4.9	0.15
174 to 302	3	2006+	2.6	3.0	0.15
174 to 302	4i	2011 or 2012	2.6	3.0	0.015
302 to 449	2	2001 - 2005	2.6	4.8	0.15
302 to 449	4i	2012	2.6	3.0	0.015
449 to 603	2	2001 - 2005	2.6	4.8	0.15
449 to 603	3	2006+	2.6	3.0	0.15

<sup>1</sup> Certification standards as per 40 CFR

<sup>2</sup> The D7E and D6T are in the 174 to 302 hp category and the D8T and D8R are in the 302 to 449 hp category.

The measured brake specific emissions for PM, CO, and THC are presented in Table 6-4. The results show that the PM and CO emissions are well below the certification standards, see Table 6-3, and certification values. THC is very close to the EO emissions certification in Table 6-2.

**Table 6-4 PM, CO, and THC brake specific emissions for the controlled pull testing**

Cycle	Brake Specific Emissions (g/hp-hr)		
	mg PM	CO	THC
D7E	0.2	< 0	0.049
D6T	0.3	< 0	0.026
D8T	0.4	<0	0.025
D8R	n/a	n/a	n/a

### 6.1.3 D7E-T4i vs D8T-T4i Results

This section is broken into two sub sections, 1) controlled pull tests and 2) in-service tests. The controlled pull tests represent part of the basis for the overall comparison and the in-use tests provide additional support for this analysis. The in-service tests also provide context that the testing was performed with reasonable loads and equipment usage. For more details about the different testing types see Section 5.1.6.

#### *Controlled pull tests*

The CO<sub>2</sub> results for the controlled pull are presented in Figure 6-13 on a g/hr and a g/ton basis. For each testing mode, as well as the idle modes, comparisons are made between the hybrid and conventional bulldozer. For the controlled pull tests, the tests are done in terms of the distance the material is being pulled (i.e., 10 m, 30 m, and 80 m) and the amount of material in the bin being

pulled (i.e., 0.5, 2, and 3). The right y-axis shows the results in terms of percent difference for the hybrid vs. conventional bulldozer.

Overall, the results show a hybrid benefit ranging from approximately 25 to 60% for the hybrid bulldozer for nearly all of the controlled tests and they are statistically different at 90% confidence except for high idle. The benefit for the hybrid bulldozer is more significant for the lower weight bins and for the shorter pull distances. The difference between the low idle emissions for the hybrid and conventional bulldozers was comparable within the experimental variability. The D8T was a larger piece of equipment and was able to pull a heavier bin called “\_3”. The CO<sub>2</sub> emissions were lowest for bin 3 on a g/ton basis but were higher on a g/hr basis.

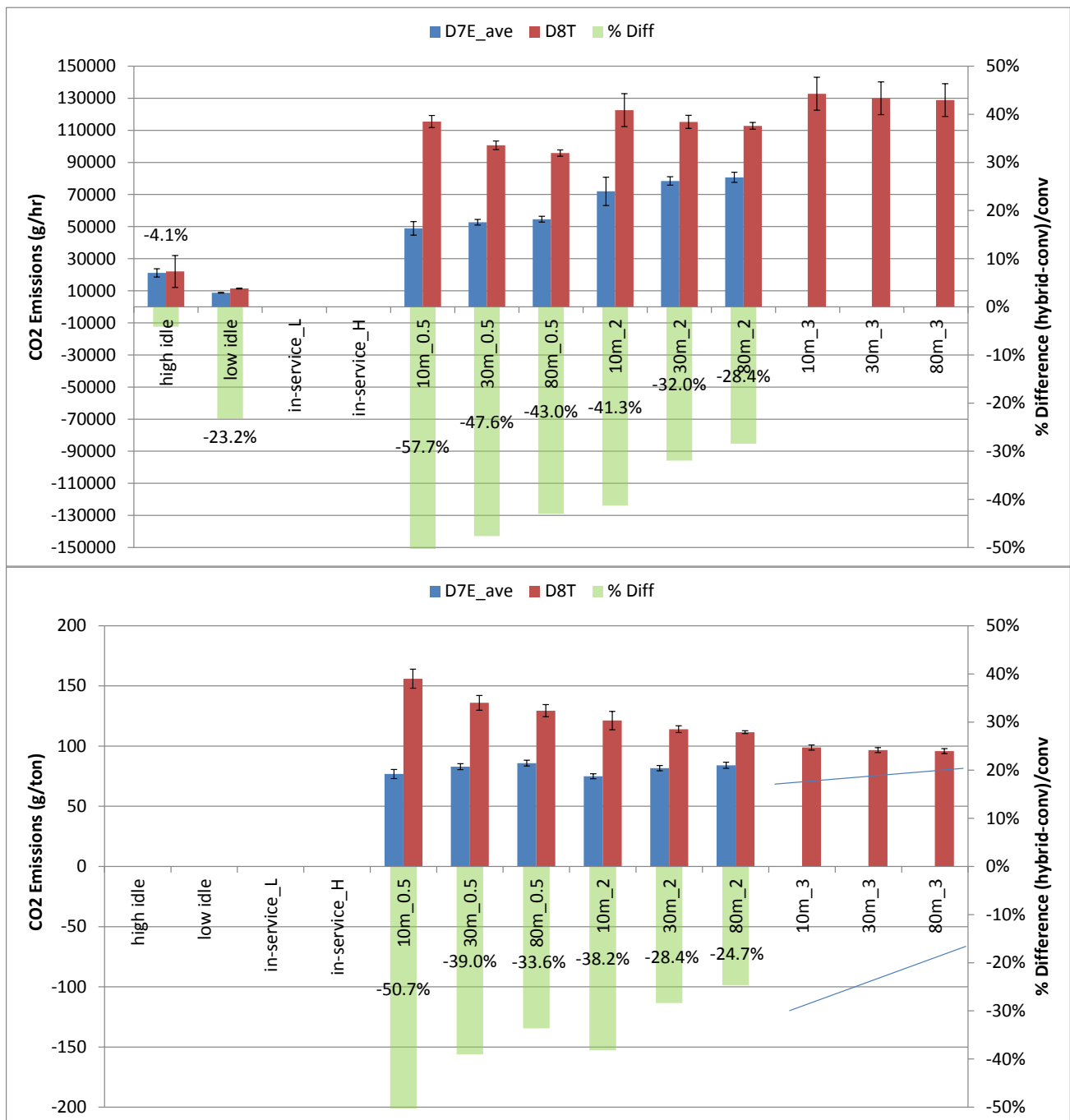


Figure 6-13 CO<sub>2</sub> Emissions on a g/hr and g/ton basis for the controlled pull tests D8T.

Since the D7E could not pull this bin due to its weight, an estimate of the emissions were predicted to suggest a comparison at this higher load. The blue lines in the g/ton figure represent an estimated D7E CO<sub>2</sub> emission if it could pull the heavier bin. The estimated difference ranged from 30% to 20%.

The NO<sub>x</sub> results for the controlled pull are presented in Figure 6-14 on a g/hr and a g/ton basis. The NO<sub>x</sub> results show lower emissions for the hybrid under nearly all test conditions. The NO<sub>x</sub> decrease ranged up to 54% on a g/hr basis and up to 47% on a g/ton basis. The decrease in NO<sub>x</sub> for the hybrid equipment compared to the D8T was different than for the D6T. The lower hybrid NO<sub>x</sub> emissions may be due to the low duty cycle used for the comparison for like testing of the D8T as compared to the D6T. Additional discussion will follow on a brake specific basis.

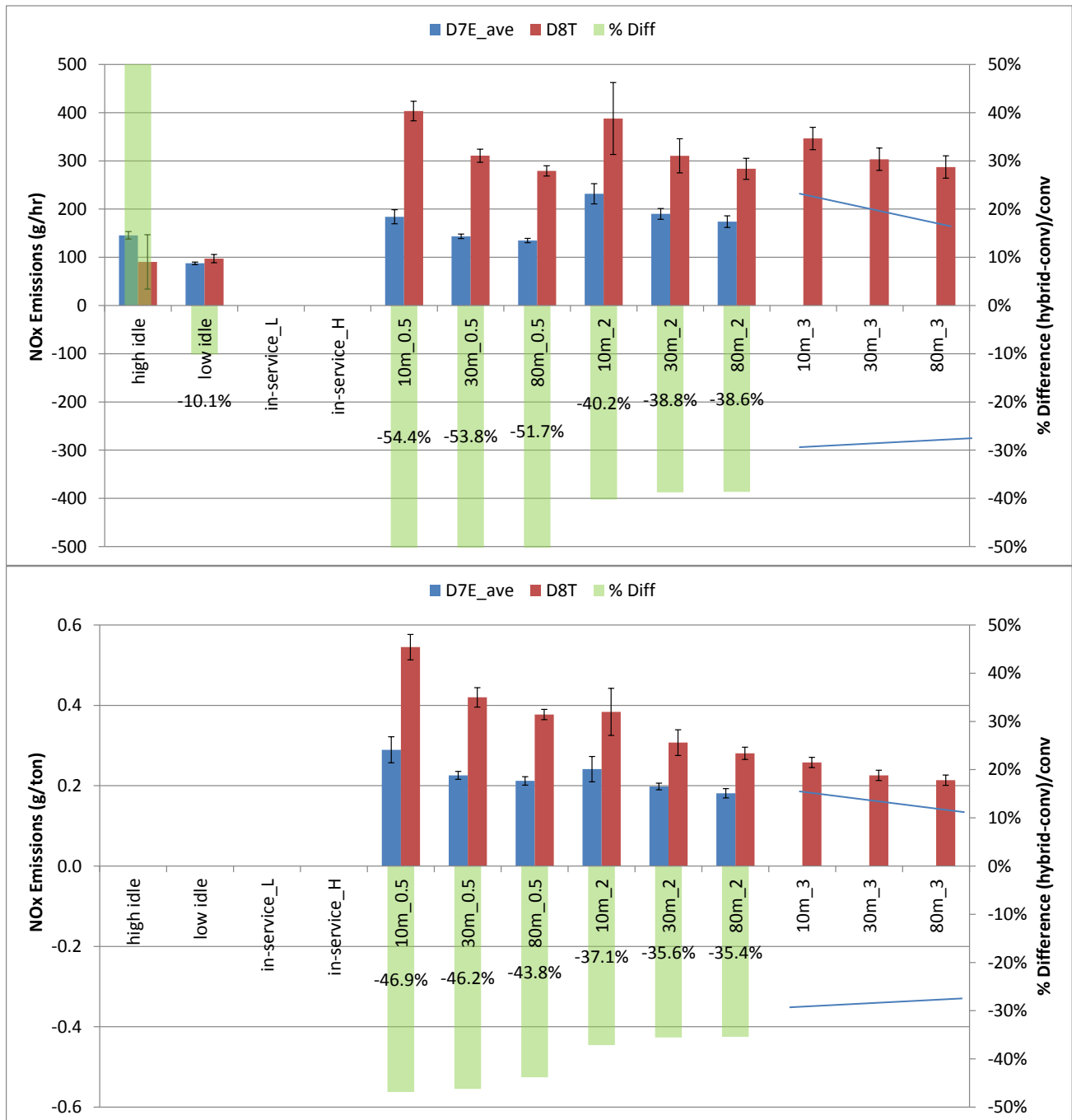


Figure 6-14 NO<sub>x</sub> Emissions on a g/hr and g/ton basis for the controlled pull tests D8T.

The NO<sub>x</sub> decreases are lower for the heavier bin than the lighter bin. For the lighter bin, NO<sub>x</sub> decreases were found for the 10, 30, and 80 meter distances on a g/hr and g/ton basis, but the percentage decreases were more comparable within the experimental variability on a g/hr basis. The idle results showed mixed results, with a NO<sub>x</sub> increase for the hybrid bulldozer for the high idle and NO<sub>x</sub> decrease for the hybrid bulldozer for the low idle, but these differences are not statistically significant.

Since the D7E could not pull bin 3 due to its weight, an estimate of the NO<sub>x</sub> emissions were also predicted to suggest a comparison at this higher load. The blue lines in the g/ton figure represent an estimated D7E NO<sub>x</sub> emission if it could pull the heavier bin. The estimated difference ranged from 30% to 25% benefit for the hybrid over the conventional.

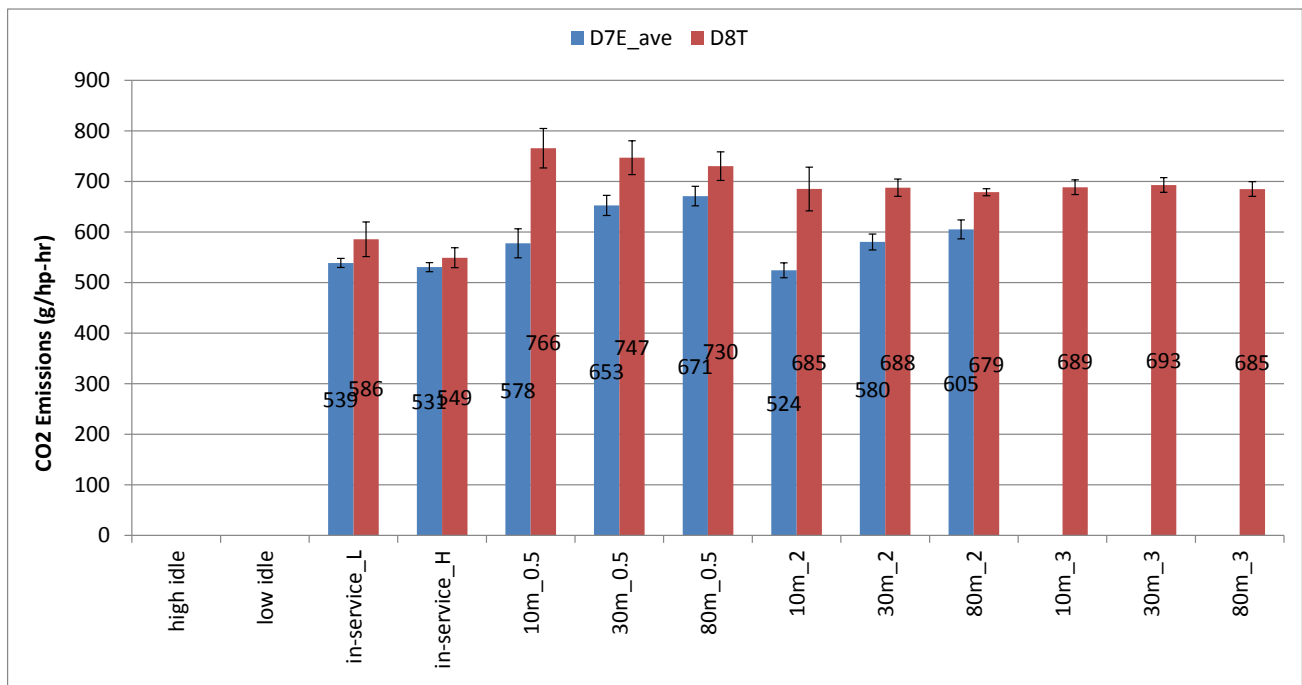
The PM, CO, and THC emissions were relatively low and similar to the D6T comparisons and are thus not presented here. These results can be found in Appendix I.

#### *In-service tests*

The main focus of this section is on the brake specific (bs) and fuel specific (fs) emissions. The bs-emissions were compared for the controlled pull testing to the in-service rock pushing tests. This section provides comparability of the in-use testing to the controlled testing results. One point of caution is that the brake specific emissions are not appropriate for hybrid to conventional comparisons. Hybrids typically reduce their engine size with energy storage where the effective load is higher than the measured engine load. One would need to measure the true load (i.e. tons of material moved) to make a fair comparison. However this section can be used to consider trends between the units over different load tests on a brake specific basis. Thus, the purpose of this section is not for the hybrid benefit, but to look at consistent differences between test mode types on a brake specific basis.

The bsCO<sub>2</sub> results for the controlled pull and in-use testing are presented in Figure 6-15 on a g/hp-hr basis. Overall, the results show the bsCO<sub>2</sub> varies from 524 to 671 g/hp-hr for the D7E where the highest value was for the 80m light bin pull. The D8T bsCO<sub>2</sub> varied from 550 to 766 g/hp-hr where the highest value was for the 10 m light bin pull. The in-service tests showed a slightly overall lower bsCO<sub>2</sub> emission of 540 g/hp-hr for the hybrid, but the conventional unit was lower for the in-use testing compared to the bin pull testing. A third bin was tested for the D8T which was too heavy for the D7E and is denoted by “\_3”. This bin was at the design limits of the pull skid where more load was not possible.

Ideally the D8T should have been pulled with bsCO<sub>2</sub> in the 550 to 650 g/hp-hr levels, similar to the D6T vs D7E comparison. Unfortunately the D7E could not pull the loads of the D8T so higher bin loads would not have been an apples-to-apples comparison. Thus the D8T is obviously a much different unit and may not be an ideal comparison to the D7E. According to stakeholders though the D7E is replacing the D8T, thus, some benefit quantification is needed to provide guidance on its impact. As such this section considers next the bsNO<sub>x</sub> benefit on a brake specific basis. Additionally the higher bsCO<sub>2</sub> does not invalidate the results, but does suggest the hybrid benefit results are over estimated. Thus, it is expected the true benefit from the hybridization will be less than what is presented.



**Figure 6-15 CO<sub>2</sub> emissions on a g/hp-hr basis for the D8T.**

The NO<sub>x</sub> results for the controlled in-use testing are presented in Figure 6-16 on a g/hp-hr basis. Figure 6-10 shows the comparison during the pull tests and in-use rock pushing. Overall, the results show the in-use tests were similar to the heavy loaded 30 m and 80 m pull tests, see Figure 6-16. The in-service D7E bsNO<sub>x</sub> emissions ranged from 1.6 to 1.4 g/hp-hr which was within the range of the bsNO<sub>x</sub> emissions for the 30 and 80 m heavy pull tests. The lighter pull tests showed higher bsNO<sub>x</sub> as is expected for lighter loaded tests.

The conventional showed a slightly different trend between the in-use testing and controlled bin testing even for the heaviest bin #3. The in-use bsNO<sub>x</sub> ranged from 1.3 to 1.5 g/hp-h where the largest bin pull tests was 1.6 to 1.9 g/hp-h. The lighter bin pulls showed bsNO<sub>x</sub> as high as 2.6 g/hp-h almost two times that of the in-use testing. This suggests light operational differences between the D8T and D7E will reflect in very large benefits for the D7E. It is unlikely the industry of landfills operate their bull dozer in a light fashion, as quantified in the activity analysis section above. Thus, this suggests the emissions are also overestimated for the D8T and thus, the hybrid benefit should also be overestimated. The fuel specific emissions showed a similar trend as in Figure 6-16 and are not presented, but are available in Appendix I. The fact that the fuel specific emissions are similar suggests the lug curves used to calculate gross power are reasonable.

Figure 6-17 shows the D8T engine load versus engine speed on a second by second basis for the controlled pull and in-use testing. This data shows the D8T engine power and engine speed vary over the range of the engines lug curve. This is similar to the D6T conventional data shown in Figure 6-12. Again this suggests the D8T and D7E operate over different portions of the engine map. The D8T covers a wider range of the map whereas the D7E operates over a very narrow range. The narrow range of the D7E in-use operation may be operating in a higher weighted NO<sub>x</sub> region of the engine map not weighted during the certification process. The effect of this difference is not observed with the D8T, but is expected to still be present, but is masked by the low duty cycle utilized during the pull tests. The bsNO<sub>x</sub> emissions are slightly higher for D7E compared to the D8T, thus suggesting the certification of the D7E should be higher, but the D8T shows a higher certification value, see Table 6-2. Again this suggests a possible operational difference with the D7E and its certification process.

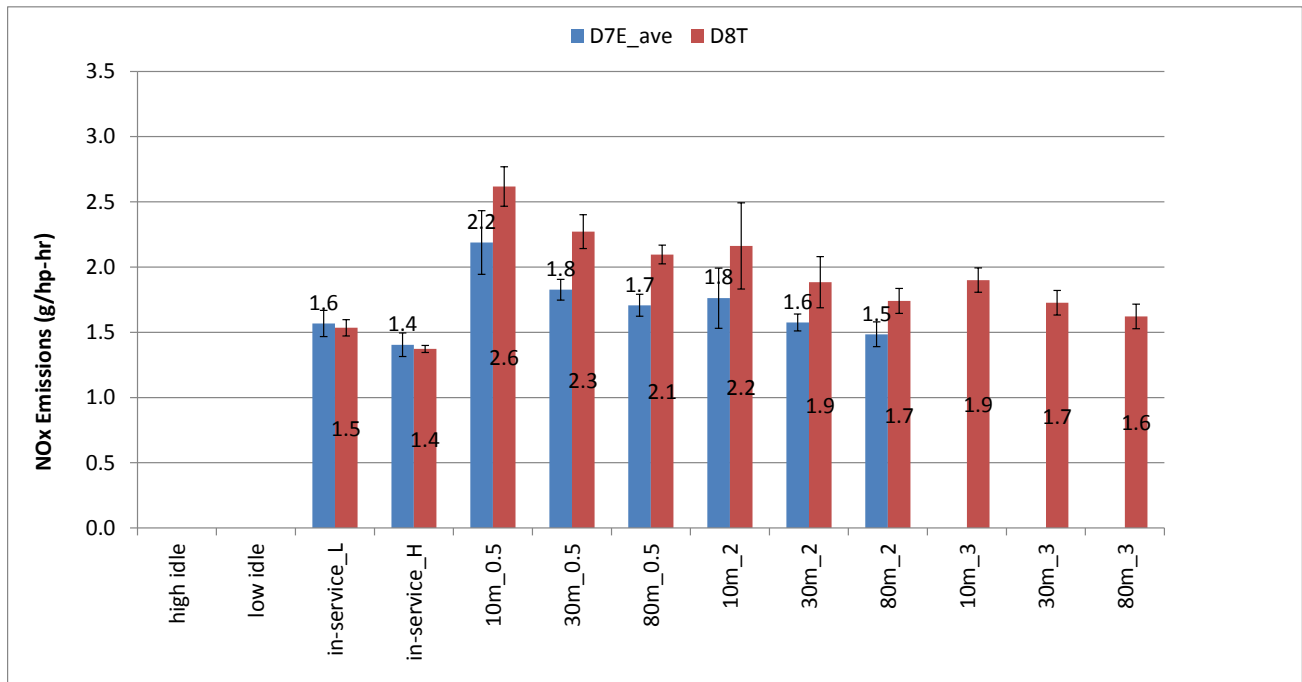


Figure 6-16 NO<sub>x</sub> emissions on a g/hp-hr basis for the D8T.

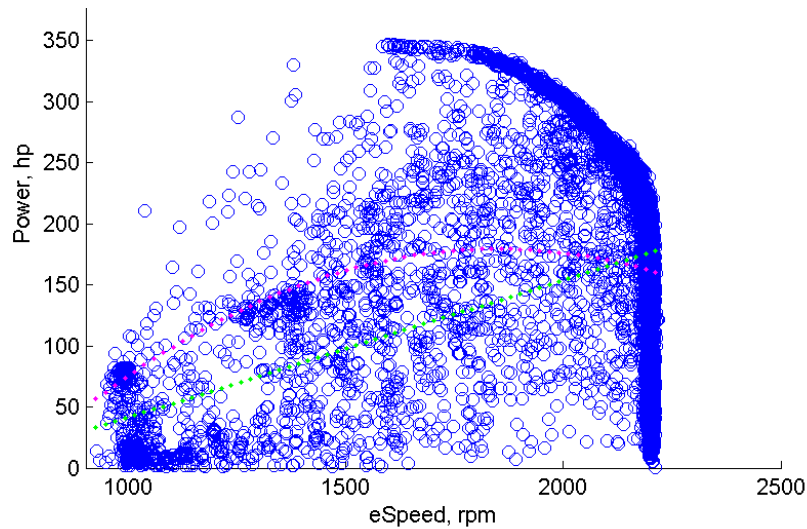


Figure 6-17 Engine load as a function of engine speed for the D8T

#### 6.1.4 D7E-T4i vs D8R-T2 Results

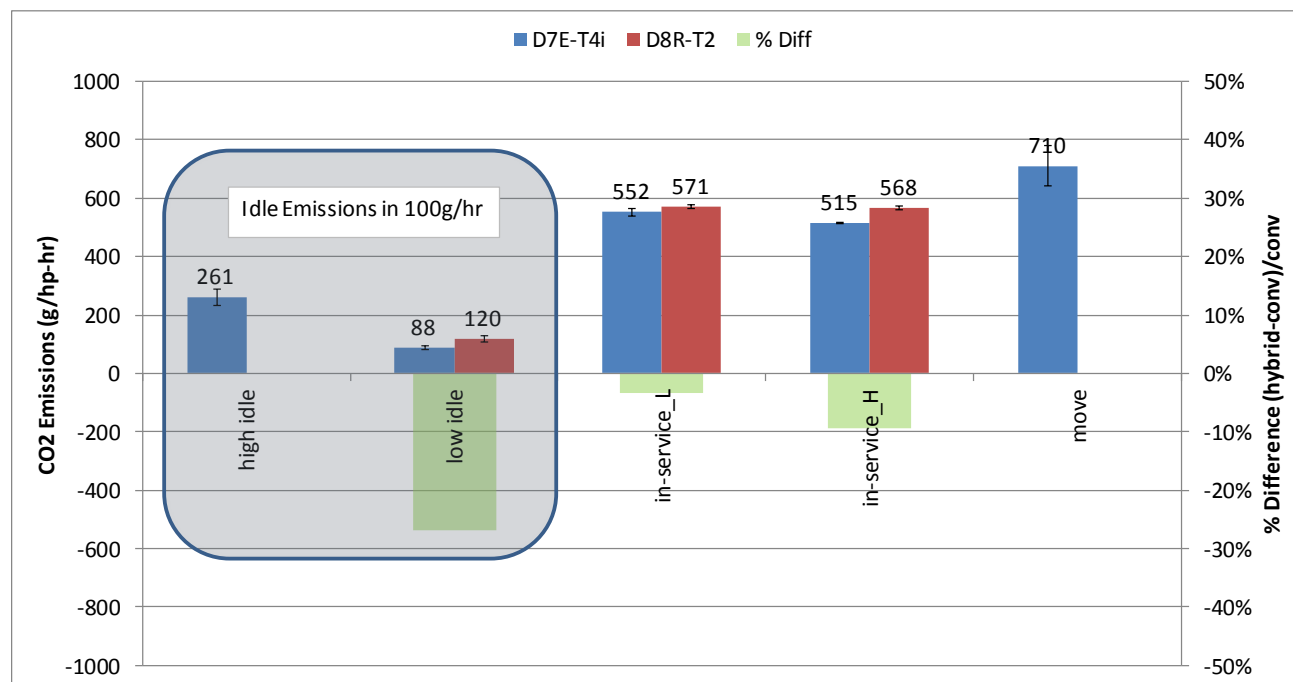
This section considers only in-revenue service comparison for both the conventional and hybrid during landfill operations. The conventional was a Tier 2 D8R not equipped with a DPF and the hybrid was WM's D7E T4i equipped with a DPF. This comparison can be used for differences to older certification MY units and for comparison with real in-revenue service operational benefits. For more details about the different testing types see Section 5.1.6.

The CO<sub>2</sub> results for the in-revenue service testing are presented in Figure 6-18 on a g/hp-hr basis and on a g/hr basis for idle. Overall, the results show the bsCO<sub>2</sub> varies from 515 to 710 g/hp-hr for the D7E where the highest bsCO<sub>2</sub> emissions was for the move test and the lowest was for the heavy load test. The D8R bsCO<sub>2</sub> varied from 568 to 571 g/hp-hr between the heavy and light load testing. There



were no move modes quantified for the D8R during its refuse operation. The D7E showed lower idle CO<sub>2</sub> g/hr emissions for the low speed idle which was about 30% lower than the D8R.

The in-revenue tests showed a slightly overall lower bsCO<sub>2</sub> emission of 550 g/hp-hr for both the hybrid and conventional units compared to the range of 540 to 650 g/hp-h for the controlled pull tests. This again suggests the in-use testing average load was slightly higher than the pull testing, but with-in reasonable loads found for in-use construction equipment.



**Figure 6-18 CO<sub>2</sub> emissions for the D8R vs D7E during in-revenue service testing**

The NO<sub>x</sub> results for the in-revenue service testing are presented in Figure 6-19 on a g/hp-hr basis and on a g/hr basis for idle. The in-revenue service D7E bsNO<sub>x</sub> emissions ranged from 1.5 to 1.6 g/hp-hr which was with-in the range of the bsNO<sub>x</sub> emissions for the 30 and 80 m heavy pull tests, see Figure 6-16. The lighter pull tests showed higher bsNO<sub>x</sub> as is expected for lighter loaded tests. The lighter bin pulls agrees well with the move tests where the move bsNO<sub>x</sub> was 2.1 g/hp-hr, see Figure 6-19.

The D8R conventional showed a much higher bsNO<sub>x</sub> and averaged 3.9 g/hp-h for both the heavy and light load testing, see Figure 6-19. The low speed idle emission were also higher for the D8R compared to the D7E from 146 g/hr to 87 g/hr, respectively. Figure 6-20 shows a plot of the NO<sub>x</sub> emissions in g/hr versus power for each of the test points for the D8R and D7E. The range of power is much higher for the D8R compared to the D7E as would be expected for the larger displacement engine. This figure provides a metric of emissions comparison as a function of load to quantify the benefit by comparing the best fit line slopes. The slope from the best fit line represents the brake specific emissions. The slope for the D8R is 3.5 g/hp-hr and the slope for the D7E is 1.0 g/hp-h. The percent difference in slopes is 70% between the D7E and the D8R. This suggests the benefit of the D7E over the D8R for NO<sub>x</sub> is somewhere around 62% (as presented previously) to 70% (presented here). On a material moved basis one would expect a slightly higher benefit (as discussed previously on hybrid comparisons) and maybe as high as 80%. To be conservative 70% is considered the practical benefit in this report.

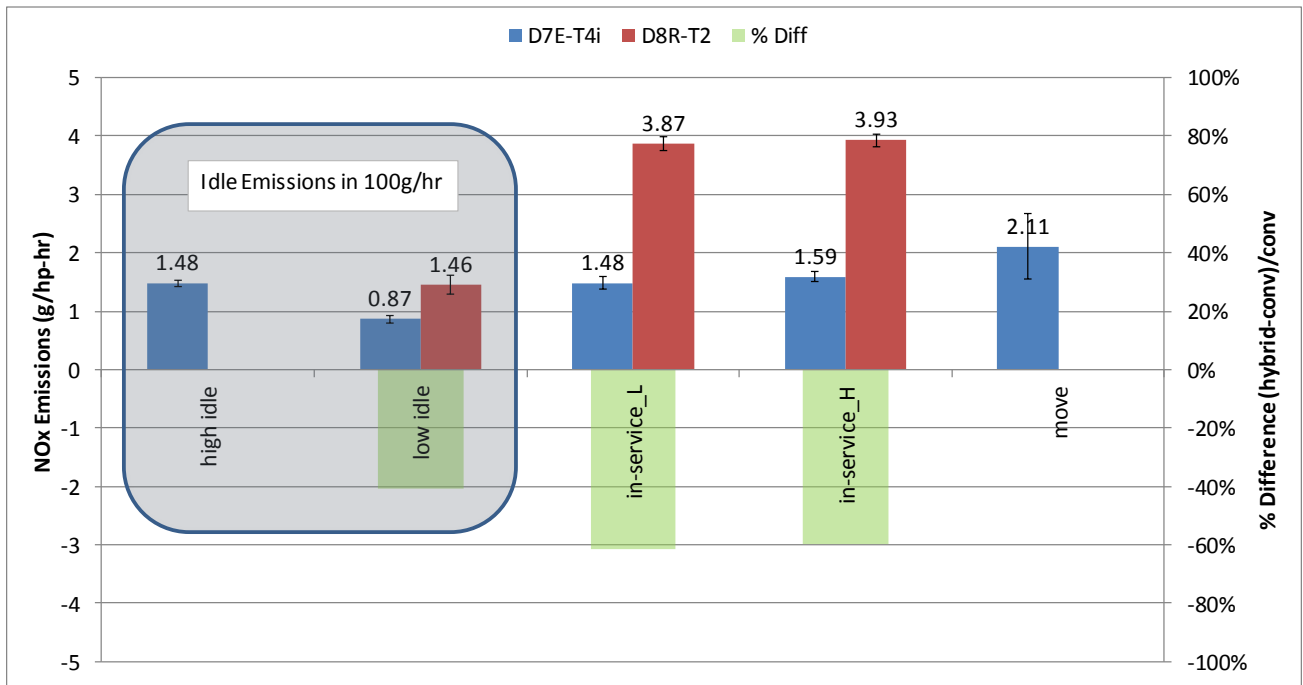


Figure 6-19 NO<sub>x</sub> emissions for the D8R vs D7E during in-revenue service testing

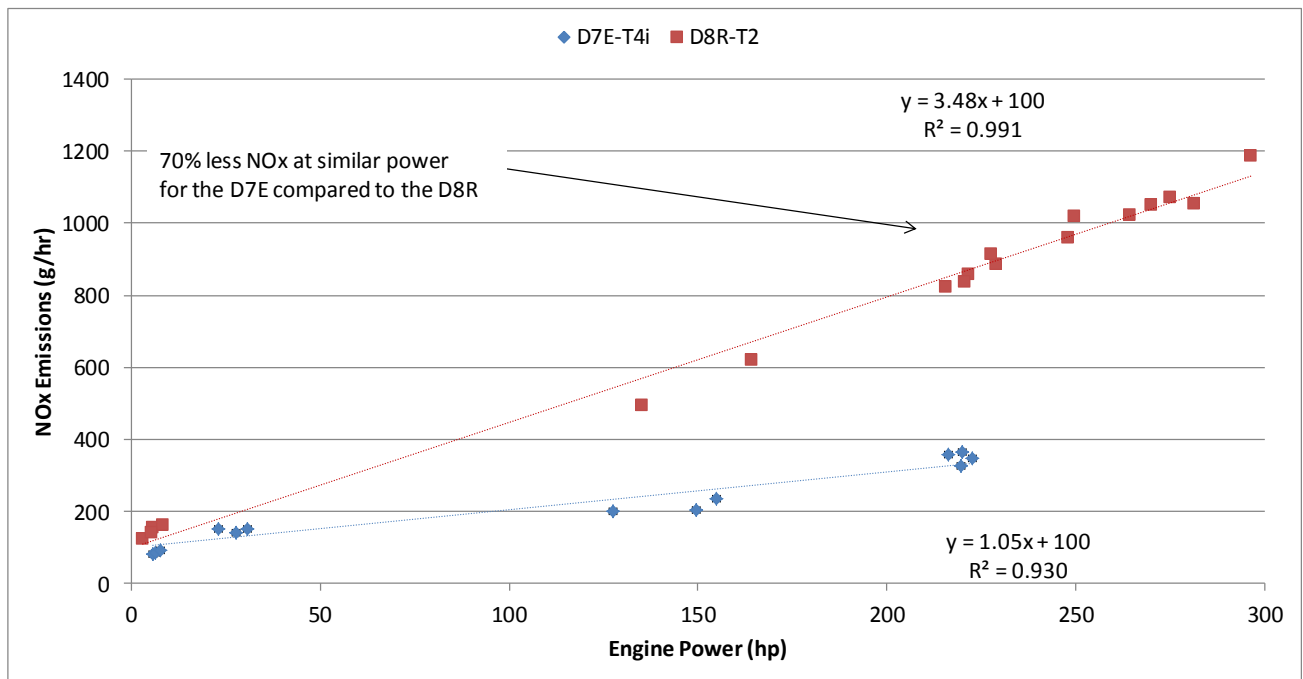


Figure 6-20 NO<sub>x</sub> correlation to power for selected testing points D7E-T4i and D8R-T2.

The PM results for the in-revenue service testing are presented in Figure 6-21 on a g/hp-hr basis and on a g/hr basis for idle. The figures show the PM benefit of the DPF equipped hybrid to be more than 99% for all modes. The bsPM emissions ranged from 168 to 121 mg/hp-hr for the light and heavy load operations. The idle emissions for the D8R were 1250 mg/hr whereas the D7E were only 20 mg/hr. These emission rates agree well with the certification standard for Tier 2 off-road equipment, see Table 6-3.

Figure 6-22 shows the g/hr emissions for THC as a function of engine power between the D7E and D8R. Interestingly the THC emissions increase as a function of power for the D8R with a slightly good correlation of 0.8, but the THC emissions for the DPF equipped D7E were flat from 25 hp to 250 hp. This suggests at light loads the D7E will show higher THC emissions compared to the D8R and lower emissions at high loads compared to the D8R. This is a surprising result as one would expect an ATS system would not only eliminate PM, but also CO and THC. Since there appears to be modes of operation where the conventional has lower THC than the ATS equipped units one needs to assess the toxic impact these newer ATS systems may have on the off-road inventory. THC is responsible for many atmospheric reactions that affect human health. It is unknown what the impact is, but future studies should consider the THC emissions as a function of power and one should not assume THC is reduced for all modes due to the addition of a DPF.

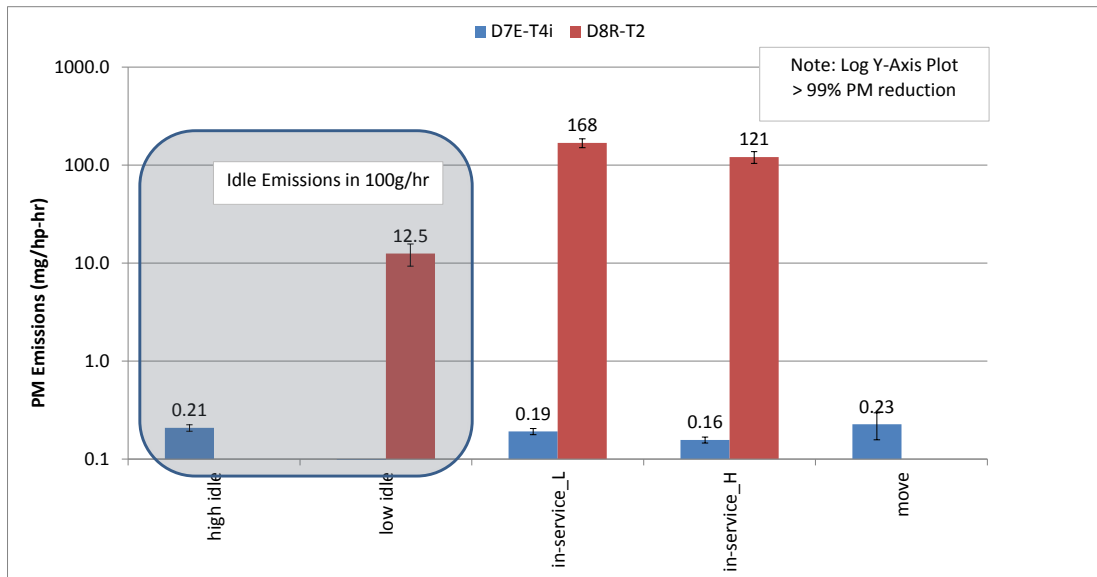


Figure 6-21 PM emissions for the D8R vs D7E during in-revenue service testing

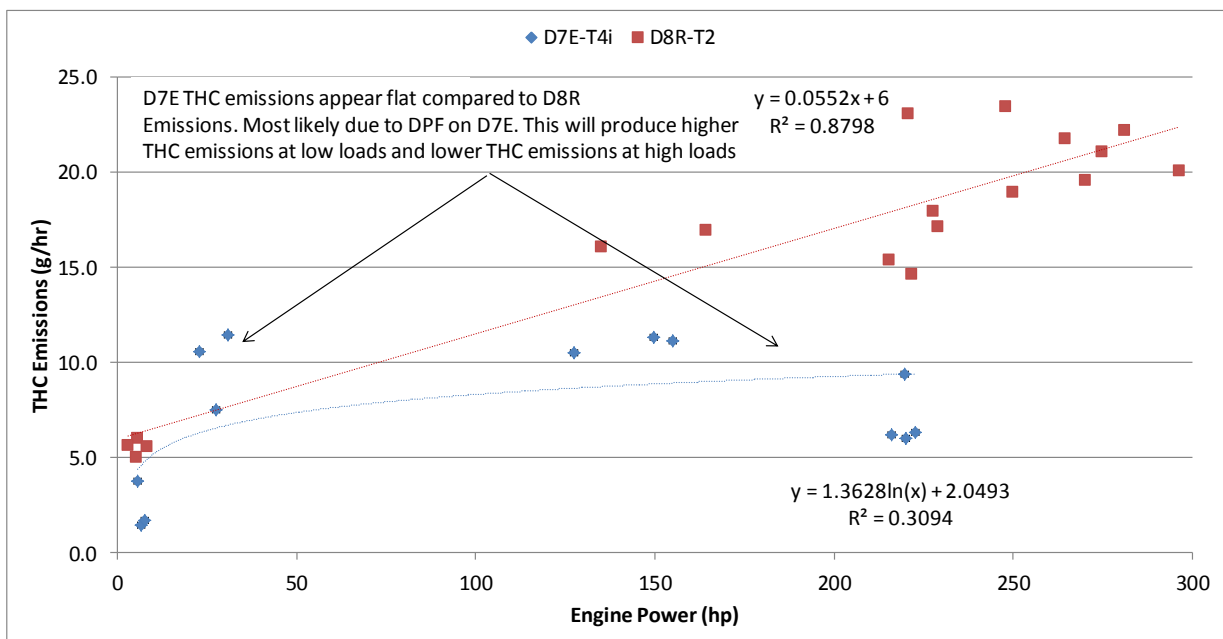
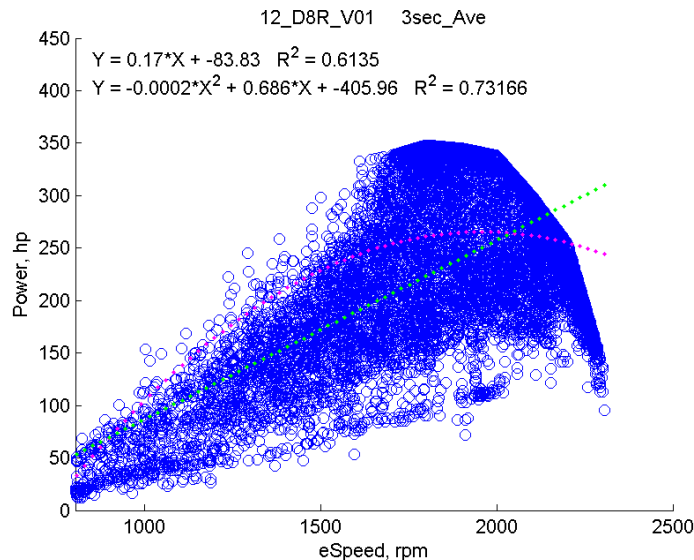


Figure 6-22 THC correlation to power for selected testing points D7E-T4i and D8R-T2.

Figure 6-23 shows the D8R engine load versus engine speed on a second by second basis for the in-revenue service testing. The figure shows the D8R engine power and engine speed vary over the range of the engines lug curve. The D8R variation is similar to the D6T and D8T conventional units as shown in Figure 6-12 and Figure 6-17, but different compared to the D7E. Again this suggests the D8R and D7E operate over a very different portion of the engine map. The D8R covers a wider range of the map whereas the D7E operates over a very narrow range as previously described.



**Figure 6-23 Engine load as a function of engine speed for the D8R**

### 6.1.5 Idle analysis

The hybrid low speed idle emissions were lowest for all the units tested including the D6T-T4i, D8T-T4i, and D8R. The high speed idle was not lowest for the hybrid system mostly because the engine speed for the hybrid high speed idle was 1550 rpm whereas conventionals were around 1000. Most of the idle emissions recorded were for low speed idle thus only the low speed idle will be incorporated into the overall emissions reduction benefit/dis-benefit calculations.

### 6.1.6 Operator differences

Several different operators were used during the course of the testing. At WM three different operators were utilized and at OC a fourth operator. During these tests the comparisons tests were performed by one operator for both the conventional and hybrid comparisons. When the data is evaluated between sites between units on a brake specific basis there is not a significant difference noted. Additional analysis would be needed to investigate this further.

### 6.1.7 Regenerations

Regenerations occurred several times during testing. Fuel consumption, NOx and PM emissions were higher during the regenerations periods. None of the comparison test modes discussed include regeneration emissions. If a regeneration occurred, the regeneration was allowed to complete then the unit was exercised by pushing rock for at least 30 minutes prior to commencing testing.

One would expect stable engine speed operation to have less PM accumulation on the filter and thus require fewer regenerations, but due to regenerations only occurring maybe one every 10 hours they were not easy to track or record between units tested since testing durations were typical 4 – 6 hours

so a regeneration may not have occurred during our testing interval. Additional measurements would be needed to evaluate the frequency of regenerations difference between the hybrid and conventional to quantify the effect of regeneration frequency.

### 6.1.8 Facility differences

Three different materials were evaluated with the bulldozer, landfill refuse, rock, and earth. No noticeable load specific emissions were noticed working with the different materials. Thus, the overall comparison did not appear to be sensitive to the material being used. It is expected though that the main difference between facilities is the level of effort being performed. Light dressing type work will represent lighter loads and thus better benefits for the hybrids and heavy work would represent lower hybrid benefits.

### 6.1.9 Overall benefit

In summary the overall benefit is based on three conventional units. The conventionals are the D6T, the D8T, and the D8R. The overall weighting function was developed in Section 0. In general the overall emissions benefit calculation is based on 80% full load tests at 30 meter push distances, 10% light load pushes at 30 meter distances, and 10% idle. This weighting structure is used for the D6T and D7E. The D8T weighting was not as easy to implement and required some approximations due to the bsCO<sub>2</sub> differences between the D8T and the D7E for the controlled pull tests. Similarly for the D8R the comparison will be made on a modified version of the weighting function of the D6T.

#### *D7E benefit vs. D6T*

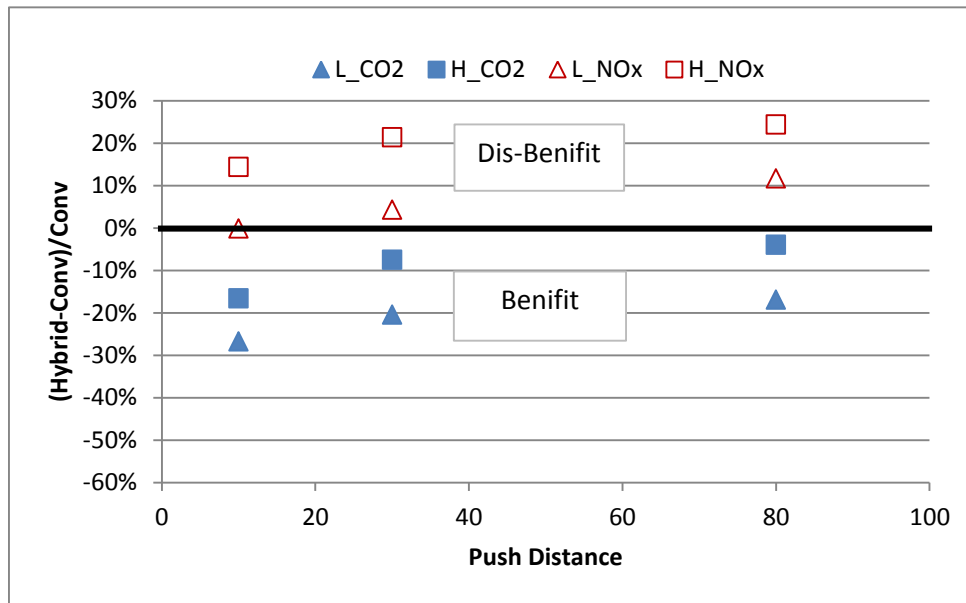
The D6T and D7E are very similar sized units which makes their overall comparison straight forward. The in-use testing, in-service testing, and controlled pull testing all showed comparable emissions and performance characteristics. Thus, this suggests the overall pull tests are a reasonable approach. As such this summary utilizes the control pull tests directly between the D7E and D6T. Table 6-5 shows the results of using the weighing functions derived in Section 0. Figure 6-24 shows the benefit of the D7E to the D6T with push distance and load all in one figure for both NO<sub>x</sub> and CO<sub>2</sub> (fuel consumption). The benefit of the fuel consumption is based on the CO<sub>2</sub> emissions which show the fuel consumption benefit of the hybrid is around 15% on an overall basis.

**Table 6-5 Hybrid weighted comparison to the D6T conventional**

D7E Weighted Comparison to the D6T				
CO <sub>2</sub>	NO <sub>x</sub>	PM	THC	CO
-14%	<b>13%</b>	n/a	n/a	n/a

The NO<sub>x</sub> emissions do not show a benefit for the hybrid, but a dis-benefit with a weighted average of 13% overall. The brake specific and fuel specific analysis confirmed the NO<sub>x</sub> dis-benefit for the in-service testing, in-use testing, and controlled pull tests for all modes. Deeper analysis from the engines lug curve showed that the engine speed range is very narrow and may be causing the higher in-use NO<sub>x</sub> emissions.

No benefit or dis-benefit could be quantified for PM, CO, and THC due to the ATS system on both the D7E and D6T units.



**Figure 6-24 D7E versus D6T comparison over controlled pull testing**

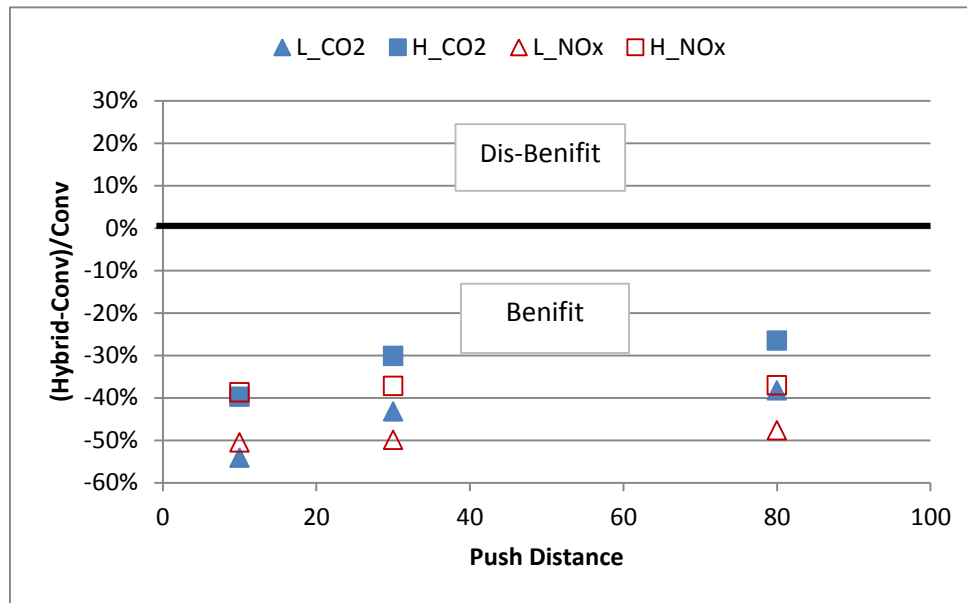
*D7E benefit vs. D8T*

The D8T and D7E were not comparably sized units which makes their overall comparison difficult. The in-use testing and controlled pull testing showed the engines were not operated in a comparable manner, as described earlier. Thus, this suggests the overall pull tests are not a reasonable comparison approach and that the comparison must also be weighted with the in-use testing results. As such this summary utilizes the control pull tests following the derivation in Section 0 with some slight modifications due to the light loads and overestimated emissions benefits between the D7E and D8T.

Table 6-6 shows the results of using the weighing functions derived in Section 0. Figure 6-25 shows the benefit of the D7E to the D8T with push distance and load all in one figure for both NO<sub>x</sub> and CO<sub>2</sub> (fuel consumption). The overall fuel consumption benefit is around 23%. The NO<sub>x</sub> emissions did show a benefit when comparing the hybrid to the D8T conventional with a weighted average of 28% overall. No benefit or dis- benefit could be quantified for THC, CO, or PM due to the ATS system on both the D7E and D8T units.

**Table 6-6 Hybrid weighted comparison to the D8T conventional**

	D7E T4i Weighted Comparison				
	CO2	NOx	PM	CO	THC
D8T-T4i	-23%	-28%	n/a	n/a	n/a



**Figure 6-25 D7E versus D8T over controlled pull testing**

*D7E benefit vs. D8R-T2*

The D8R and D7E are also not comparably sized units which makes their overall comparison difficult. These were tested for in-revenue service testing only. The main comparison is based on a brake specific basis with an average of the 45% high load, 45% medium load, and 10% idle.

Table 6-7 shows the overall benefit of the hybrid over the D8R-T2. The overall fuel consumption benefit is around 22% which is similar to the D8T. The NO<sub>x</sub> emissions show the largest benefit with a weighted average of 70% overall as described earlier. The larger NO<sub>x</sub> benefit is a result of the certification year change and not the hybrid. Additionally there is a significant benefit for PM and CO at more than 99% and 90%, respectively, and a nominal benefit for THC at around 30%.

**Table 6-7 Hybrid weighted comparison to the D8R and other conventionals**

	D7E T4i Weighted Comparison				
	CO2	NOx	PM	CO	THC
D6T-T4i	-14%	13%	n/a	n/a	n/a
D8T -T4i	-23%	-28%	n/a	n/a	n/a
D8R-T2	-23%	-70%	-99%	-90%	-40%

Table 6-8 shows a summary table of the brake specific emissions for PM, CO, and THC for all the in-use tests. The table shows that the emissions from the T4i systems are very low for CO and PM, and slightly reduced for THC. Based on the discussion above for THC the reductions may vary depending on load, but for the most part these overall averages represent the typical loads found during in-service testing.

**Table 6-8 PM, CO, and THC brake specific emissions for the in-use tests.**

Cycle	Brake Specific Emissions (g/hp-hr)		
	mg PM	CO	THC
D7E	0.2	< 0	0.054
D6T	0.2	< 0	0.018
D8T	0.2	< 0	0.014
D8R	144	0.78	0.086



## 6.2 Komatsu excavators

For the excavators emissions results are compared mainly in terms of emissions per unit of time worked (i.e., engine time). This is a metric the industry indirectly uses when planning a job and it is a convenient metric that can be used to compare results from any of the test modes. Results in terms of other metrics, such as work-specific and fuel-specific, are presented in the appendices.

In this subsection we first describe the test units, their operators, and the test sites. We then describe the testing process and how the data were reduced and quality assured. Finally we discuss and compare the test results.

### 6.2.1 Test excavators and operators

Seven excavators were emissions tested, two were model PC200, three were HB215LC-1, and two were PC220. Identifying information, test operator, and test location for each test unit are summarized below in Table 6-9. The locations where they were tested are described in section 0 of this report.

**Table 6-9 Test Excavator Descriptions**

Test Sample ID - long	HB215 DD	PC200 DD	HB215 RM	PC220 DD	PC220 CE	HB215 CE	PC200 RM
Test Sample ID -short	H1DD	C1RM	H2RM	C2DD	C3CE	H3CE	C4RM
Excavator Type	Hybrid	Convntnl	Hybrid	Convntnl	Convntnl	Hybrid	Convntnl
Model	HB215	PC200	HB215	PC220	PC220	HB215	PC200
Owner	RoadMach	RoadMach	DiamondD	Harrison	Clairemont	Clairemont	RoadMach
StateID	DU4Y75	GF3H79	AG8G48	YF3H64	TE4E84	HL4J84	??B37
Test Date	2/28/2013	3/1/2013	3/12/2013	3/13/2013	3/20/2013	3/21/2013	3/21/2013
Test Location	Woodland	Woodland	Woodland	Woodland	Escondido	Escondido	Escondido
Test Operator	DiamondD-1	DiamondD-1	DiamondD-2	DiamondD-2	Clairemont-2	Clairemont-2	Clairemont-2

Note: Data produced by operator "Clairemont-1" was not analyzed due to his extreme inexperience.

Road Machinery provided three of the test units. An HB215LC-1 and PC200 from Road Machinery were tested in Woodland and another PC200 was tested in Escondido. The other two units tested in Woodland were provided by Diamond D (HB215LC-1) and by Harrison Concrete Cutting (HB220), who had rented their unit to Diamond D. The other two units tested in Escondido were provided by Clairemont Equipment (PC220 and HB215LC-1).

As previously mentioned, the dimensions of the excavators and attachments have an important impact on engine loading. Therefore, it is important to establish that all of the units tested of each model are representative of the most popularly sold options and are as similar to each other as possible. We did this in two ways. First we verified with the owner that the test units had the most commonly sold features. Then we measured the dimensions of the test units and buckets as they were prepared for testing. All test units of a given model were essentially identical in dimension and attachment loading. Also, all of the units, no matter their model, used the same size of bucket.

Two test operators were used at the Woodland location, both provided by Diamond D. One operated the PC200 and one of the HB215LC-1s. So the two HB215LC-1 units tested in Woodland were operated by different persons. Since the material and location were the same, this provided data for comparing the impact of different, experienced operators. A single operator, an independent contractor provided by Clairemont Equipment, was used in Escondido to provide data for this report. Another operator had been provided by Clairemont, but the data from those tests was not analyzed due to that operator's extreme inexperience.

### 6.2.2 Test locations and dug materials

As previously described, test locations and materials can have an important impact on engine loads. Therefore, the following list of features were provided to participants as guidelines for finding appropriate test sites:

- The site should be a rectangle approximately 200 yards by 200 yards in area;
- The site should have homogeneous dirt that contains between 10% and 15% moisture down to about 8 feet deep and without rocks larger than gravel;
- The site should not have any underground utilities, and;
- The site should have an approximately level grade with a uniform surface appropriate for moving an excavator easily across.

Emissions tests took place in two locations, one in northern California and the other in southern California. The northern location was near Woodland at the property of Diamond D Engineering and the southern location was near Escondido at the San Diego Zoo Safari Park, where Clairemont Equipment has a multi-year job renting equipment to a park contractor. These locations and the materials moved during testing are described in the following two paragraphs.

Woodland location – The test area was approximately 150 yards wide by 200 yards long. It was next to active agriculture field where oats had been planted. The dirt was a homogeneous loam with sand and clay. According to Diamond D Engineering, its moisture content was approximately 15% and it had a dry bank density of approximately 118 lb/cu-ft. We measured its loose density at an average of 77.5 lb/cu-ft and its shrunk density at approximately 147 lb/cu-ft. Using these values/assumptions, we calculated a conversion constant from bank volume to loose volume of 1.52 (i.e., loose volume = bank volume \* 1.52) which we used when calculating the volume of some of the spoils piles.

Escondido location – The useable test area in Escondido measured approximately 60 yards wide by 80 yards long, which was much smaller than requested. The small size of the test area required that some tests be done in areas that had already been dug. These areas were backfilled and compacted with the test excavators before being re-dug.. When these areas were re-dug, it was done transverse to first digging pass. The material at the site was fill on the side of a hill which had been done years earlier to make room for overflow parking at the park. The fill material was similar the material at the Woodland test site, but slightly lower in moisture content and slightly higher in sand. It had a loose density averaging 84.5 lb/cu-ft. The estimated conversion constant from bank to loose volume was the same as had been calculated for the Woodland site (i.e., 1.52). At one end of the test area the fill only extended to a depth of about 3 feet. Below that was a tough to dig decomposed granite layer. When test digging encountered the decomposed granite, the trench was allowed to be dug to a slightly shallower depth and longer length, but only up to a minimum trench depth of about 4 feet.

### 6.2.3 How testing was conducted

Tests were always done in the same way. Each test mode was performed in the same order and using the same techniques as much as possible. In some operations the operator technique played a significant role. This was especially true of the “Dress” and “Backfill” modes. Therefore, it was important to determine how each operator was comfortable performing each of the modes in advance of testing. Then during testing, the operator was to use the same, pre-agreed techniques for each test replicate.

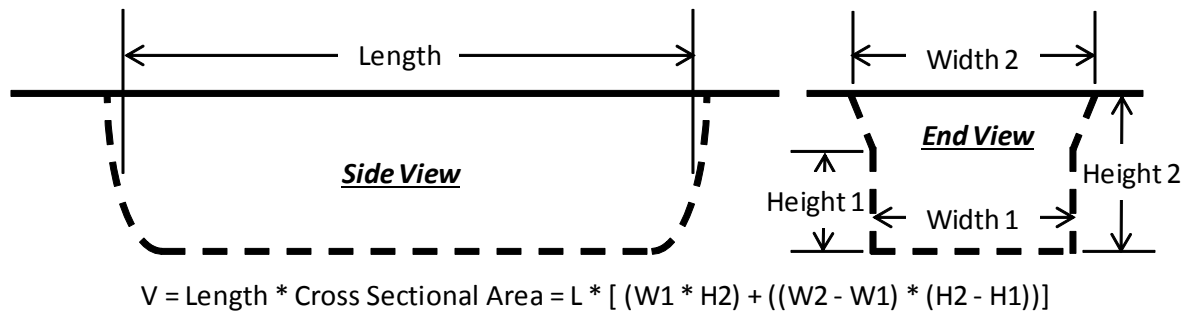
The order of the test modes and notes for how they were to be performed are shown in Table 6-10. Each replicate of the test took less than 60 minutes to perform.

**Table 6-10 Order of test modes with methods and notes**

Test Order	Mode Name	Description
1	Prepare for Travel	Move to start position. Make sure excavator is in "Power" mode.
	Travel	Travel back and forth three times, 100 yards in each direction. Use "Slow" speed setting the first lap, "Medium" the second, and "Fast" the third. Turn as normal for operator at each end.
2	Prepare for Trench 45	Idle for 30 - 60 seconds. Move to start for next mode. Idle for 20 - 30 seconds.
	Trench 45	Dig a level trench 1 bucket wide & 4 to 5 feet deep for 8 minutes. Swing 45° & drop spoils in a row on one side. Clean the top sides as you go for safety.
3	Prepare for Trench 90	Idle for 30 - 60 seconds. Move to start for next mode. Idle for 20 - 30 seconds.
	Trench 90	Dig a level trench 1 bucket wide & 4 to 5 feet deep for 8 minutes. Swing 90° & drop spoils in a row on one side. Clean the top sides as you go for safety.
4	Prepare for Trench 180	Idle for 30 - 60 seconds. Move to start for next mode. Idle for 20 - 30 seconds.
	Trench 180	Dig a level trench 1 bucket wide & 4 to 5 feet deep. Swing 180° & drop spoils in a pile behind. Clean the top sides as you go for safety. Stop when the treads start to climb the spoils pile (about 6 minutes).
5	Prepare for Dress	Idle for 30 - 60 seconds. Swing 180 degrees to dress the spoils from the "Trench 180" mode.
	Dress	Using a pre-determined technique that is natural to the operator, dress the "Trench 180" spoils pile evenly down to a level of about 1 foot high. Stop when the entire pile is done.
6	Prepare for Backfill	Idle for 30 - 60 seconds. Travel back to the "Trench 45" spoils row. Idle for 20 - 30 seconds.
	Backfill	Using a pre-determined technique that is natural to the operator, backfill the "Trench 45" trench using the spoils that came from it. Stop when the trench is level to the ground.
7	Idle	The data for this mode will be assembled during post processing from the times in between modes 1 through 6.

The above tests were performed in triplicate. During each test the data were observed remotely to allow immediate correction of any problems. Also, a person was stationed near the excavator to oversee its operations, to indicate the beginning and end of each mode to the operator, and help the operator remember to use the pre-agreed techniques and the proper sequence of events. As the end of each mode approached, the person stationed near the excavator would remind the operator to finish the trench soon and the operator would do so in the pre-agreed manner. The uniform ending of trench digs allowed a more precise measurement of trench dimensions.

As each test was conducted, the dimensions of the trench dug during the previous mode were measured so the volume of bank material removed could be calculated. The sketch in Figure 6-26 shows how the dimensions were recorded. The length of a trench was measured between the half-way points of the slopes on each end. Because the cross-section of a trench is not uniform from bottom to top, the depth and width of the trenches were measured in two stages. First the bottom width was measured (Width1 in the figure) and the average height to which that width extended up the wall of the trench was measured (Height1 in the figure). Then the average top width and the overall height of the trench walls (i.e., its depth) were measured. For the purposes of computing trench volume, the slope of the trench wall between the bottom width and the overall (top) width was assumed to be a straight line. The final volume of the trench was calculated as its length times its average cross-sectional area.



**Figure 6-26 Measurement of trench dimensions**

At the end of each test the data quality was given an initial check, and if necessary the particulate filter was changed. This process was repeated until valid, comparable triplicate tests for each unit had been completed.

#### 6.2.4 Analysis

At the end of each test day, the field data were reduced and quality assured to produce preliminary results. All exhaust measurement, engine parameter and GPS data were reduced and reviewed. Also, the engine brake torque for each second was calculated using lug curves previously obtained or estimated from manufacturer information. These field results did not include the gravimetric particulate data, but they did include the real-time (photo-acoustic) particulate measurement. In addition to data for the test unit, data measured from the trenches and spoils piles were also reduced to yield trench and pile volumes.

The quality assured field data were then briefly compared to previous results to check consistency. When the gravimetric PM samples arrived back at UCR, they were acclimated back to the conditions of the weigh room and then given their post-test mass measurement. The gravimetric results were then used to calculate a final second-by-second particulate signal and the final particulate data were calculated for each test.

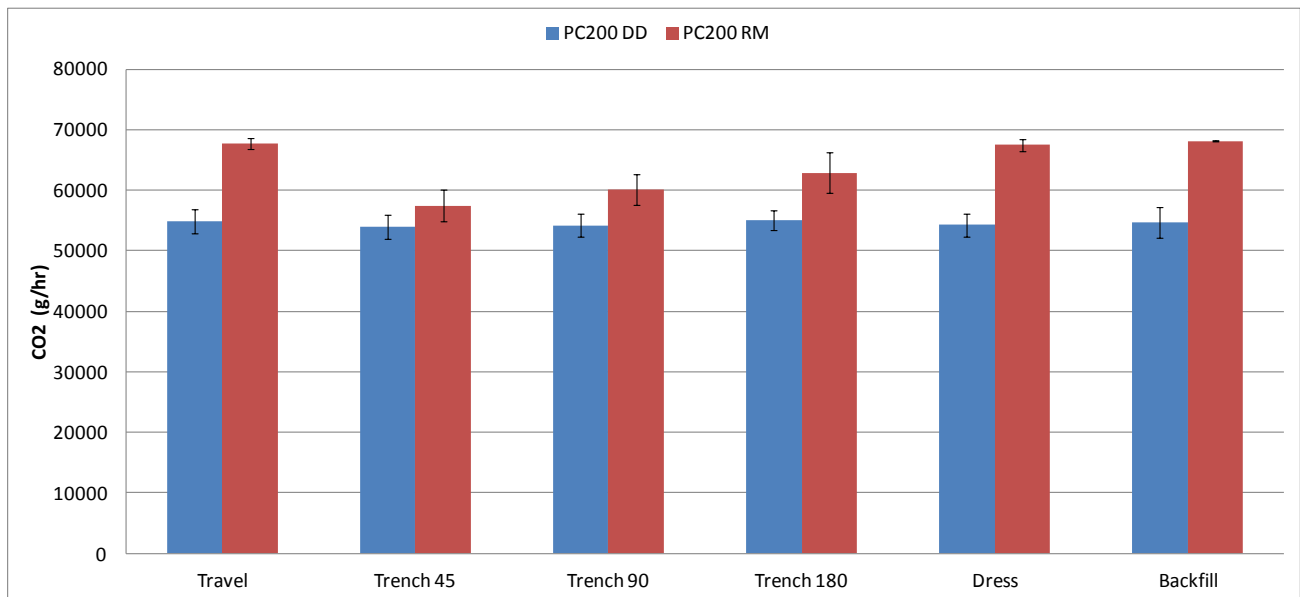
When all of the quality assured data had been finalized for each test unit, the means, standard deviations of the underlying data, the coefficient of variation, and the standard error of the means were all calculated for each pollutant and important engine parameters for the triplicate data from each unit. These means were then compared to those from other units to determine the approximate impacts of operator technique, soil differences, and to estimate the benefits and dis-benefits of using the hybrid excavator as opposed to the other two models of conventional excavator.

#### 6.2.5 Controlled in-service results

For all the excavator testing controlled amounts of material were moved and quantified. This made the excavator comparisons directly comparable for all activities and modes evaluated. Multiple versions of each model of excavator were tested, so in this section we first inter-compare the same model of excavator to each other. This gives us the chance to discuss normal, in-use variability in results and the influence of operator differences. Then we discuss how the hybrid HB215 compares to the PC200 and to the PC220. The following data is thus presented for the excavator data primarily on a g/ton and g/hr basis

## PC200 Excavators

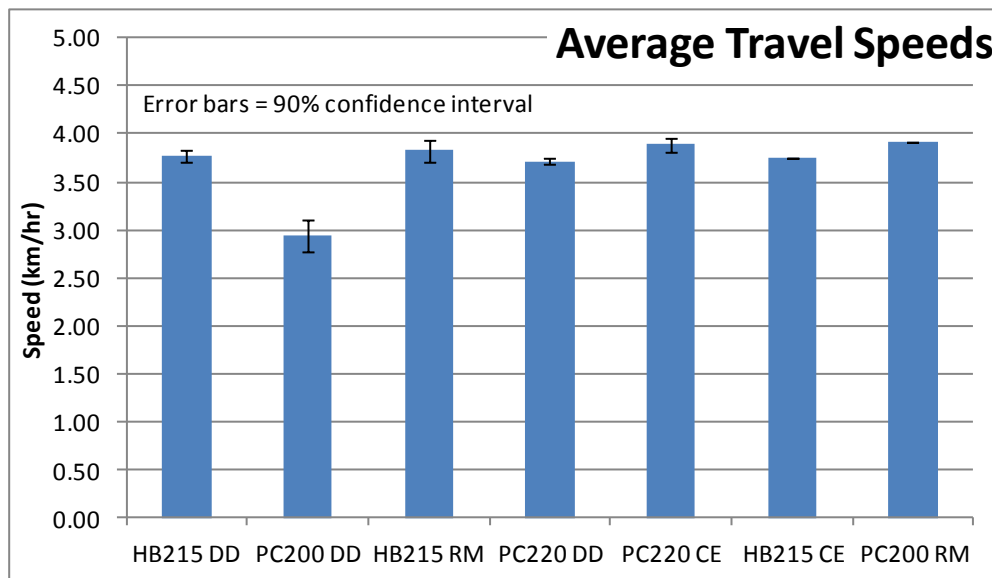
Two PC-200 excavators were emissions tested, one at the Woodland site and the other at the Escondido site. The column chart in Figure 6-27 compares the mean CO<sub>2</sub> results from those tests with the unit tested in Woodland (PC200 DD) represented by the blue columns.



**Figure 6-27 PC200 CO<sub>2</sub> modal test results**

CO<sub>2</sub> emissions directly correlate to fuel consumption rate and it can be seen that these units have a significantly different rate of fuel consumption, particularly during the “travel mode and the modes that involve a lot of maneuvering (dress and backfill). It is not obvious why these excavators would have such different fuel consumption rates. They were tested at different locations and operated by different persons, but as will be seen with the other models, those should not account for this difference. One possible effect that might help explain the fuel consumption difference is that the operator noticed that the treads for the unit tested in Woodland needed maintenance. This is explained further in the next paragraph.

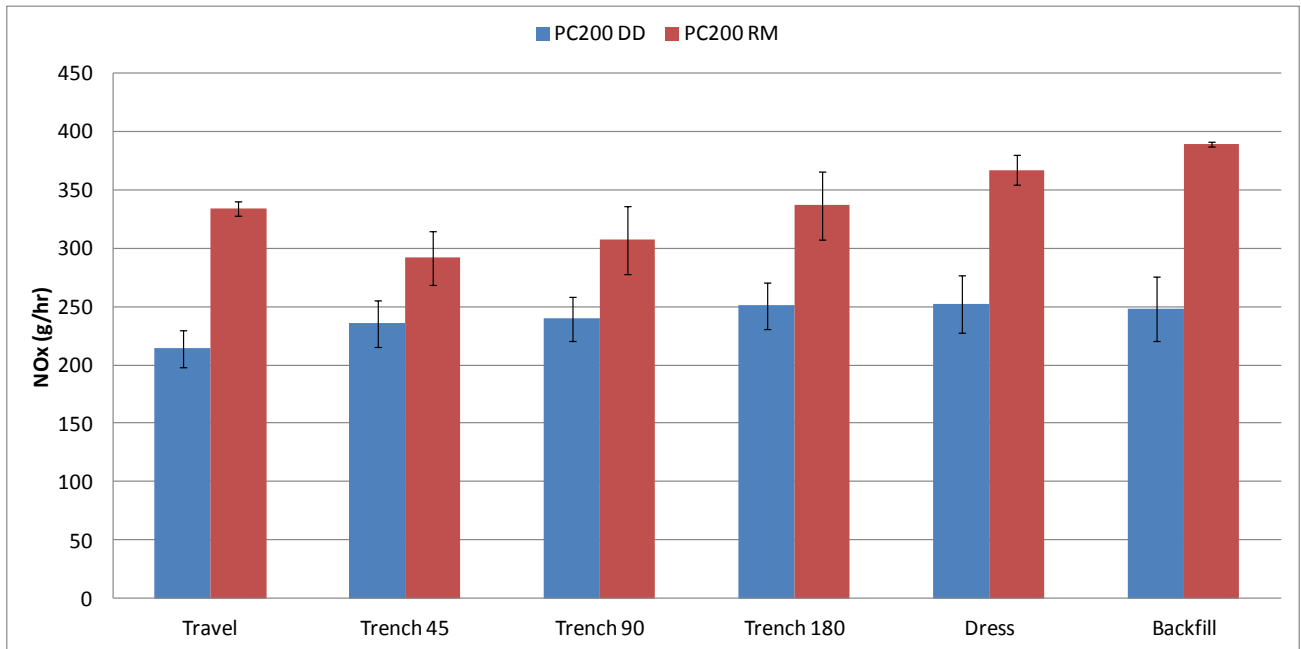
To investigate a possible reason for the different CO<sub>2</sub> emissions from the two PC200s we looked at the speed of travel of all of the excavators. We reasoned that if the treads were in need of maintenance (as the operator said), their “tightness” may be reflected in travel speed and different fuel consumption rate due to higher tread friction. Also, we had noticed that the first PC200 tested (at Woodland) seemed to travel significantly slower than the other excavators. So to look for empirical support of the anecdotal observation we plotted the travel speeds of the excavators to compare them, as shown in Figure 6-28.



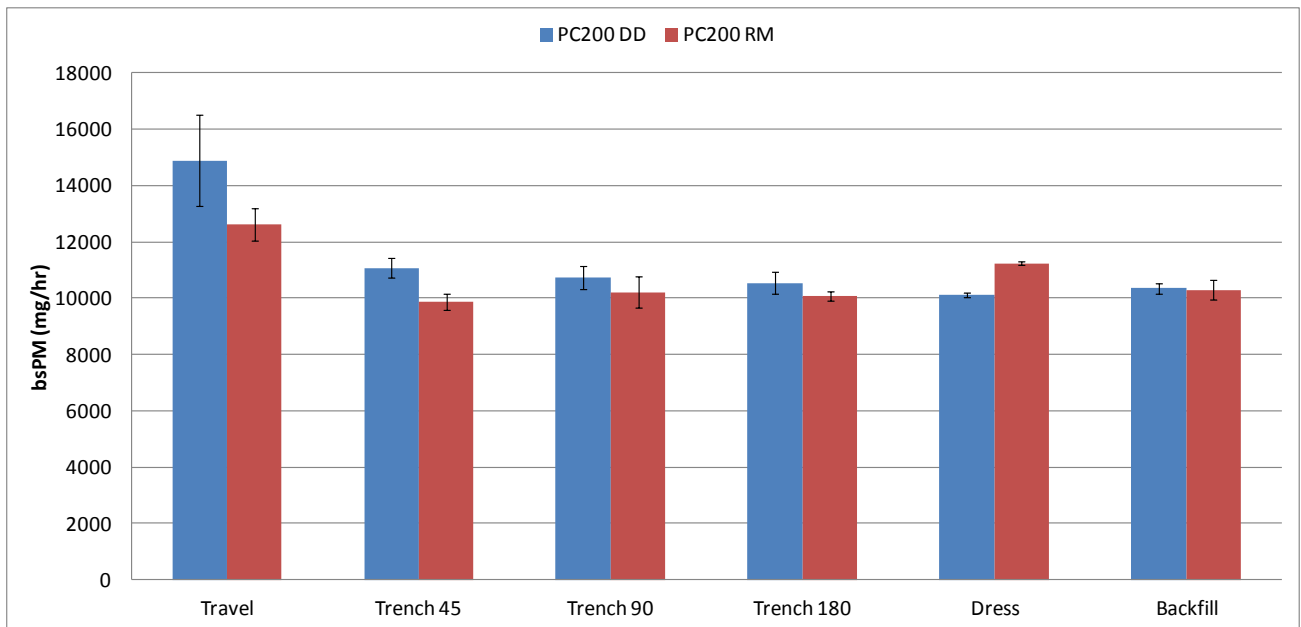
**Figure 6-28 Average travel speeds of excavators**

The error bars in Figure 6-28 show the 90% confidence interval for the means and it is obvious that the PC200 DD did travel significantly slower than the other excavators. According to Diamond D Engineering, the significantly lower travel speed of the PC 200 excavator tested at the Woodland location was most likely caused by “tight” pads on its tracks. This is a condition caused by high wear and binding in the pinned joints between the track pads. This condition typically precedes having to repair or replace the excavator treads. However, this result does not necessarily confirm that tighter treads means significantly different fuel consumption because we expected the higher friction of the treads to result in a higher fuel consumption rate. But as can be seen in the CO2 emissions result, PC200 DD actually has a significantly lower fuel consumption rate during travel and modes that involve more maneuvering. Since the results were inconclusive, and we could not classify PC200 DD as an outlier data point, we left the test results for PC200 DD in the data set.

The graphs in Figure 6-29 and Figure 6-30 show how NOx and PM emissions varied between the PC200 units. NOx emissions from the PC200 DD unit were very consistent from mode to mode as compared to the PC200 RM unit (and the other excavators as well). This lends more weight to an argument that the PC200 DD unit was not operating as it should. However, given the fact that the sample size is low and we do not have definitive reasons to exclude the data from PC200 DD we recommend keeping the data from that unit as representative of normal variability that would be found in test results for “in-use” excavators.



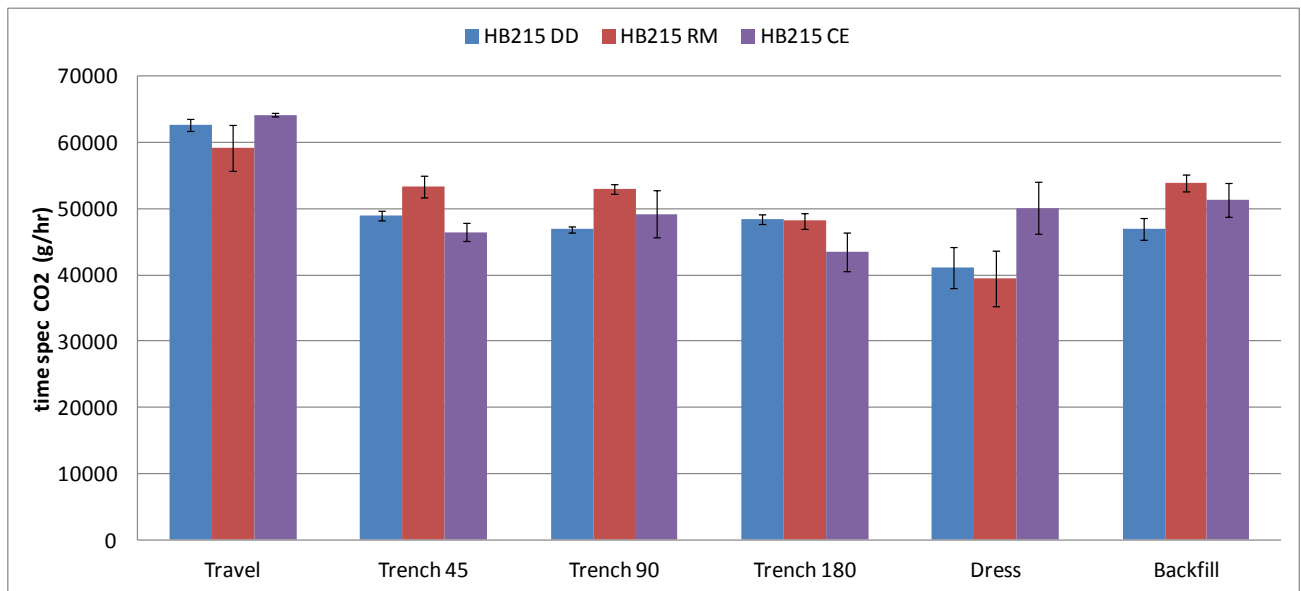
**Figure 6-29 PC200 NOx modal test results**



**Figure 6-30 PC200 PM modal test results**

*HB215LC-1 Excavators*

Three HB215LC-1 excavators were tested in the project. Two were tested in Woodland (the same material but operated by different persons) and the third was operated by a third operator in Escondido. The column graph in Figure 6-31 compares the average CO<sub>2</sub> emissions from those three hybrid units. To give an idea of test variability, the error bars in these graphs are one standard deviation of the triplicate results for each unit.

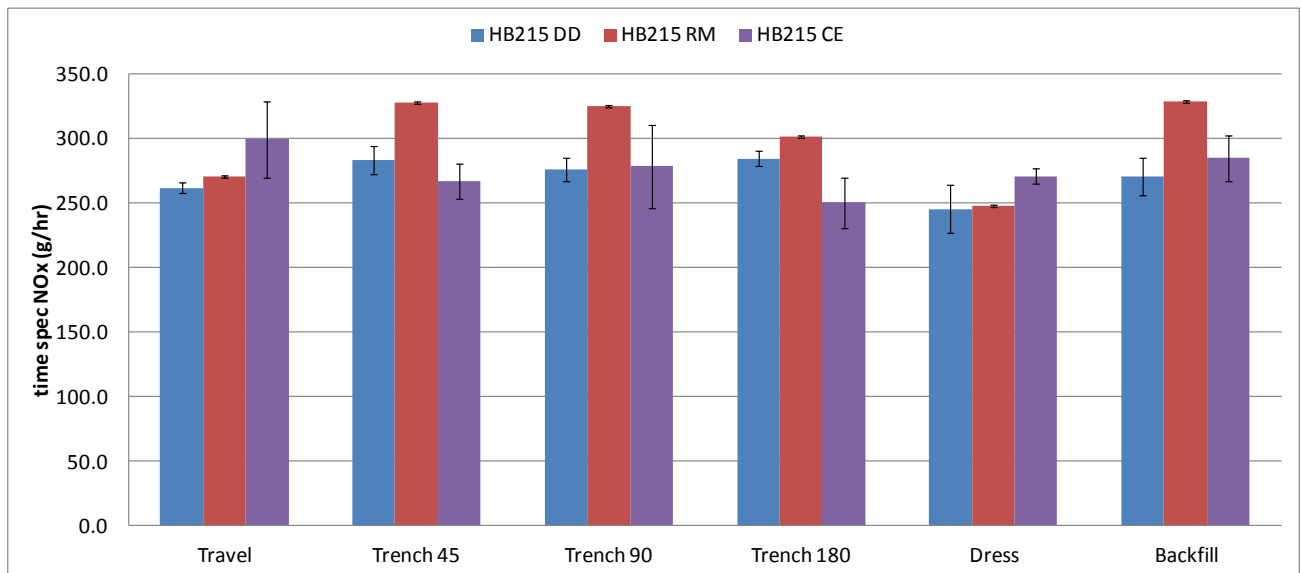


**Figure 6-31 HB215 CO2 modal test results**

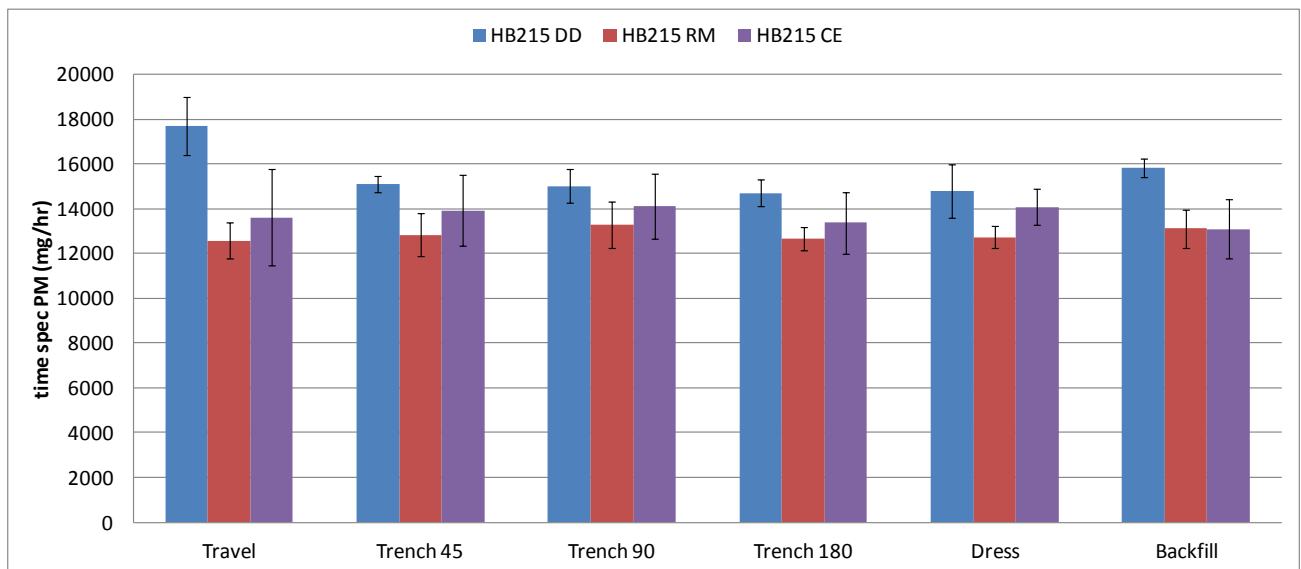
The column graph of CO2 results for the three hybrid units show that in spite of being operated at different sites and by different operators, they have very similar fuel consumption rates for the same job. The error bars represent one standard deviation of the data behind the means and they show very small variation in the triplicate data behind each mean, except in a few instances – particularly the “dress” mode. This result is interesting since the techniques of the different operators and the material they were working in seemed much more different than these results imply. While we hesitate to draw too broad of conclusions from such a small data set, these tests seem to indicate that in spite of differences in operator technique, in-use testing of excavators could prove to be a valuable source of data that regulatory decisions could be confidently drawn from. We discuss operator differences in more detail in section 6.2.6.

The following two graphs (Figure 6-32 and Figure 6-33) show the means and standard deviations of the triplicate tests for NOx and PM emitted by the hybrid units. As was the case for the CO2 results, the variability of the data are shown to be quite low considering the nature of NOx and PM emissions from diesel engines. Qualitatively speaking, we expected the NOx and PM emissions to have significantly more variability than these results show.





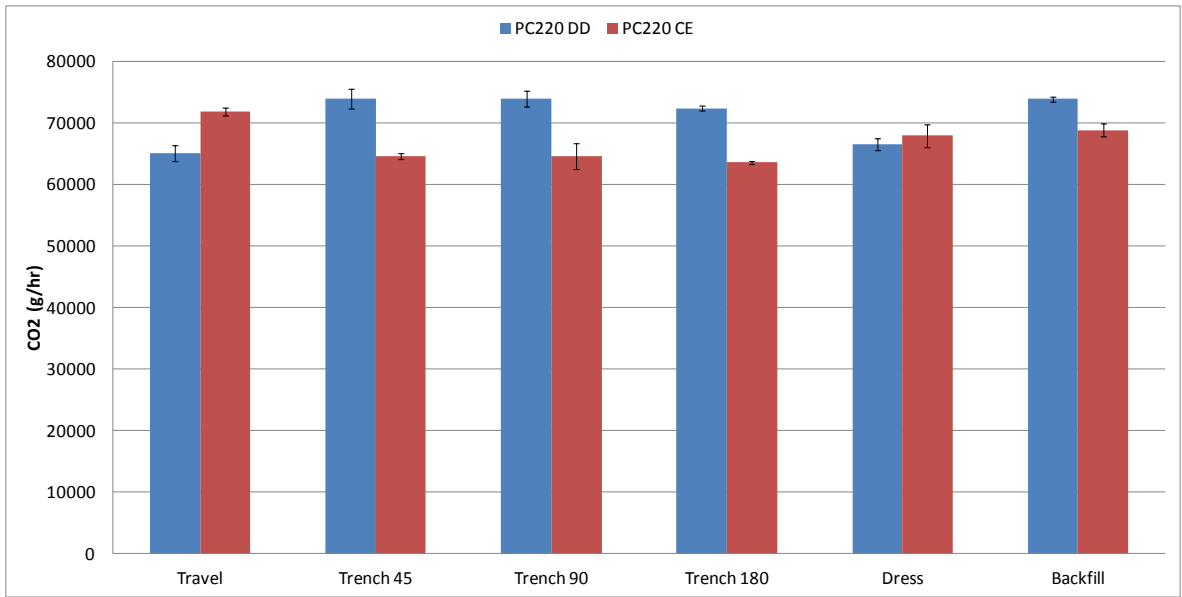
**Figure 6-32 HB215 NOx modal test results**



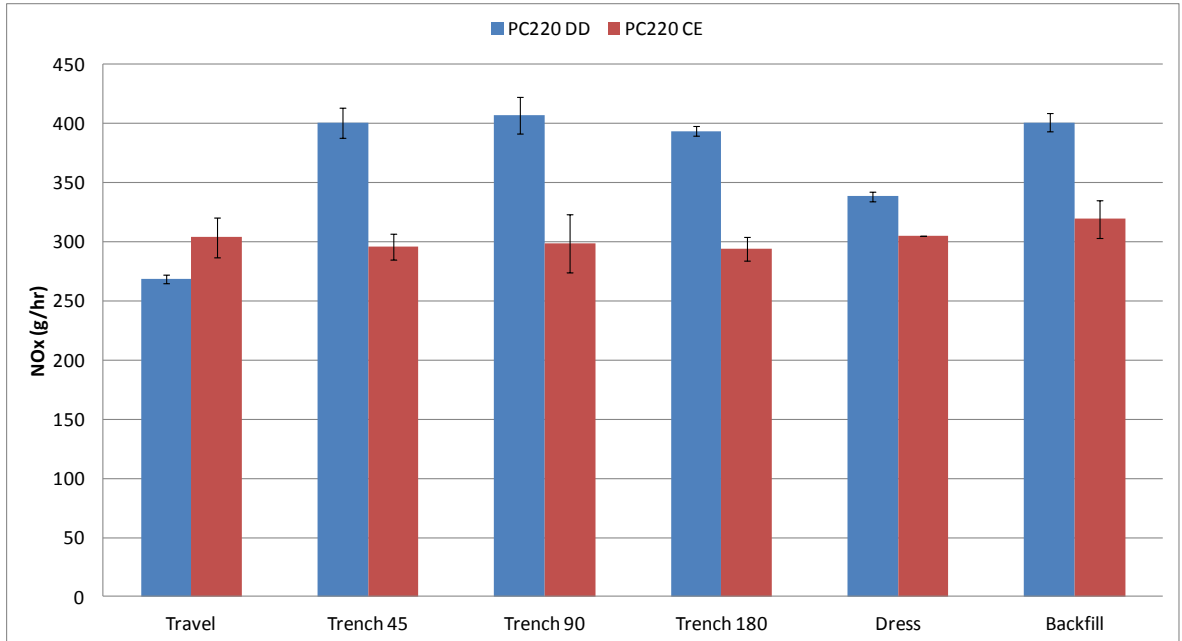
**Figure 6-33 HB215 PM modal test results**

### *PC220 Excavators*

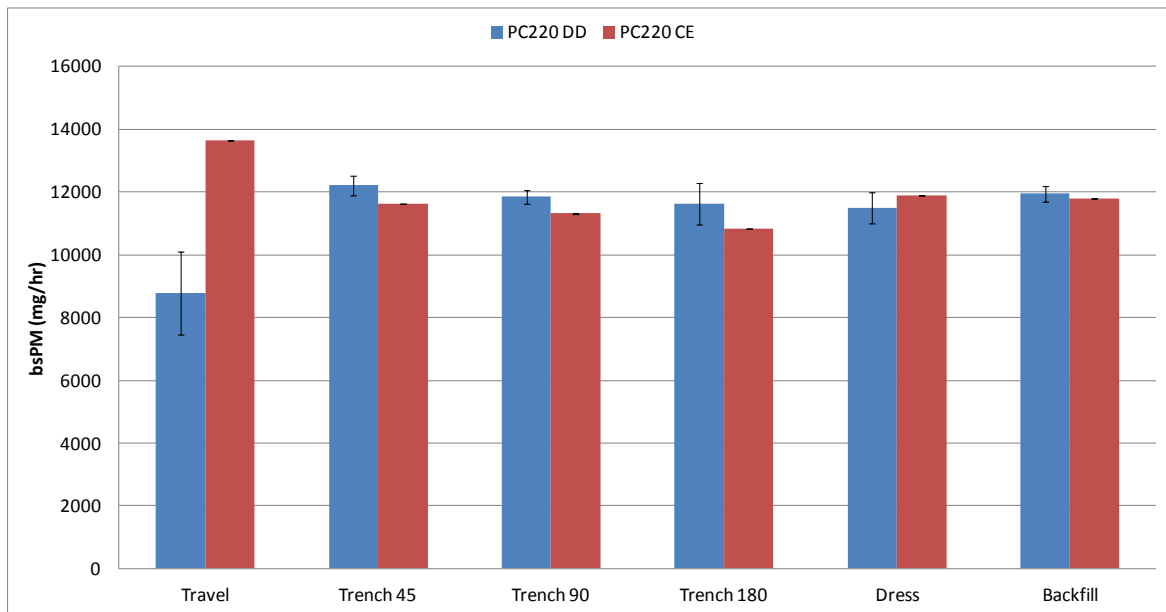
Two PC220 excavators were tested for the project, one at the Woodland site and the other at the Escondido site. They also were operated by different persons. As we did for the other models, below we show a series of graphs that compare the mean emissions for CO<sub>2</sub>, NO<sub>x</sub>, and PM for these units. Similarly to the previous comparisons, these results show a surprisingly low amount of test to test variability.



**Figure 6-34 PC220 CO2 modal test results**



**Figure 6-35 PC220 NOx modal test results**

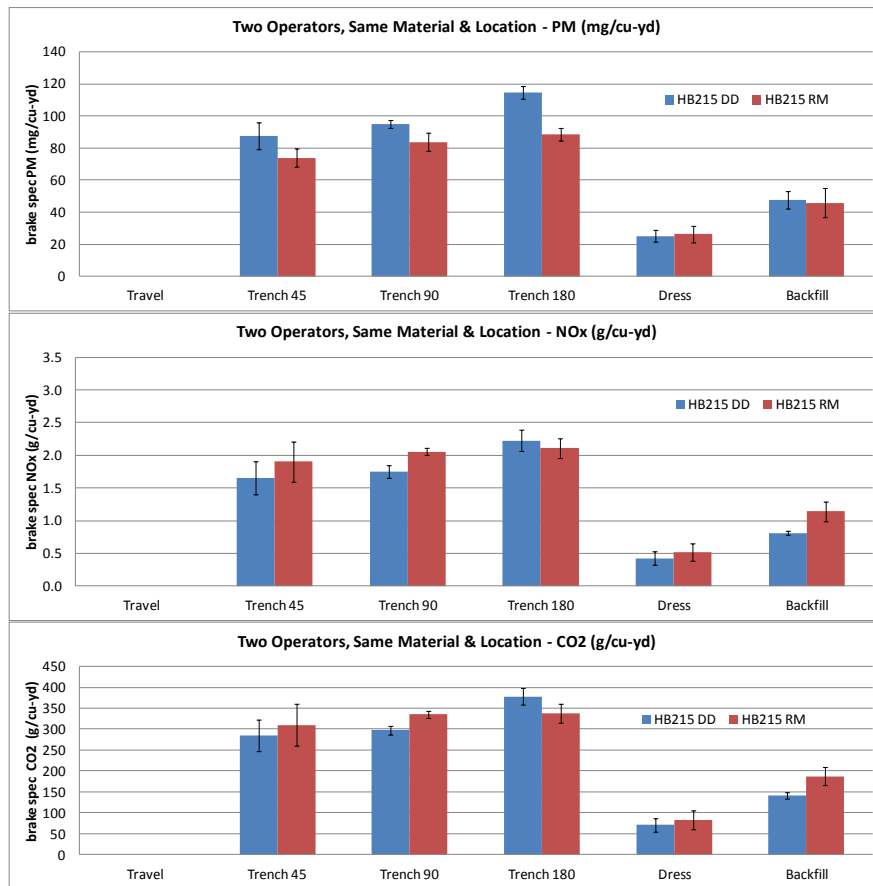


**Figure 6-36 PC220 PM modal test results**

### 6.2.6 Operator differences

Two HB215LC-1 excavators were tested at the Woodland location on the same material, but while being operated by different persons. We compared the data from those tests directly to each other to get an idea of the influence of operator style on fuel consumption and emissions.

Although both were experienced operators, one was acknowledged by his boss to have a smooth and methodical style of operation while the other was seen as being aggressive and quick. Each operator performed the emissions test in triplicate. The results were averaged and are presented for each mode of the test (except for the ‘travel’ mode, which was not significantly influenced by operator technique) below in Figure 6-37. They are shown on a basis of “emissions per unit of material moved” (e.g., g/cu-yd). Results for the “travel” mode are not shown since they don’t make sense when expressed in these units and the operator has little opportunity to influence the travel mode emissions (all the operator does is turn at each end of the 100 yard runs). Since typical excavator jobs are to move a specific amount of material (e.g., dig a trench of specific dimensions), presenting the results on this basis is similar to presenting them on a “per job” basis.

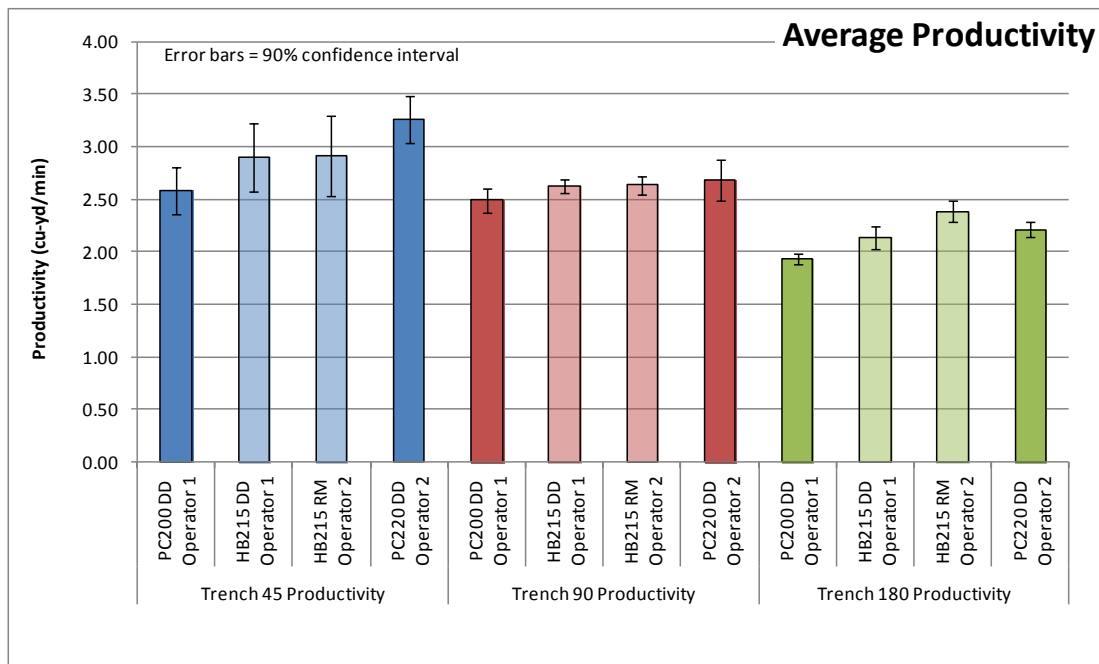


**Figure 6-37 Operator Influence on Emissions per Job**

Although we confirmed through observation that the first operator was much smoother and less aggressive than the second one, the emissions differences between their operation styles were not dramatic for the hybrid excavator. Even when the results are also shown in terms of time-specific emissions (not presented here), the same conclusions are drawn. Using the same model of hybrid excavator in the same material, but in spite of what seemed to be significantly different operating styles, the two experienced operators at the Woodland site had similar fuel consumption rates and similar pollutant emissions for the same job.

Having two operators working at the same location with a variety of excavator models also allowed us to compare the relative productivity of the operators and the equipment. There has been speculation among the hybrid users that it may be more productive for certain types of work that involve lots of swing, such as dressing, 180 degree trenching, etc.

The graphic in Figure 6-38 shows the average productivity during the three trenching operations for the equipment and operators as tested at the Woodland location. Productivity is in terms of “cubic-yards of material dug per minute” and the operations are trenching with 45 degree swing (blue columns), with 90 degree swing (red columns), and with 180 degree swing (green columns). The error bars show the 90% confidence interval of the means. One operator used the PC200 and one of the HB215LC-1s and the other operator used the other hybrid and the PC220 (which is a slightly larger machine). As previously mentioned, all models had their “stock” boom and stick and were using the same bucket.



**Figure 6-38 Productivity of different operators and excavator models**

For a given operation, the operators seem to have almost identical productivities. This is shown by the fact that the two hybrid excavators (the middle two columns in each mode) have essentially the same productivity for a given operating mode, even though they are being operated by different persons.

For all models, as the amount of swing increased, the average productivity decreased. This makes sense because with larger swing, more time is spent moving dirt from the trench to the pile and less time is spent digging. Also, for a given operation, the PC200 was less productive than either the HB215LC-1 or the PC220. But as the amount of swing increased, it seems like the productivity of the hybrid becomes closer to the productivity of the PC220. This supports the anecdotal observations of the operators who suggest the hybrid is more productive for jobs with more swing and it also argues for the possibility that for certain types of work, the HB215LC-1 may be a good replacement for the PC220, in spite of the fact that the PC220 is a slightly larger machine.

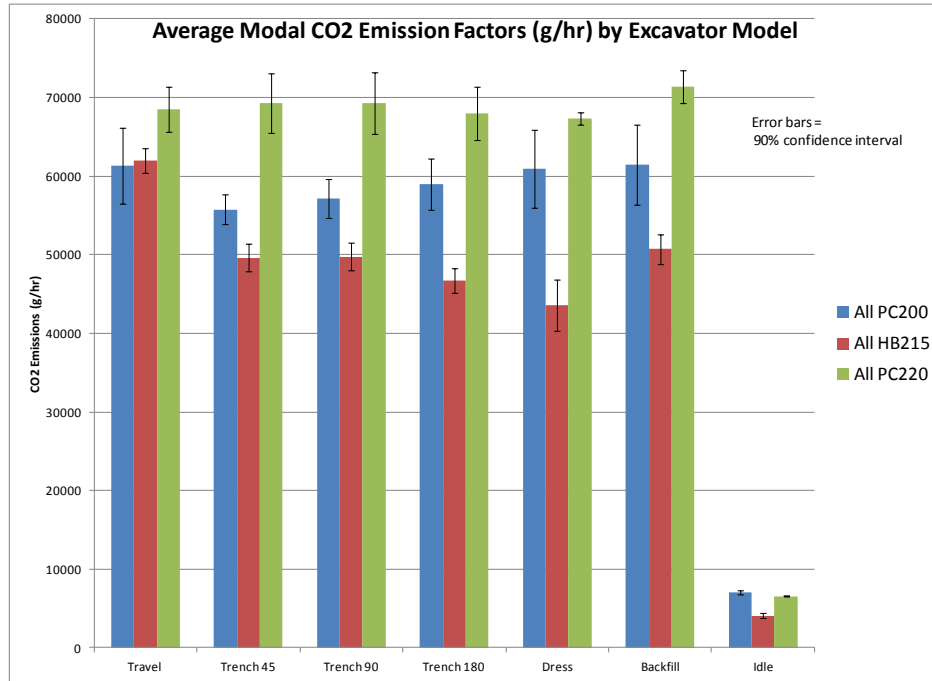
#### 6.2.7 Average Modal differences: HB215 vs PC200 vs PC220

Comparing the combined, averaged results for each mode of the test reveals strengths and weaknesses of each model of excavator when it comes to fuel consumption and emissions. Below we compare the results for CO<sub>2</sub> emissions (i.e., fuel consumption), NO<sub>x</sub>, and PM emissions for the average results from each model. In other words, the HB215 is compared to both the PC200 and the PC220.

CO<sub>2</sub> emissions serve as an analog of fuel consumption because, for all practical purposes, 100% of the CO<sub>2</sub> emitted from the engine comes from the carbon in the fuel, and for diesel engines practically all of the carbon in the fuel is converted to CO<sub>2</sub><sup>9</sup>. The CO<sub>2</sub> emissions for each mode of the test and each model of excavator are compared in the graph of Figure 6-39. The emissions of NO<sub>x</sub> and PM are similarly compared in Figure 6-40 and in Figure 6-41 immediately following. The

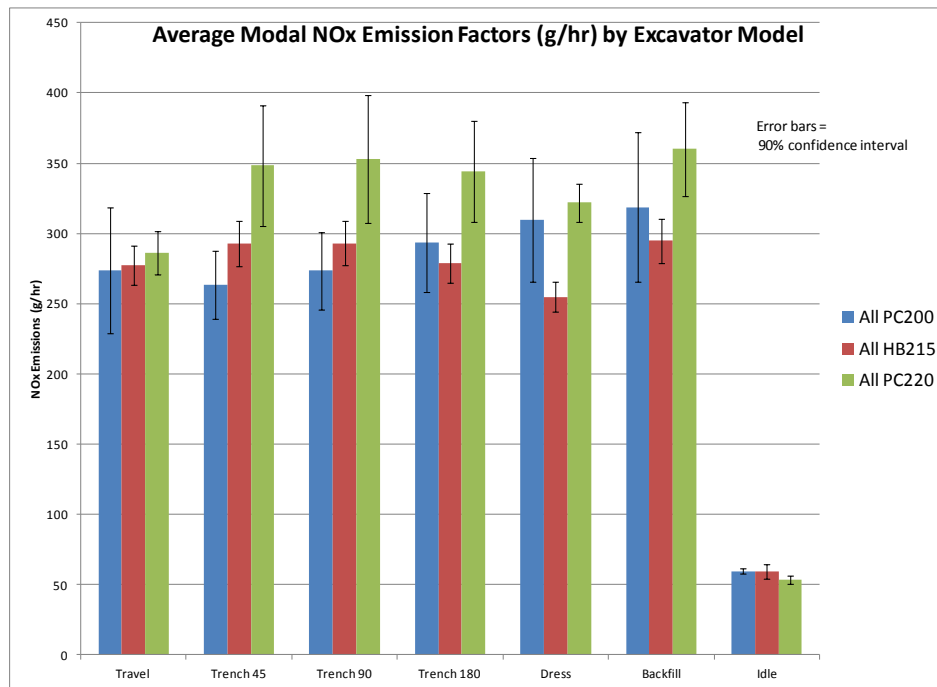
<sup>9</sup> Negligible amounts of fuel carbon are not fully combusted and are emitted as either particulate matter, CO, or hydrocarbon. But the mass of carbon in these emissions is negligible when compared to that from CO<sub>2</sub> emissions.

three figures compare models side by side for each mode. The left (blue) column represents the PC200 result, the middle (red) column represents the HB215LC-1, and the right (green) column represents the PC220. The error bars in these graphs show the 90% confidence interval for each mean.



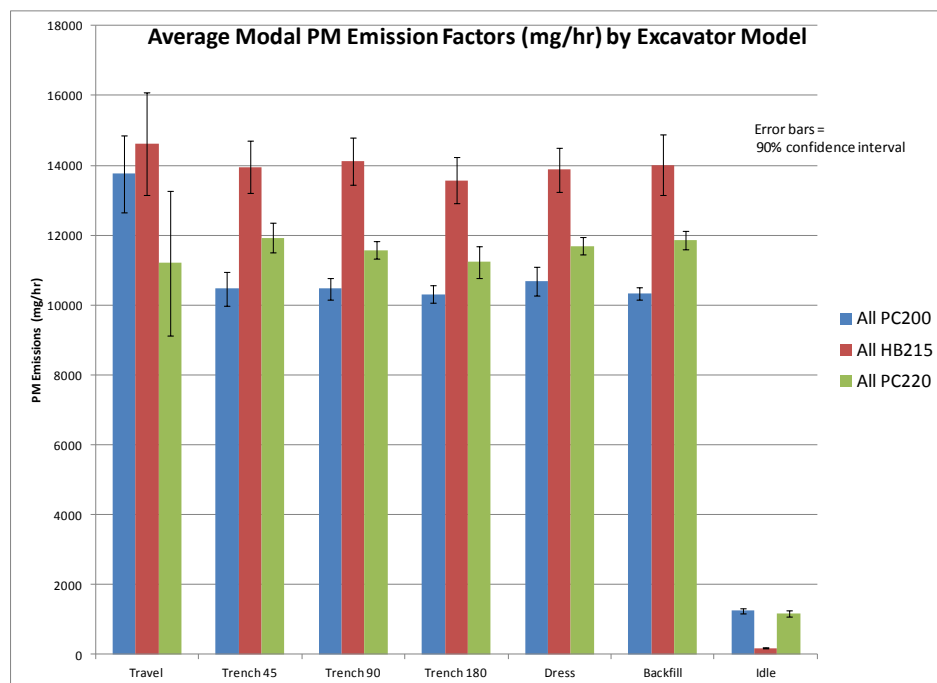
**Figure 6-39 Average modal CO2 (fuel consumption) differences between excavator models**

For fuel consumption, the HB215LC-1 is consistently more efficient than either of the conventional excavators, except during the travel mode, where it consumes about the same amount of fuel as the PC200. Since travel mode is not prevalent in typical excavator work, these results indicate that the hybrid excavator will use consistently less fuel for a given time of work. This translates to less fuel per job for the hybrid because these excavators are similarly productive.



**Figure 6-40 Average modal NOx differences between excavator models**

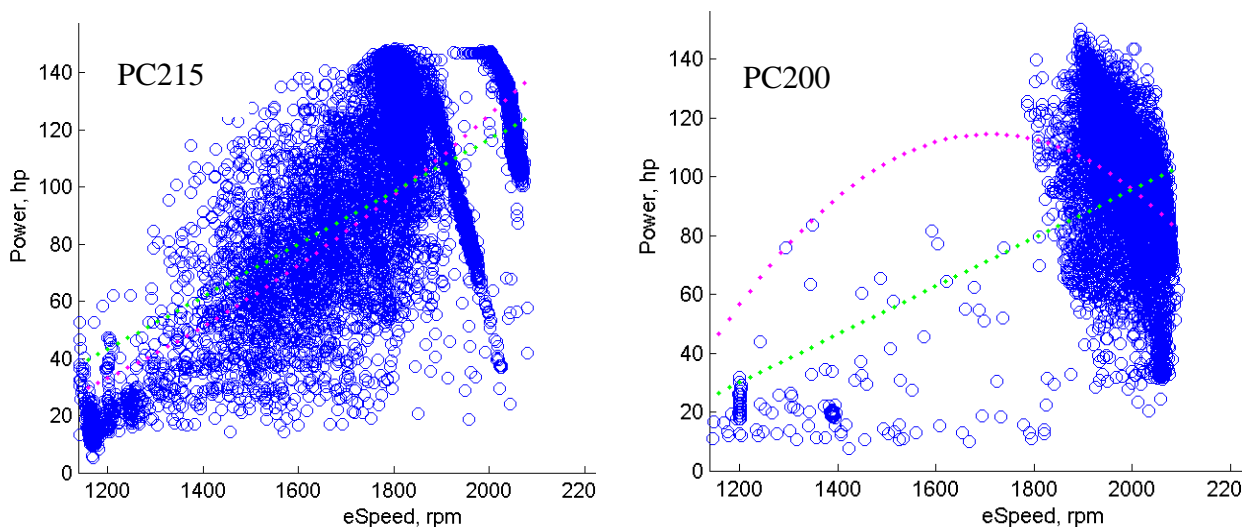
NOx emissions from the HB215 and the PC200 are similar for the different modes of work, but those from the PC220 are consistently higher than from either the HB215 or the PC200.



**Figure 6-41 Average modal PM differences between excavator models**

Particulate emissions from the HB215LC-1 are consistently higher than from either of the conventional excavators for all modes of work except the idle mode. These results were confirmed by visual observation of the plume from the exhaust pipes of these units. The HB215LC-1 models all had more visible plumes than the two conventional units. A possible explanation for the higher PM emissions from the hybrid is suggested by the comparison of second-by-second engine power

versus engine speed for the hybrid HB215LC-1 and the conventional PC200 (see Figure 6-42). The plot for the hybrid is on the left and that for the conventional is on the right.



**Figure 6-42 Engine load as a function of engine speed for the HB215LC-1 and PC200**

The power output of the hybrid's engine (left plot) can be seen to vary significantly over a much wider range of engine speeds than the engine in the conventional excavator (right plot). The PC220 had a similar plot as the PC200. From previous test experience we know that abrupt engine speed changes under load often lead to higher PM and CO emissions from diesel engines. We observed during emissions testing that the hybrid excavator engine speeds changed quite rapidly as the engine was loaded during various operations. So we suspect that if the engine calibration were to be changed to decrease the severity of these engine speed changes under load, both the PM and CO emissions from the hybrid would be significantly decreased. Judging from previous work in this area, we speculate this could be accomplished with little impact on fuel consumption and NOx emissions.

### 6.2.8 Facility differences (soil compaction and density)

Two sites were used for testing, one in Woodland and the other in Escondido. The material the test excavators moved at these sites were different.

The Woodland site was at also the site of a working farm. The dirt at the Woodland site was sandy loam near the surface. Starting about 8 feet deep, a layer of pea gravel mixed with the loam was encountered. However, the gravel was hardly ever included in the material moved during the tests that provided data for this report.

The Escondido site was on dirt fill that had been used to create a level area for a temporary overflow parking area at the Wildlife park. Below that fill was the side of a hill that was densely packed decomposed granite (DG). One end of the parking area was lower than the other. The lower end of the test area had about 8 feet of fill and the upper end of the site had about 4 feet of fill. When the excavator bucket encountered hard packed, DG during a test, it would simply dig a slightly longer trench rather than attempt to dig the same depth in the much harder material.

We decided not to attempt to assess the possible impact of differences in materials from the two sites on emissions. Our reasoning was that the different operators at the two sites would have had a relatively large and undeterminable impact on any observed differences.



### 6.2.9 Overall benefit

Having considered the possible range of emissions differences between the hybrid and conventional Komatsu excavator models, it is possible to present a range of benefits (or dis-benefits) of purchasing the hybrid instead of either the smaller PC200 or the larger PC220. Table 6-11 summarizes these ranges. The extremes of the ranges are a weighted average of the modal distributions observed in the construction activity data and those observed in the demolition activity data. The assumption that these types of work represent the extreme is reasonable since weighting them according to industry assumptions<sup>10</sup> gives estimates in between those in the table.

**Table 6-11 Range of overall benefits of HB215 relative to conventional**

	CO2 (g/hr)	NOx (g/hr)	PM (mg/hr)	THC (g/hr)	CO (g/hr)
PC200 (Tier 3)	-13% to -23%	4% to -12%	27% to 26%	-68% to -70%	10% to 7%
PC220 (Tier 3)	28% to 31%	15% to 18%	-19% to -15%	73% to 74%	0% to 12%

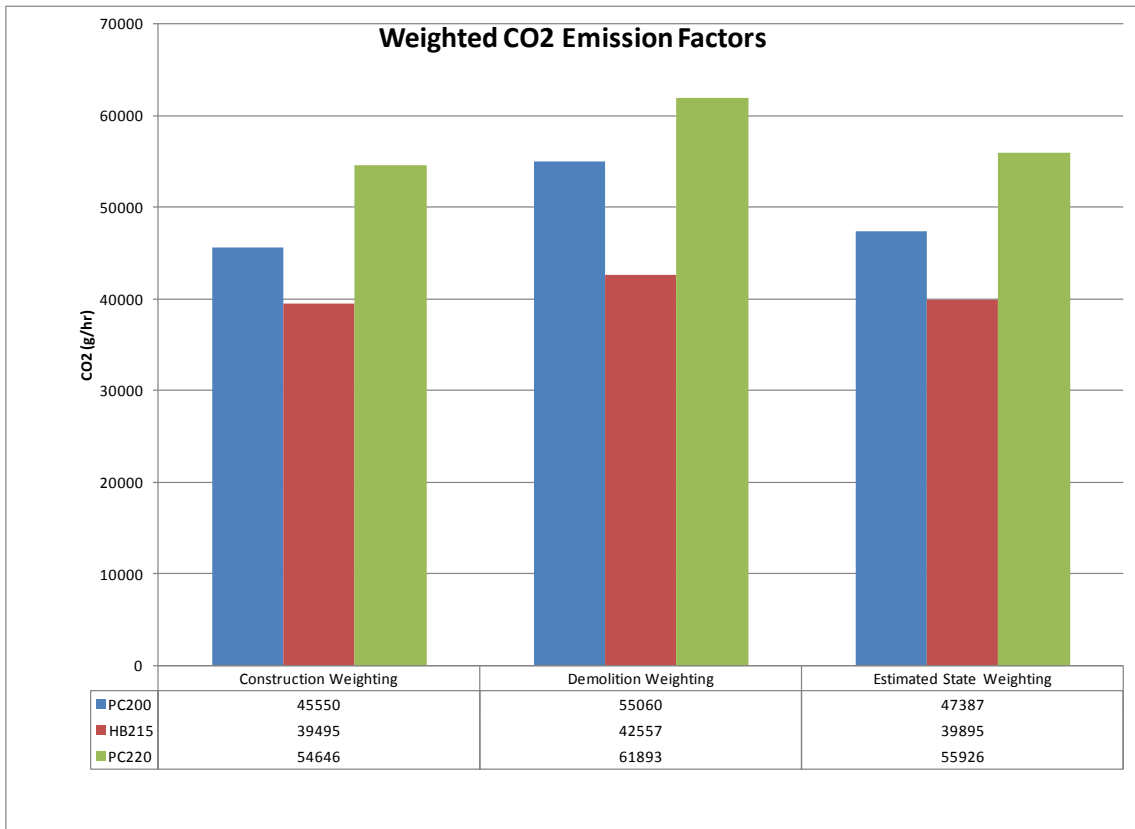
Notes: - Range extremes are "construction only" and "demolition only."

So, for example, by purchasing an HB215LC-1 instead of a PC 200, the typical excavator owner could expect to save from 13% to 23% in fuel (a benefit), but would emit from 26% to 27% more PM (a dis-benefit) in doing so. The expected ranges depend upon whether the excavators would be used more for construction type of work or more for demolition type of work.

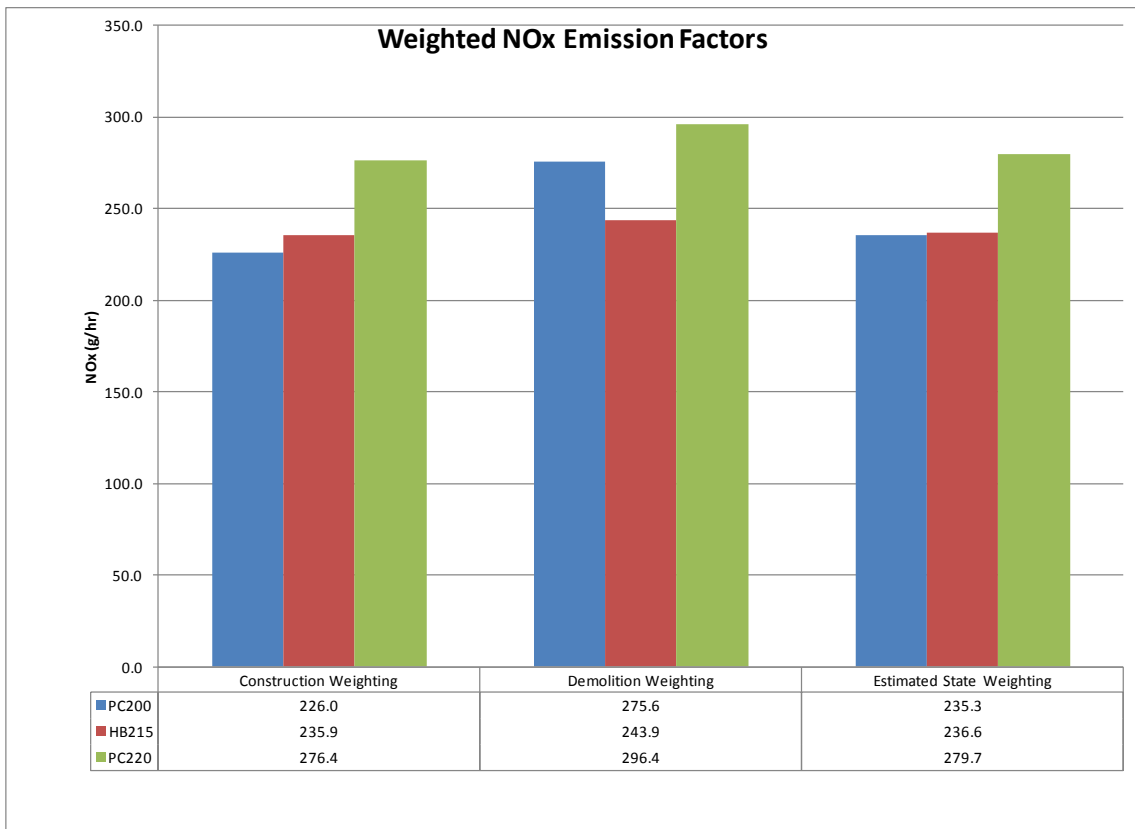
By looking at the emissions levels graphically, we can get another view of these differences. The series of column graphs in Figure 6-43 through Figure 6-45 show the variation in average CO<sub>2</sub>, NO<sub>x</sub>, and PM emissions for the three models of excavators when a construction weighting, and demolition weighting and a state-average weighting is assumed for their usage patterns (as developed using the activity data and from expert interviews).

---

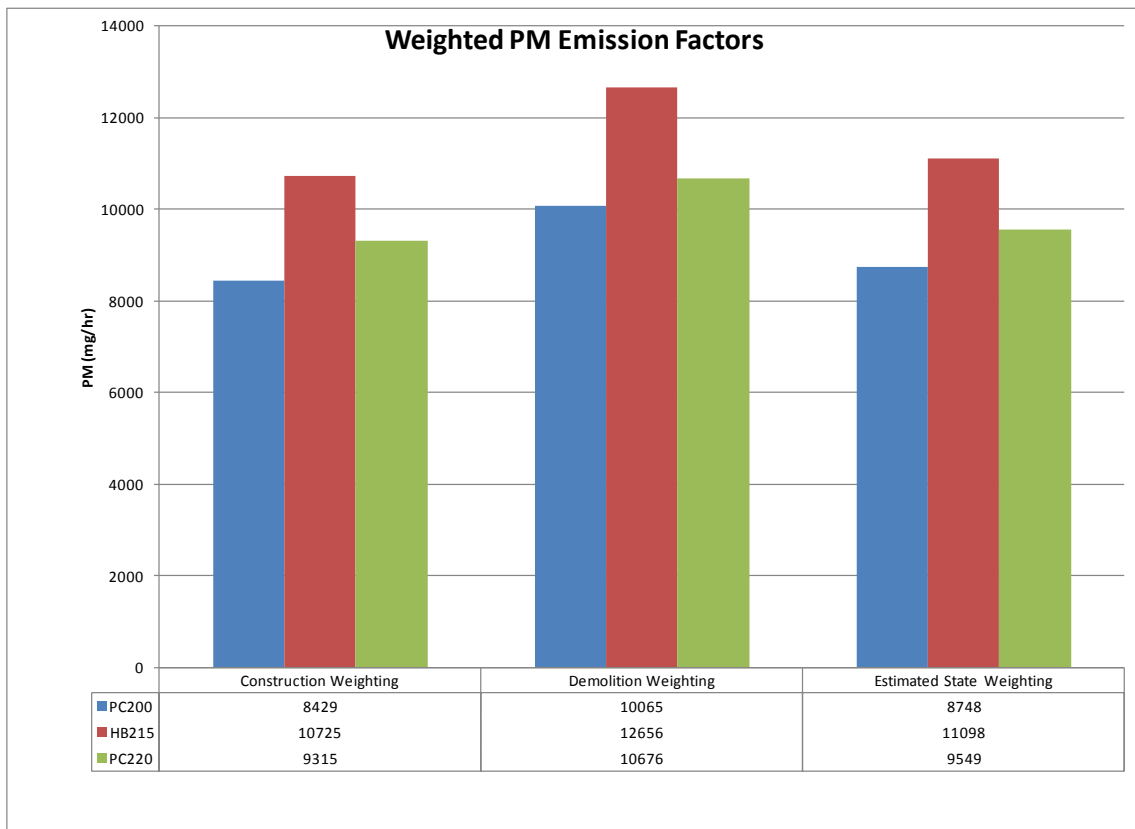
<sup>10</sup> According to interviews with Komatsu and the participants in the study, excavators in the size range of this study spend about 15% of their engine hours doing demolition types of work and the rest of the time they are in construction type of work.



**Figure 6-43 Model-average CO2 rate for construction, demolition, and statewide**



**Figure 6-44 Model-average NOx rate for construction, demolition, and statewide**



**Figure 6-45 Model-average PM rate for construction, demolition, and statewide**

As previously stated, Komatsu considers their PC200 to be the unit directly comparable to the HB215LC-1. By assuming that a “state average” mix of work would be done by the excavators, we can estimate a single number and that mainly the HB215LC-1 would take the place of the PC200 in the California market place, we can estimate a single number for benefits/dis-benefits of using the HB215LC-1 instead of the PC200. Table 6-12 summarizes the results of such assumptions. By purchasing the HB215LC-1 instead of the PC200 and using it as we have estimated the state-average usage for this size of excavator to be, the owner would realize a 16% fuel consumption benefit, but would emit about 27% more PM.

**Table 6-12 State-average benefits/dis-benefits of using the HB215 instead of the PC 200**

HB215LC-1 Weighted Comparison to the PC200				
CO <sub>2</sub>	NO <sub>x</sub>	PM	THC	CO
-16%	<b>1%</b>	<b>27%</b>	-70%	<b>8%</b>

1 Negative values mean hybrid benefit and positive values mean dis-benefit

2 Calculated using best estimate of the typical operating mode mix

## 7 Summary and Conclusions

The goal of the Hybrid Off-Road Equipment Pilot Project is to accelerate deployment of commercialized hybrid construction equipment while evaluating the emissions benefits of the equipment in real world applications. The main focus of this research is to evaluate the emissions impact of commercially-available hybrids construction equipment under real in-use operation relative to its non-hybrid counterparts. As part of this project, UC Riverside CE-CERT facilitated the deployment of 16 hybrid construction units with eight fleets operating in approximately eight locations. The hybrid construction equipment included ten Caterpillar D7E bulldozers and six Komatsu HB215LC-1 excavators. The determination of the hybrid benefit was divided into three main sub tasks, activity measurements, duty cycle development, and emissions testing. The summary conclusions for the deployment, activity measurements, duty cycle, and emissions results are presented in this section and cover all main points of this project.

### 7.1 Deployment

The program provided a total of \$901,578 voucher dollars towards the purchase of either hybrid and \$905,308 for the emissions and fuel economy testing of at least 6 bulldozers and 6 excavators, 3 hybrid and 3 conventional of each. The testing dollars include \$183,500 paid to the participants to offset disruptions in their normal operations while the testing was being conducted. Voucher dollars were used to reduce the purchase price of 16 hybrid pieces of construction equipment, ten Cat D7E bulldozers and six Komatsu HB215LC-1 excavators.

### 7.2 Activity measurements

The first phase of this program involved determining the activity, i. e. the types of physical work they perform and how much time is spent in each event, of the hybrid and conventional bulldozers and excavators. Activity measurement highlights include:

- CE-CERT assessed activity by using interviews, historical records, time-lapse video, ECM broadcast data, and real time GPS.
- Activity measurements were made on a subset of six hybrid and various comparable pieces of conventional equipment.
- Activity includes both physical work (P-work) and engine work (E-work).
  - P-work represents what is being pushed, lifted, dug, etc. and how.
  - E-work captures engine response to the load imposed by the physical work.
  - P-work dictates the load on the engine, engine speed, and how fast the unit moves.
  - Video data was critical for determining P-work.
- ECM data recorded during known activity from the video was critical in developing the duty cycles for emissions testing.
- ECM fuel flow data was evaluated and found to be relatively accurate. ECM fuel consumption data for the hybrid bulldozer compared within 5 percent to Waste Management's fuel records.

#### *Bulldozer*

- Over 160 hours of E-work and over 2000 hours of P-work data was collected for the bulldozers.
- For the bulldozer, P-work ranged from refuse pushing, road building, rock pushing, river bed clearing, to slope repairs
- For the bulldozer the video and GPS data were used to determine activity.
- Bulldozer activity consists of forward pushing and backward movement to prepare for next push.

- Statistical analysis of over 130,000 events was used as the basis of the proposed duty cycles for the bulldozers.

#### *Excavator*

- Over 160 hours of E-work and over 2000 hours of P-work was collected for the excavators.
- Excavator P-work varied significantly and represented over 15 different modes ranging from trenching, dressing (short rotations of excavator turn table to prepare a surface), lifting, holding, hammering, and demolishing. In each mode there were large and small buckets and long and short reaches, and short and long swings.
- For the excavator, activity was determined from video mode data rather than GPS monitoring, since excavator work consists of more stationary operations in which just the vehicle and/or swing arm rotates.
- Statistical analysis of the synchronized video mode data with ECM data reduced P-work work modes from 15 to seven work modes by combining work modes having similar ECM data. These seven work modes adequately characterized in-use excavator emissions.

### **7.3 Duty cycle development**

The activity logging effort led to the development of real world duty cycles, which are the cornerstone to determining the overall emissions benefit of off-road equipment hybridization. Representative and repeatable comparisons between hybrid and baseline equipment require having the equipment perform the same task under conditions as similar as physically possible. To relate in-use service conditions to controlled test conditions required a statistical analysis of the measured activity data. The duty cycles developed for the bulldozer and excavator are summarized below:

- Activity statistics show that the bulldozer push distance and power varies by operational mode and by fleet facility.
- Based upon the overall bulldozer statistical analysis, 10 meter, 30 meter, and 80 meter push distances at light and heavy loads were selected for the tests cycles. Repeatability was close to that of laboratory testing and showed low variability (i.e. less than 2% for engine load and around 5% for representative emissions).
- Based upon recorded excavator activity data, UCR developed a representative test cycle that drew heavily upon one previously proposed by Komatsu to evaluate the emissions and fuel economy of Komatsu hybrid and conventional excavators.
- Specific events evaluated over the representative cycle were: travel, idle, dress, trench with 45° swings, backfill, ditch with 90° swings, and dig with 180° swings. These modes represent both general construction and demolition type activity as recorded. Excavator swings are identified by the rotation of the upper structure with the base unit remaining in one position (i.e. not traveling).
- Two specific excavator vocations were identified, 1) general construction and 2) demolition. General construction includes shorter swings (trench 45 degrees) with some travel operation, and demolition includes dressing mode operation, longer rotations (180 degrees), and some travel.

### **7.4 Emissions of off-road hybrids**

The emissions and fuel consumption for the hybrid equipment were measured in-use during real world operation with AVL's federally compliant M.O.V.E portable emission measurement systems (PEMS). The AVL's M.O.V.E PEMS system includes measurements for carbon monoxide (CO), carbon dioxide (CO<sub>2</sub>), oxides of nitrogen (NO and NO<sub>2</sub>), total hydrocarbons (THC) and particulate matter (PM). Fuel consumption is measured using the carbon balance method similar to how vehicle

fuel economy measurements are made. The PEMS system was installed on each of the units tested while performing the duty cycles developed as part of this project. The emissions findings are summarized below:

- Emission measurements were successfully performed for both the hybrid and conventional bulldozer and excavator while performing the typical in-use duty cycles developed for this project.
- The emissions and fuel consumption performance evaluations were primarily based on the mass of emissions per ton of earth moved.
- Idle, travel, and non-earth moving activities were factored into the overall emissions comparison on a grams per hour basis with a weighting function derived in this project.
- Emissions on a per brake horse power hour, per fuel use, and per yard basis were also performed. Brake horse power was determined from ECM data and published lug curves for each engine.
- The final emissions and fuel consumption performance benefit for the hybrid D7E Tier 4 interim bulldozer are based on a comparison to the D6T Tier 4 interim conventional bulldozer.
- The final emissions and fuel consumption performance benefit for the hybrid HB215LC-1 Tier 3 excavator are based on a comparison to the PC200 Tier 3 conventional excavator.
- CO<sub>2</sub> emissions are directly related to fuel usage. Thus, a reduction in CO<sub>2</sub> emissions translates to a reduction in fuel consumption and improved fuel economy (FE).
- Hybrid emission and performance results are based on a comparison to the hybrid unit. Thus, negative numbers indicate a hybrid benefit (i.e. hybrid results are less than the conventional results) and positive number indicate a hybrid dis-benefit.

#### *Caterpillar conventional bulldozer selection*

- The D8T T4i and D8R Tier 2 are larger than the D7E making their overall comparison difficult and less robust compared with the D6T vs D7E analysis.
- The bsCO<sub>2</sub> between the D6T and D7E are similar (550 600 g/hp-h) for the heavy controlled pull, controlled in-use, and in-service tests thus making these units very comparable for a hybridization comparisons.
- The bsCO<sub>2</sub> between the D8T/D8R and the D7E were significantly different between the loaded controlled pull tests (680 to 700 g/hp-h) and in-service (550 to 600 g/hp-h), and in-revenue service tests (550 to 600 g/hp-h) thus making their comparison less robust.
- The D6T is the closest in size and engine horsepower to the D7E so, for evaluation of the benefit of hybridization, comparisons here will focus on comparison to the D6T.

#### *Caterpillar D7E vs D6T comparison*

- Two hybrid D7E bulldozers and one conventional D6T bulldozer were evaluated during both controlled pull and in-service testing at two different locations. As mentioned earlier, the D6T is the conventional bulldozer model most similar in power, size and other key parameters to the hybrid D7E.
- The CO<sub>2</sub> emissions benefit ranged from a 28% benefit to a 2% dis-benefit and depended on push distance and push effort.
- Fuel consumption is based on CO<sub>2</sub> emissions and thus its fuel savings also ranged from a 28% benefit to 2% dis-benefit and depended on push distance and push effort. In general, lighter, shorter pushes resulted in greater fuel economy benefit and heavier, longer pushes

resulted in less fuel economy benefit. Typically heavy pushes are found in large excavation, landfills, and rock quarry operations, and lighter pushes are found in slope repairs, maintenance, fine trim type work, and road repair work.

- The hybrid bulldozer had an overall NO<sub>x</sub> emission dis-benefit of 7% to 21%, depending upon work performed.
- No benefit or dis-benefit could be quantified for PM, CO, and THC due to the low emission levels from the aftertreatment system (ATS) equipped engines on both the D7E and D6T units.
- Overall average weighted emission and fuel consumption impacts identified are based on a best estimate of typical activity for similar large, California-based dozers, based upon fleet surveys, dealer information, and ARB's Diesel Off-Road On-Line Registration System (DOORS) data base (See main report for details).
- Weighted activity estimates resulted in the hybrid excavator having an overall CO<sub>2</sub> emissions and fuel consumption benefit of 14% and an overall NO<sub>x</sub> emissions dis-benefit of approximately 13%.
- Brake specific and fuel specific analysis confirmed the NO<sub>x</sub> dis-benefit for the in-service testing, in-use testing, and controlled pull tests for all modes.
- The engine lug curves showed that the engine speed range of the D7E is very narrow relative to the D6T and this may be causing the higher in-use NO<sub>x</sub> emissions.
- Measured NO<sub>x</sub> levels were below engine emission certification standards.

#### *Caterpillar D7E vs D8T and D8R comparisons*

- The D8T in-use testing and controlled pull testing showed the D8T engine did not operate with comparable brake specific fuel consumption compared to the D7E.
- The overall benefit of the D7E compared to the D8T-T4i and D8R-T2 was positive for both fuel consumption and NO<sub>x</sub>.
- Overall hybrid fuel consumption benefit is around 23% compared to both the D8T and D8R.
- A weighted average of 28% and 70% overall NO<sub>x</sub> emissions benefit, respectively, for the hybrid relative to the D8T and D8R conventional was observed.
- The hybrid had a benefit for PM, CO, and THC relative to the D8R, but this is due to the ATS system on the hybrid.
- Much of the NO<sub>x</sub> benefit is most likely due to differences in unit size and Tier differences and not the hybrid.
- Low speed operation of the hybrid showed higher THC emissions compared to the Tier 2 D8R thus suggesting ATS activation is poor for some light load operations.

#### *Komatsu conventional excavator selection*

- The hybrid excavator was similar in size to the PC200 and PC220. The PC200 has a slightly smaller capacity and engine power rating as compared to the PC220 but both have the same displacement.
- bsCO<sub>2</sub> emissions between the three units were all comparable and ranged from 550 to 600 g/hp-h for the conventionals and 480 to 550 g/hp-hr for the hybrid. The lower bsCO<sub>2</sub> for the hybrid is reasonable for a hybrid system where additional power was provided by the electric storage system. Thus, either the PC220 or PC200 are reasonable comparisons.
- While emission comparisons of the HB215LC-1 are similar to both the PC200 and PC220, Komatsu considers the HB215LC-1 to be a replacement of the PC200. For evaluation of the benefit of hybridization the focus will be on comparison to the PC200. Comparisons to the PC220 will be discussed in the body and appendices of this report.

### *Komatsu hybrid vs PC200 comparison*

- Two PC200 excavators and three HB215LC-1 hybrid excavators were evaluated using the representative test cycle developed for this project.
- The CO<sub>2</sub> benefit of the hybrid varied from a 28% benefit to a 1% dis-benefit, where the highest benefit was for dressing mode (i.e. light surface work with short rotations of the upper structure). The dis-benefit was for the travel mode.
- Demolition type work averaged about a 23% benefit (demolition work typically uses longer swings of the arm, which captures/releases more energy). General construction consists of more trenching and backfilling which resulted in a lower average of about a 13% benefit.
- The hybrid NO<sub>x</sub> emissions impact varied from an 18% benefit for demolition work to an 11% dis-benefit for general construction work.
- The hybrid PM dis-benefit was around 27% for all types of work and ranged from 6% for travel to 36% for backfill.
- The overall weighted emissions and fuel consumption estimates developed, based on activity data, fleet surveys, dealer information, and ARB's DOORS data base.
- Using the weighting estimates, the hybrid excavator had an overall fuel consumption, CO<sub>2</sub>, and THC emissions benefit of 16%, 16%, and 70% respectively and a NO<sub>x</sub>, PM and CO emissions dis-benefit of approximately 1%, 27%, and 8% respectively.

### *Komatsu hybrid vs PC220 comparison*

- Two PC220 excavators (slightly larger than the HB215LC-1 and the PC200) were also emissions tested since users felt it too might be replaced by the HB215LC-1 in certain types of work.
- The relative benefits when comparing the HB215LC-1 to the PC220 are larger than those measured for the PC200 and the relative dis-benefits are smaller.
- During heavy work the engine speed variation for the hybrid was much larger compared to the conventional PC200 and PC220 which may be the reason for the PM and CO dis-benefits
- If there were a comparison between a hybrid and conventional, both equipped with a DOC/DPF ATS, there probably wouldn't be a discernible benefit or dis-benefit for PM, THC, and CO.



## 8 Recommendations

The hybrid off-road pilot project was a success, but there are several areas where the investigators found there could be improvements. These include contract language for milestone distribution of funds during deployment, activity measurement analysis, utilizing existing databases, and duty cycles for emissions testing. Another big factor was lack of OEM manufacturer involvement. Thus this section provides recommendations or “lessons learned” to help improve future projects similar to this one. The following recommendations are broken down into each of the main sub groups, deployment, activity measurements, duty cycle development, and emissions testing.

### 8.1 Deployment

- Change contract milestones to pay out participants quicker. *Many people were concerned the state would not pay due to state budget challenges. As much as I tried to convince people the money was secure they were still reluctant. Quick paying would improve this relationship.*
- Most deployments seem to come from word of mouth not from any advertisements. *In future year's maybe advertisements will be needed if participation is lower.*

### 8.2 Activity characterization

- Operators and management interpretation of hybrid benefit differed. Consider some approach to consider both perspectives and understand why. *Operators are generally interested in getting work done, ease of use, and being comfortable. Managers are typically interested in maintenance, costs, and productivity.*
- Utilize ECM data for all video time if possible. *Additional ECM data may have provided new insights when different modes are identified by the video. Off-road equipment tends to do one job per week then move. This operation suggests additional time for acquiring data would be needed.*
- Collect more activity data for different types of work. *The data collected during this project is an important first step. But especially for the excavators, it is a fairly small data set in that only a few types of construction and demolition work were recorded. Therefore, it is possible that important work modes are not well represented or are not included at all. Future projects should attempt to broaden the types of work being recorded to fill some of the possible data gaps that remain after this project, such as truck loading operations that involve more swing.*

### 8.3 Duty cycle

- Pull test not may not be valuable to stakeholders, but was necessary to have apples to apples comparison to understand impact of hybrid and not performance details. Recommend adding additional tests to understand the performance benefit for stakeholders. *A good example would be to excavate dirt like at OC, but to setup the hybrid and base units as similar as possible. This would involve upgraded blades and similar undercarriages for both units. This would not be in the scope of work for this project, but with OEM support may have been possible and beneficial to the final outcome.*
- Determine a way to record swing angle during activity logging to a resolution of about 10 degrees or less. *For non-excavator units this may be some other unique operation typical for that unit. If further activity data collection is to occur, it would be helpful to record swing*

angle of the excavator's upper structure. The video data gave an indication of swing angle, but a more accurate, second-by-second record would add considerably to the certainty of what fraction of work involved swings of different amount. The resolution of such a measurement would need to be about 10 degrees or finer.

- Consider simplifying test by consolidating modes. It appears that a few of the test modes produce very similar emissions levels. Further analysis should be considered to determine if it would be possible to eliminate some of the test modes without losing significant emissions information. For example, if it turns out that the Dress and the Backfill modes produce essentially the same emissions results, one of them could be eliminated, simplifying the test, and the emissions weightings could be adjusted accordingly when calculating the final, weighted test result.
- Change to using trench dimension instead of time to determine when a test mode should end. A rough time-limit was used during the tests to determine when to end each mode. It would be more realistic to use distance measurements instead of time, since that is how trenches are specified in actual work. By marking a "start" and "end" location for each mode, the operator would be less tentative at the end of each mode and would not have to worry about watching another person to know when to stop.

#### 8.4 Emissions

- The hybrid bulldozer NO<sub>x</sub> dis-benefit (compared to D6T bulldozer) appears to be real where a slight change in ECM calibration could eliminate this affect. Based on the power vs engine speed analysis it appears the engine is operating in an area of higher NO<sub>x</sub>. If the engine manufacturer tuned the engine to lower NO<sub>x</sub> in the rpm range where the engine tends to operate during in-use operation they might obtain a NO<sub>x</sub> benefit instead of a dis-benefit.
- A comparison to the larger D8 units requires a test that is not apples to apples because the units' sizes are so different and so is their performance. Thus the best comparison is moving material. This requires a controlled setup with similar unit configuration for the desired application. OEM support will be necessary to make this reasonable otherwise costs will become significant for large equipment being tested.
- Changing the implementation of the hybrid excavator to stabilize the RPM variation during operation to reduce PM emissions and possibly NO<sub>x</sub> emissions. As discussed above, the PM dis-benefit for the excavators may be a result of the difference in RPM variations during operation. It is not clear if this would also reduce NO<sub>x</sub> emissions slightly. Presumably no PM benefit or dis-benefit would be observable if both units had an ATS.
- Possible ECM timing improvements to reduce the hybrid excavator NO<sub>x</sub> emissions to have a more consistent hybrid benefit for all modes. By changing the ECM fuel injection timing one can reduce NO<sub>x</sub> emissions. This may be part of the reason for the slightly higher NO<sub>x</sub> emissions due to the different operating location with-in the engine map. Slight ECM calibrations may be necessary to prevent a NO<sub>x</sub> dis-benefit.
- Consider hiring an expert consultant with the ability to supply mechanics, operators, and ample test area. Send all test units to them. This will improve emissions testing by using a coordinated test site and not an operational fleet. Possibly a general contractor who has access to a large consistent piece of land and professional operators. The general contractor should be selected for his interest in the outcome of the work and an owner of land to make quick decisions and to facility any needs in a timely manner. Testing efficiency and repeatability could be further improved by using "known entity" operators, a site that has already been well characterized as acceptable, and having support in the way of mechanics,

*fabricators, and equipment to help if something goes wrong during tests. We learned during this project that it is relatively simple to transport excavators from site-to-site, so using a single or two locations such as this would be more cost efficient for the project as well.*

- *Perform all testing at one location. Site to site differences were not significant and one could take advantage of working with one team to allow for a more productive and efficient testing program.*
- *Have each test unit pre-evaluated for proper maintenance and adjustment beyond just the engine and obvious systems. For example, one of the PC200 units had mal-adjusted tracks that apparently made it travel more slowly and significantly affected emissions. These unknowns could be reduced by having test units checked before being emissions tested by a mechanic and brought to proper operating specifications as required by the manufacturer. UCR's forms were updated to include specific items for each type of unit being tested.*

#### *Additional research*

- *Future hybrids and ATS equipped units should consider THC emissions during development to help maintain a low THC over the operation of the vehicle even for low power operation. Low speed operation of the hybrid showed higher THC emissions compared to the Tier 2 D8R thus suggesting ATS activation is poor for some light load operations.*
- *The results from this project are of high enough quality to be used for inventory purposes. Additionally the activity data could be analyzed for additional insights into operation modes and their significance and impact to emissions modeling.*

## References

1. Johnson, K. C., Burnette, A., Cao, T., Russell, R., AQIP Hybrid Off-Road Pilot Project: Activity Testing Final Test Plan, Part 1, Report to ARB April 2012
2. Seven, H. Development of a Worldwide harmonized Heavy-Duty Engine Emissions Test Cycle, Final Report TRANS/WP29/GRPE/2001/2, U.N. Economic Commission for Europe: Geneva Switzerland 2001
3. Gautam, M., Clark, N. N., Riddle, W., Wayne, W. S., Maldonado, H. Development and Initial Use of a Heavy-Duty Diesel Truck Test Schedule for Emissions Characterization, SAE Technical Paper 2002-01-1753, 2002
4. Zhen F., Clark N. N., Bedick R. C., Gautam M., Wayne, W. S., Thompson J. G., and Lyons W. D., Development of a Heavy Heavy-Duty Diesel Engine Schedule for Representative Measurement of Emissions, J. Air & Waste Manage. Assoc. DOI:10.3155/1047-3289.59.8.950, 2009
5. Couch, P., Leonard, J., Characterization of Drayage Truck Duty Cycle at the Port of Long Beach and Port of Los Angeles, Final Report to the Port of Long Beach Contract HD-7188, March 2011
6. Couch, P., Leonard, J., Development of a Drayage Truck Chassis Dynamometer Test Cycle, Final Report to the Port of Long Beach Contract HD-7188, August 2011
7. Shah S. D. "Development and Demonstration of a Methodology for Creating In-Use Emissions Test Cycles for Off-Road Heavy-Duty Diesel Vehicles, Masters Thesis, University of California, Riverside December 2002.
8. Presentation by Caterpillar, "US Army Tardec Dozer Production Study", Presented to Ventura County Naval Base, Port Hueneme, CA, November 2011
9. Johnson, K.C., Durbin, T.D., Jung, H., Cocker III, D.R., Giannelli, R., Bishnu, D., 2011. Quantifying In-Use PM Measurements for Heavy Duty Diesel Vehicles. In-Press Environ. Sci. Techol.
10. Johnson, K., C., Durbin, T., Khan, Y., M., Jung, H., Cocker, D., (2010). Validation Testing for the PM-PEMS Measurement Allowance Program. California Air Resources Board, November 2010, Contract No. 07-620, <http://eprints.cert.ucr.edu/505/>
11. Johnson, K., C., Durbin, T., D., Jung, H., Cocker, D., R., Khan, Y., M., (2011) Supplemental Testing of PPMD at CE-CERT to Resolve Issues with the PPMD Observed During the HDIUT PM MA Program, Final Report to Sensors Inc., May 2011
12. Johnson, K.C., Durbin, T.D., Cocker D.R., Miller, W.J., Bishnu, D.K., Maldonaldo, H., Moynahan, N., Ensfield, C., Laroo, C.A., (2009) On-road Comparisons of a Portable Emissions Measurement System with a Mobile Reference Laboratory for a Heavy-Duty diesel Vehicle, *Atm. Env.* 43 (2009) 2877-2833, 2009.
13. Johnson, K., C. (2010) PM Speciation and Analysis Evaluation on AVL's PM PEMS 494 Measurement System, Final Report to AVL North America, July 2010.
14. Johnson, K., AVL's MSS+GFM In-Use Comparison with UCR's MEL Over a Variety of Operating Conditions, Final Report to AVL North America July 2010

15. Durbin, T.D., Jung, H., Cocker, D.R., and Johnson, K. 2009. PM PEM's Pre-Measurement Allowance – On-Road Evaluation and Investigation. Final by UC Riverside to the Measurement Allowance Steering Committee, January.
16. Durbin, T.D., Jung, H., Cocker, D.R., Johnson, K., 2009. PM PEM's On-Road Investigation – With and Without DPF Equipped Engines. Final Report by UC Riverside to the Engine Manufacturers Association, July.
17. T.D. Durbin, K.C. Johnson, D.R. Cocker, J.W. Miller, "Evaluation and Comparison of Portable Emissions Measurement Systems and Federal Reference Methods for Emissions from a Back-up Generator and a Diesel Truck Operated on a Chassis Dynamometer," Environmental Science and Technology, 41, 17, 6199-6204, 2007.
18. Durbin, T., D., Miller, W., M., Welch, W., A., (2010) Evaluating Emissions from Heavy-Duty Front-End Loaders, Final Report to California Department of Transportation (CalTrans) Division of Research and Innovation, February 2010
19. Miller, J.W., Durbin, T.D., Johnson, K.J., Cocker, D.R., III, (2006) Evaluation of Portable Emissions Measurement Systems (PEMS) for Inventory Purposes and the Not-to-Exceed Heavy-Duty Diesel Engine Regulations; final Report for the California Air Resources Board, July.

## Appendix A. Activity Support Analysis Bulldozer

### Waste Management (WM) Analysis

#### *Waste Management D7E vs D8 and D9 evaluation summary*

According to the analysis done by WM, a full load of cover material is 22 tons. This compares well to a standard dump truck load of 15 to 25 tons. During previous WM tests, this load was spread in 2 pushes and 1 reverse by the D9 and in 3 pushes and 2 reverses by the D8 & D7E. This took from 1.6 minutes (D9) to 2.7 minutes (D7E). A full load from a residential packer of refuse is 12 tons. During the tests done by WM, this load was spread in 2 pushes and 1 reverse by both the D7E and the D8. This took 1.1 min. for the D7E and 1.5 min. for the D8. We conclude from this that the typical dense material piles a bulldozer would handle are 22 tons and take less than 3 minutes each to spread and the typical light material piles are 12 tons and take less than 2 minutes to spread.

### Waste Management (WM) Survey

After going through the D7E videos, there are 5 types of primary activity being observed. In anticipation of other types of activity for other D7E operations, have also included a 6<sup>th</sup> type of activity that was only observed a few times in the current activity data. We have called that mode “extended idling,” which may be found important for later cycle development in other industries that use the D7E.

1. **Pushing trash piles.** This was the most common activity for the D7E bulldozer at WM. Larry, a WM mechanic, suggests that the D6R onsite is retiring and the D7E will be doing more dirt work instead of pushing trash when that occurs. Luke, the maintenance supervisor, confirmed Larry’s statement thus suggesting the D7E will be doing additional dirt work in the future. The D7E will be the “jack of all trades” because its capability. According to Luke, the D7E can do what a D8 bulldozer normally does; at the same time doing smaller bulldozer (D6) work without being an overkill.
2. **Pushing dirt to cover trash.** During the length of this ECM logging period, cover trash with dirt seemed like the most common usage.
3. **Building roads.** Building roads for the D7E is very hard to tell from the cameras, the front camera will be facing up most of time which can be easily mixed up with another activity (compacting trash). I picked one for sure because I see the D7E pushing the gravel on the road.
4. **Walking the floor.** At WM, before building a new layer of trash, the previous layer needs to be sealed up so the piping below can be under a vacuum and trash decomposition gases do not leak to the atmosphere. When doing this activity, the bulldozer will going up and down, back and forth on the side of the trash layer that has been covered by dirt, compacting the dirt onto the trash and making sure the dirt smoothly and completely covers the trash layer. This is called “Walking the floor.”

5. **Building the ops layer.** Before starting a new layer, WM must ensure the plastic liner on the side wall of the pit is covered with dirt so no sharp trash can penetration the plastic liner. This protective layer of dirt is called the ops layer. I initially mixed up this activity with compacting trash layer and building roads, but after carefully going through the video I cannot find a clear segment of the bulldozer doing this activity.
6. **Extended idling.** Small amounts of idling occurs in many of the above modes. Typically these short idle periods last fewer than 60 seconds. WM has a strict idling policy, so we do not expect extended idling periods will be observed very often in WM activity data. However, records show idling can reach 15% according to WM

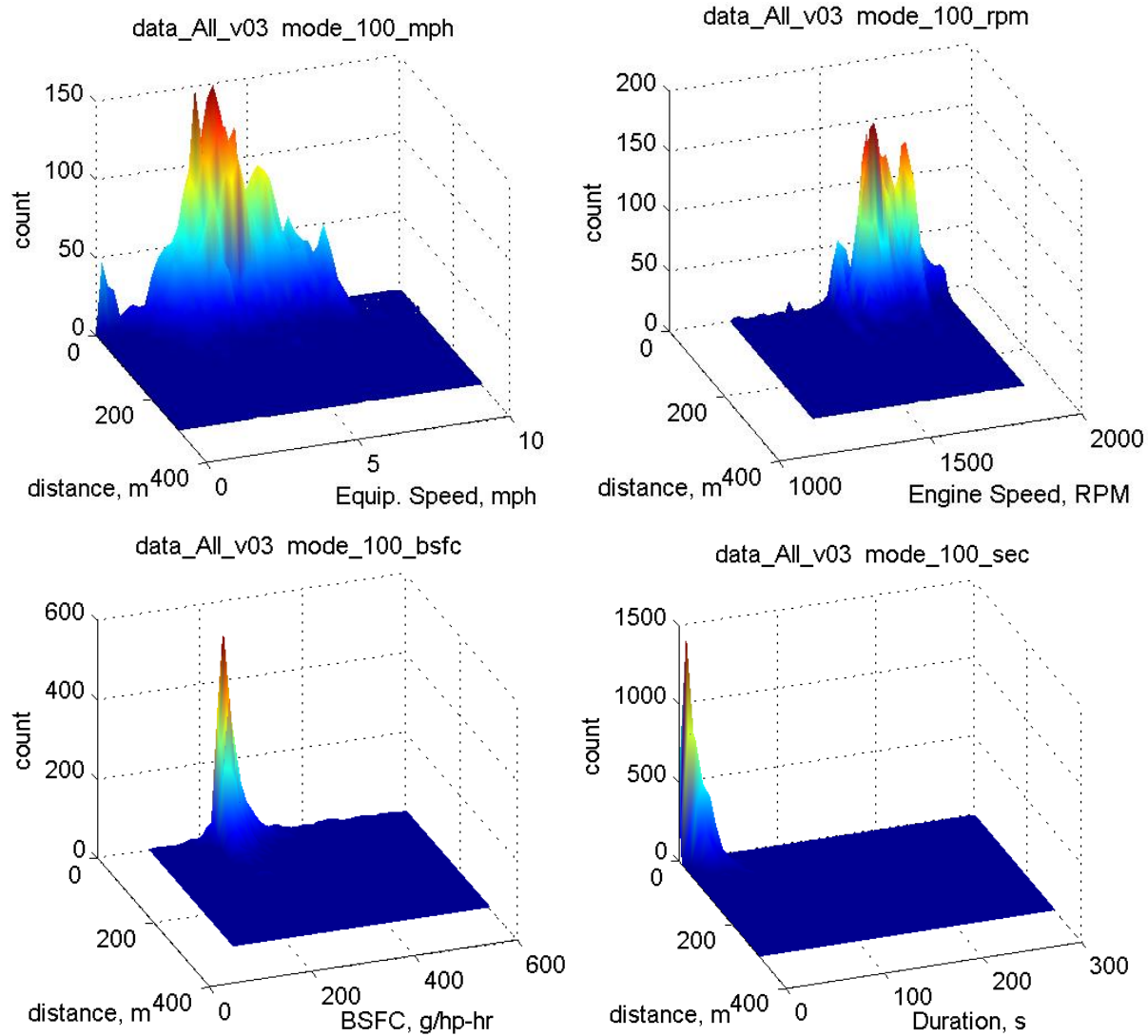


**Figure A1 WM video representation of the different operating modes.**

<sup>1</sup>The red lines indicates logged data over the course of 9 days, each time the bulldozer is switched on, the data is recorded. However, the video is always on.

<sup>2</sup>The green lines indicate the sections of ECM data used for analysis which will be shown below.



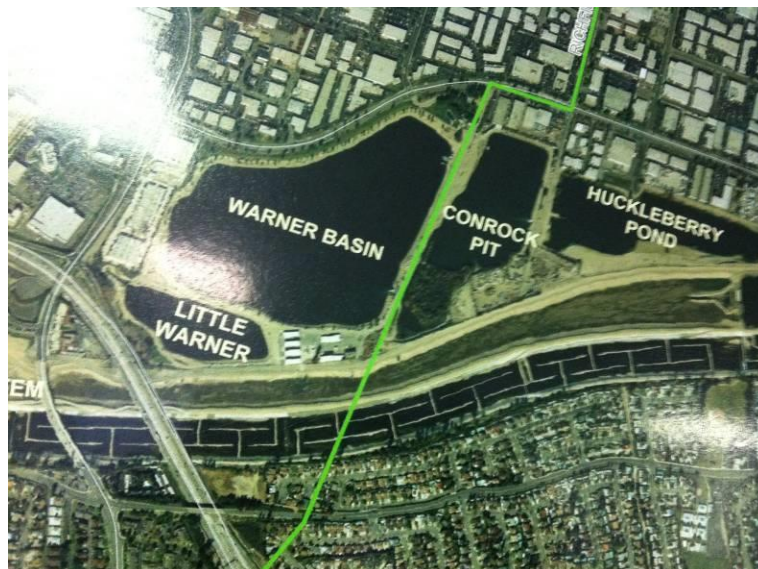


**Figure A2 WM fuel usage, engine speed, BSFC, and duration contour plots for the D7E**

### **Orange County Water District (OC) Survey**

UCR learned types of operations in OC during meeting on 7/17/12. The primary work goal at OC is to replenish the ground water supply from water flows at the Santa Ana River. This involves building longer flow path (building levees), building multiple off-river water basins, and maintaining river beds and basins all in effort for the ultimate goal, ground water since fresh water flow out to the ocean is considered as waste. After going through the D7E videos, there are 2 primary locations where all the bulldozer activity is being observed. The D7E is either doing work on the river bed or in the drained water basins. Thus, I divided activities into two main categories. In anticipation of other types of activity for other D7E operations, have also included a 3<sup>rd</sup> type of activity that was observed a lot more in the current activity data than at WM. We have called that mode “extended idling,” which may be found important for later cycle development in other industries that uses the D7E.

1. **River work:** one of the primary functions of bulldozers at OC is to maintain the Santa Ana River. In the fall, when there is more water flow. The bulldozer is used to build levees (see Figure 2) in the river to allow smooth flow thus more ground water penetration. The levees is either taken down or washed out during rainy seasons. Most of the time. The bulldozer is maintenance work such as flatten high spots in the wet riverbed and scrapping off dirt layers in the dried riverbed.
  - a. **Flattening high spot.** During this first round of data logging, only a brief period of this activity is observed. According Tom Stevens, the operations manager at OC. This type of work is often seen all year round. The bulldozer will simply hold the blade to a steady level, then push down the river bed. The engine loads is usually light and varies depending on river condition, the idea is to flatten the high spot and scrap off a light layer off the riverbed to allow more water penetration.
  - b. **Scrapping dirt/weed.** This is also considered as regular river maintenance as well. After speaking to the bulldozer operator, they change the river path every now and then depending on the amount of flow and season (see Figure 3). The purpose of this activity is to prep the hardened and dried up river bed surface for better water penetration. The process involves scrapping off the hardened dirt on the dried riverbed surface. Moreover, during this activity, the engine load is noticeably higher compare to in water push and the pattern more repeatable. At this point of time, I distinguish this activity by calling this one **dry river pushing** and flattening high spot **wet river pushing**.
  - c. **Building levees.** After review video recorded so far, there are no levee building observed in this round of recording. As seen in Figure 2, the series of “zigzagging” is man-made levees that allow more flow length then more time for water to penetrate. However, the levees work is only seasonal. During high water flow season, the levees have to be flattened so they do not cause any flood.

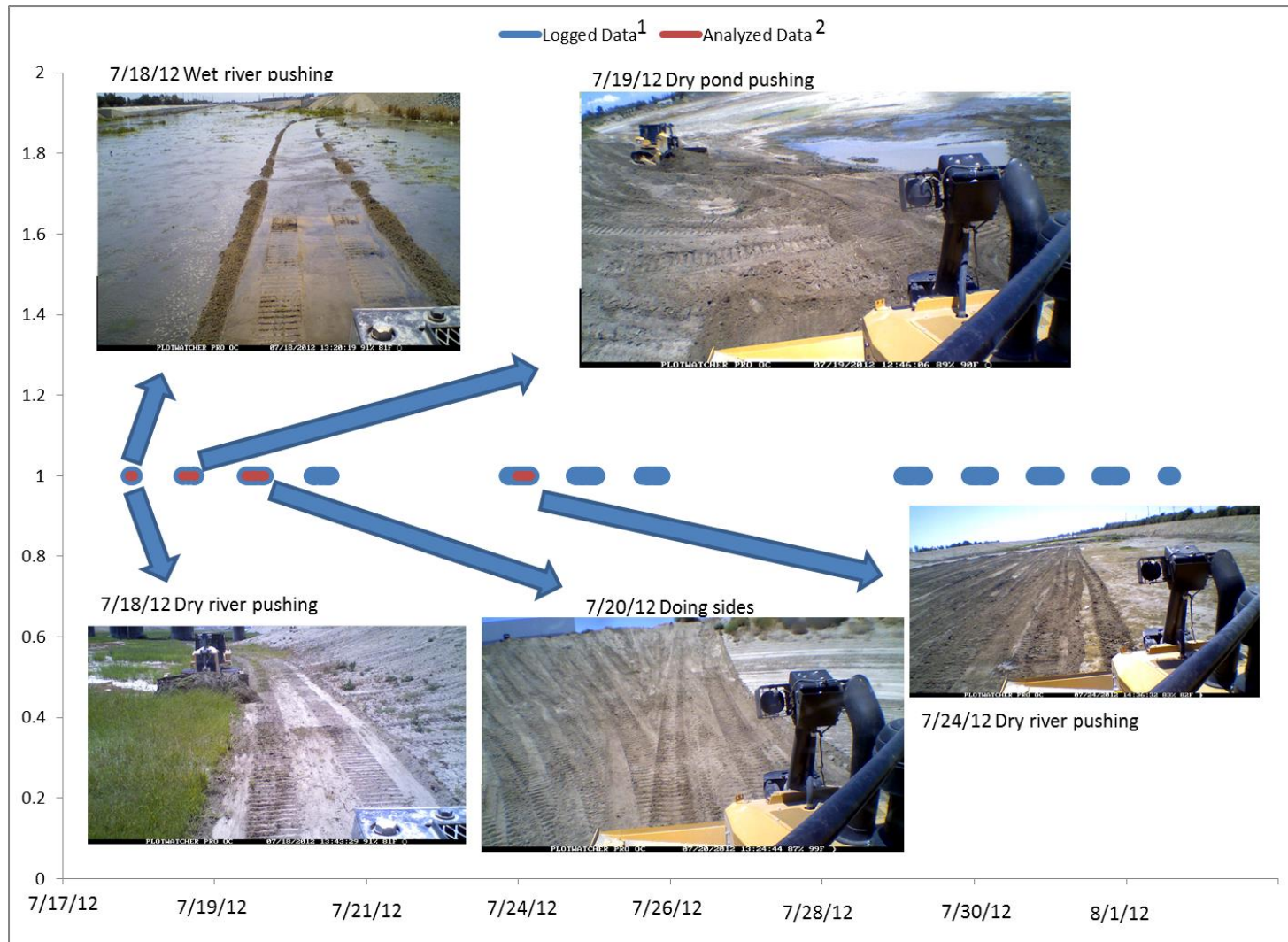


**Figure A3 Satellite image of Orange County Water District's river and off-river system.**



**Figure A4 Actual image of OC's river and off-river system.**

2. **Pond work.** Aside from building levees in the river, OC build series of man-made water basins along the Santa Ana River in contribution to the overall ground water penetration goal. Some of those basins are used for recreational purposes some are solely for water storage. Overtime, the basins will need to clean out completely as dead fishes and plants accumulate. The process involves draining the basin, clean out derbies off the bottom, flattens the bottom, and doing the sides. OC has many of these basins along the river and this is a year round operation according to the operations manager.
  - a. **Scrapping dirt/mud.** After a basin has been drained, the bulldozer is sent out to the bottom to clean/flatten out dirt and mud. The engine load varies a lot during this activity. Size of basin, amount of left over material, and operator's habit could all be a contributing factor on how bulldozer operates in this mode.
  - b. **Doing sides.** The sides of the basins will need to be redone; this activity is a lot like **walking the floor** in WM's analysis. The bulldozer will simply push dirt up on the sides of the basin then back down. The engine load trace is very repeatable in this case. Out of 2 days of pond work recorded, the bulldozers spent a day and a half doing sides at this basin.
3. **Extended idling.** A small amount of idling occurs in many of the above modes. Typically these short idle periods last fewer than 60 seconds. OC did not have records indicating the % of idling.



**Figure A5 Video activity of the different modes identified at OC operation.**

<sup>1</sup>The red lines indicates logged data over the course of 9 days, each time the bulldozer is switched on, the data is recorded. However, the video is always on.

<sup>2</sup>The green lines indicate the sections of ECM data used for analysis which will be shown below.

## County of Riverside Transportation Department (RC) Survey

UCR learned types of operations in RC through conversation with the operator as well from viewing record videos. The primary work goal for the D7E at RC is make road building material (“cold mix”) from country owned rock quarries. These involves cleaning weeds off the ground, making roads for trucks, and push the fine rock/dirt mixture up on a large pile. From that point the wheel loader take over, the loader loads the mixture from the large pile and load into a separator, the separator separates fine rock, from the dirt and large rocks. Then the fine rocks are trucked to the road building site. Figure 2 shows a good overview of the operations at RC. After going through the D7E videos, there are 2 primary locations where all the bulldozer activity is being observed. The activity study started at the Benton site near Temecula, California, about a week later the bulldozer is moved to the Juniper site near Homeland, California. The Juniper pit is a relatively newer pit than the Benton pit; there is a lot more site preparation compares to Benton site. In anticipation of other types of activity for other D7E operations, have also included a 3rd type of activity that was observed a lot more in the current activity data than at WM. We have called that mode “extended idling,” which may be found important for later cycle development in other industries that uses the D7E.

1. Site Preparation: from the initial review of video, the bulldozer spends a lot of time to clean up the rough terrain on the site. This involves making new road, weed cleaning, removing large rocks. The work pattern is rather random and hard to separate. Thus, all site preparation activity is grouped in to a same category for simplicity. Looking the ECM data supports the randomness of this activity; the engine load is usually light and hard to any trend.
2. Push up mixture pile. After site is been clean, the bulldozer spends some time gather material and then pushes the mix material up on a pile. The engine load is significantly more than site prep and more repeatable. The slope of the pile varies and there are several piles throughout the quarry. This activity includes gathering materials as well as steady pushes up on the pile.



**Figure A6 RC’s daily operation, the D7E is now on the top of the mixture pile.**



**Figure A7 Video activity of the different modes identified at RC operation.**

<sup>1</sup>The red lines indicates logged data over the course of 9 days, each time the bulldozer is switched on, the data is recorded. However, the video is always on.

<sup>2</sup>The green lines indicate the sections of ECM data used for analysis which will be shown below.

## Appendix B. Activity Data Filtering Bulldozer

The data filter includes raw data filtering and event filtering. Overall the raw data filter includes issues with GPS heading, excessive acceleration, and high BSFC at idle conditions and low power.

### *Heading development*

The activity data for the bulldozer shows that a bulldozer pushes and pulls in a single direction where GPS heading can be used to identify an event. Time was a function of how fast they moved and speed is dependent on the material and surface they are pushing on. Thus, most of the controlled variables are limited to media being pushed, surface pushing over and distance pushing. From this the operator is allowed to push at his normal feel to recreate the most “apples to apples” comparison

To recreate the a duty cycle out of the data collected it was determined to focus on defining an event as a move in one direction. This was the approach used by UCR to define a duty cycle for the comparison of the conventional and hybrid caterpillar bulldozer.

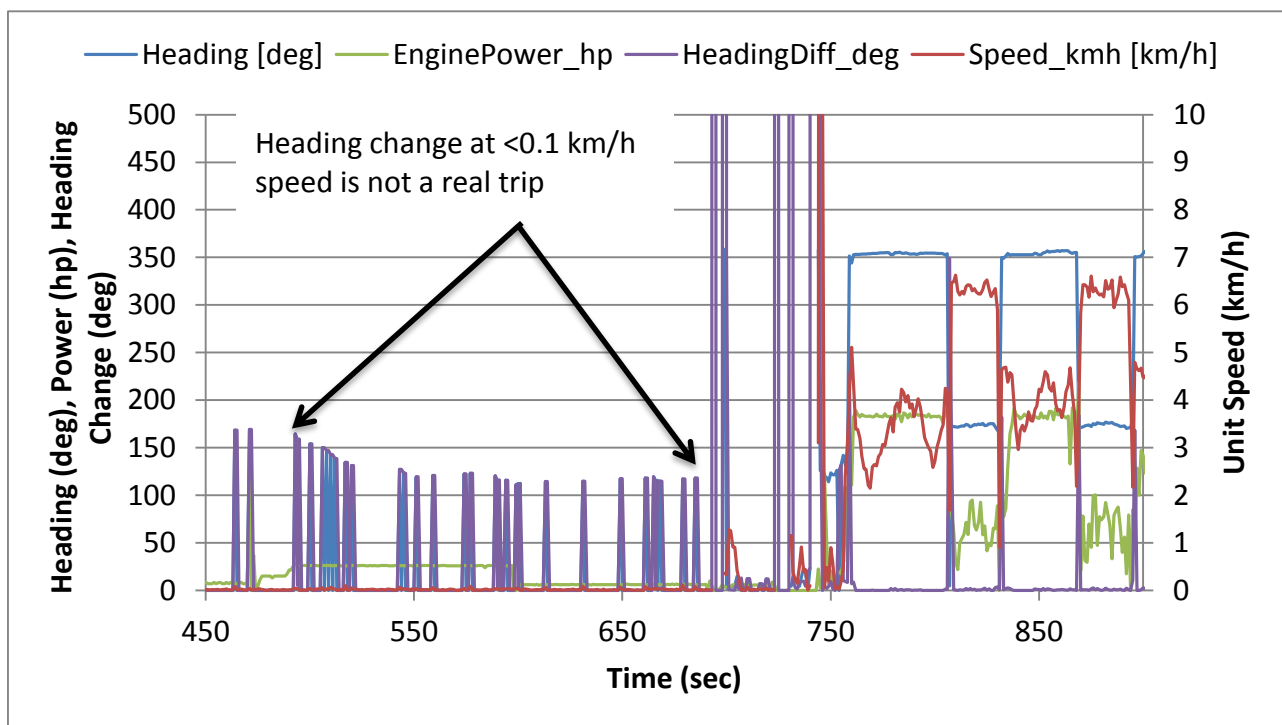


Figure B1 Incorrect heading identification due to no motion.

### *Filtering*

Several issues with the data analysis were discovered that affected the statistics of the micro events being evaluated. These issues are documented in this appendix to support the final results of the duty cycle. The issues include valid GPS satellite accuracy, high BSFC, heading change at 360 degrees, excessive acceleration, and heading change at low speeds. The list below shows the triggers used to reduce data:

Filters used on the data:

- 1.) Verify valid fix with at least 3 satellites for GPS heading accuracy
- 2.) Remove data with BSFC > 2000 (represents data without correct power and fuel usage)
- 3.) Heading changes must be greater than 100 and less than 300. Note heading changes between 350 and 10 is very small direction change. This was filtered out.
- 4.) Heading changes at unit speed < 0.1 km/h are not real. Set heading equal to previous value

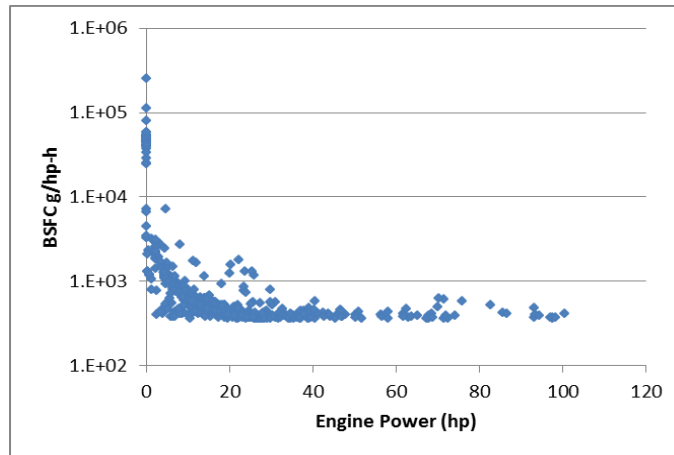
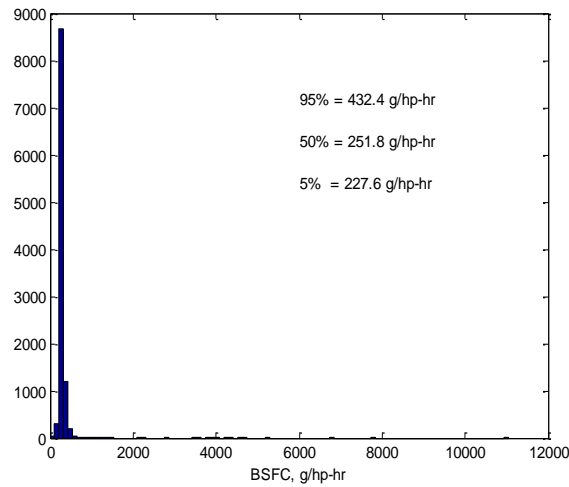


Figure B2 Engine speed (rpm) filtering for bsfc

Table B1 Mode percent of total activity for each participant



Data ID	mode	Events		% mode <sup>1</sup>
		gross	net	
WM_x	8399	8495	96	1%
WM_1	6386	8495	2107	25%
WM_2	4649	8495	3842	45%
WM_3	8263	8495	227	3%
WM_4	6404	8495	2081	24%
WM_5	8374	8495	121	1%
WM_D8_1	2039	2039	2039	100%
RC_x	1897	1901	4	0%
RC_6	1286	1901	610	32%
RC_7	619	1901	1282	67%
OC_x	1652	1652	5	0%
OC_8	673	1652	979	59%
OC_9	982	1652	670	41%
OC_10	1400	1652	252	15%

<sup>1</sup> Percent of events in this operating mode (mode ranges from 1 - 11).

### *Idle filtering*

Idle was filtered from the data to separate idle time and actual work time. Since off-road equipment has PTO operation idle is grouped as < 900 rpm, 900 < x < 1350, and >1350 rpm. These three idle modes represent the three dominant idle observations. An idle case is only considered by the following:

- 1) if there is 5 consecutive seconds of zero speed
- 2) zero speed is defined < 0.3 km/hr (due to GPS calculations and no ECM speed)
- 3) do not include rpm < 50 rpm (i.e. engine is off at 0).

Idle could not be defined by 0 km/hr due to no ECM speed and using GPS calculated speed. 0.3 km/hr was used since absolute speed was not available and zero speed is identified when the unit is below 0.25 km/hr. ECM velocity was not available on the tested units and thus GPS speed was used for all idle event identifications.

## Appendix E. PEMS Testing SOPs and Updates

### Abstract

Field testing requires a series of checks to be performed before, during, and after testing. These tests are critical for high quality data capture during research conducted at UC Riverside CE-CERT. Additionally these checks are important for understanding and assessing how the testing being performed is proceeding. This SOP process is critical and is a mandatory step in field testing at UCR. Please read and understand the following SOP's. This SOP is an on-going document based on lessons learned and is a tool used to train future PEMS engineers/students.

### Objectives

The objective of this SOP is to perform field emissions tests and to be confident at the end of the test that the PEMS, ECM, and test article were operated correctly and repeatable. Also it is expected that the measured data was collected and screened for basic consistency at the end of each test. The SOP's that follow are a working documents used to achieve the quality of data expected by UC Riverside CE-CERT.

### Revision History

06/04/2013 – Updated SOP by Sam, Eddie, and Kent to provide more detail on critical verifications prior to testing. Items added include ...

05/15/2013 – Updated SOP by Sam after completing AQIP project and training other staff people at CE-CERT prior to Trolley testing for AQMD. Added items such as....

11/04/2012 – Updated SOP for regenerations and testing repeat issues found during contrived testing

05/15/2012 – Updated SOP for actual installation details during Off-Road testing at WM

03/13/2012 – Created the SOP as part of the AVL audit and correlation effort

## Pre-Site Emissions Equipment Prep SOP 300-001

Date 04/17/2012

By Tanfeng Cao

The prep SOP is intended for performed checks a week (at least two days) prior testing, and allow sufficient time for necessary repairs. Checkup instruments in the following order:

### Checks and Maintenance

#### Gas Cylinders

1. Perform gas inventory check (ensure gas level is at least above 500 psi)
  - a. FID fuel (at least one or more backups)
  - b. Zero Gas: N<sub>2</sub> (at least one or more backups)
  - c. Span Gas: Quad blend (THC,NO,CO,CO<sub>2</sub>)
  - d. Span Gas: NO<sub>2</sub>

#### Gas PEMS

1. Check *heated filter*
2. Clean *heated sample line* with filtered shop air
3. Power on Gas PEMS
4. Turn on AVL system Control
5. Open Gas PEMS DUI in *Internet Explorer* (192.168.0.24)
6. Bring Gas PEMS to *pause* with FID fuel connected (large cylinder)
7. Do *leak check*
8. Bring Gas PEMS to *standby*
9. Go through all service pages and make sure there are NO warnings/errors
10. Do *zero, span, and audit*
11. Check date of last **linearity verification**, perform if necessary

#### AVL System Control

1. Start MOVE Application Desktop
2. Start SC 2.4, Load most recent parameter file
3. Verify GPS and ambient probe is fully functional

#### EFM

1. Clean tube and part with shop air if necessary
2. Power up box
3. Verify *TC1* and *TC2* are reading correct temperature
4. Verify communication to the AVL SC

## **PM PEMS**

1. Check and change filters if necessary
2. Check equipment for visual damage
3. Power up *MSS unit*, *Exhaust Conditioning Unit*, and *External Temperature Control*
4. Check *External Temperature Control Unit*, ensure TCs are working and temperature control works
5. Check the Sierra MFC in *Exhaust Condition Unit* using Sierra Software for functionality
6. Check window pollution level, perform service if necessary
7. Check and perform microphone linearity
8. Perform leak check
9. Put in Measurement mode, ensure sample path if clear.

## On-Site Emissions Equipment Prep SOP 300-002

Date 04/17/2012

By Tanfeng Cao

On-Site Emissions Equipment Prep is SOP to ensure emissions equipment is properly installed and working properly before leaving CE-CERT for the construction site.

### Gas PEMS Startup

1. Verify **Mastervolt Charger** is connected to wall power, the power button should be on
2. Verify **Emergency Stop** has no red light flashing, if so, reset by pull the *red nob* up then push *green button* down
3. Verify the front panel nob is turned to “*on*” position
4. Power on **Gas PEMS**, verify there is current flowing
  - a. NOTE: warm up of the PEMS will take at least 1 hour
  - b. The count down on the Gas PEMS DUI does not indicate it’s fully warm up
  - c. DO NOT warm up when it’s cold outside, if can’t power on PEMS, check fuse # 20 inside the **E-box**
5. Power up **M.O.V.E. system control**
6. Start “*M.O.V.E. Application Desktop*” from the desktop,
7. Enable AVL Gas PEMS Device User Interface (DUI) by open IE and type in 192.168.1.24
8. Switch to Analyzer View and switch on FID fuel; adjust pressure to approximately 3800 kpa (~50psi)
9. Wait until equipment is fully warmed up, send equipment to standby

### PEMS Pre-calibration checks

1. Select “*Service/Maintenance*”/”*Leak check*”, perform leak check
2. Ensure leakage is below **0.5%**, record number in log book
3. Below is optional:
4. Open Ak command, select the key button in lower left, select “*Service*” mode, enter “*mae493serv*” to enable service mode
5. Press “*Zero*” button on lower right, selection Zero adjust with “ambient air”
6. Perform “*Zero Adjust*” with N<sub>2</sub> if perform 1065 checks
7. Perform “*Audit*” with span gas to ensure all analyzer are working properly, the “*Span Adjust*” function is optional

### PEMS Calibration

1. Close down DUI window (open this in parallel will cause System Control software to crash)
2. Open M.O.V.E. system control V2.4 from desktop
3. Load the latest version of work environment files by open “*Start*”, load layouts

4. Adjust 493 Zero/Span settings first, save and load the setting after adjustment (you must stop data acquisition)
5. Select “*Device Control*”/ “*Update remote status*”, ensure all the valve are updating in the MOVE System tab, you might need to do this a few times, DO NOT proceed without all the valves being updated, restart computer/MOVE SC if necessary
6. Select “*Pretest*”, follow the pretest procedures (leak check, zero adjust, span adjust)
7. Select ‘*Device Control*’, zero the EFM by sending EFM to zero.
8. You may now start test any time, specify the length of the test, the last 150 seconds will be zero checks, do not set the test time too short or you will miss data during zero checks

### **Time Alignment**

1. DO NOT touch the clock on SC computer

### **EFM**

1. Power on EFM
2. Allow EFM to warm up completely

### **PM PEMS**

1. Power on **External Temperature Control**, watch until current drawn become stabilized, DO NOT proceed without fully warmed up
2. Power on **AVL PM PEMS (MSS & Exhaust Conditioning Unit)**
3. Turn on **AVL System Control**
4. Turn on laptop **MINIDIESEL**, ensure connect to wireless network “*diesel*”
5. Via **TightVNC Viewer** type in *192.168.0.100* to view **AVL System Control**
6. Start **AVL PM PEMS Device Control Software** program
  - a. Start “**AVL Startup**” program from windows status bar
  - b. Load AVL configuration from file
  - c. Put instrument in “**Remote**” mode from menu
  - d. Put instrument in “**User Level 2**” by entering password **-316**
  - e. Once available select “**Pause**” mode. This starts warming up the AVL
  - f. In “**service view numerical**” ensure “**sample line heating**” is checked
7. Wait until PEMS is fully warmed up and put PEMS in Standby
8. Put PEMS in Measurement mode, ensure “relative pressure” is > -10 mbar, if you have pressure such as -40 mbar, you have a pinch in sample line
9. Follow Dilution Flow Sheet to set Sierra MFC for dilution air flow.
10. Measure sample inlet with MFM, record this as “*sample flow*”
11. Measure sample inlet with MFM, pinch the dilution air flow, record this as “*total flow*”
12. Repeat above during end of day ensure dilution air don’t change

## On-Site Emissions Equipment Startup SOP 300-003

Date 04/17/2012

By Tanfeng Cao

On-Site Emissions Equipment Startup is SOP to ensure emissions equipment is properly installed and working properly before starting emissions test.

### On-Site Equipment Check List

1. Ensure PEMS rack is properly secured and no loose wires hanging
2. Ensure that are enough gas pressure on both cylinders
3. Check the EFM installation, ensure there is enough clearance around the flow tube
4. Ensure the ambient probe is installed securely and away from the exhaust
5. Restart SC computer before logging

### Gas PEMS

1. Select "HDIUT", specify desired sampling time, note the last 150 seconds will be zero check
2. Verify all data in "*Device Summary*" page look reasonable (ECM, EFM, Gas PEMS, Ambient, GPS)
3. Verify there is no flashing red warning lights
4. Verify nob on E-box front panel is turned on
5. Disconnect PEMS from wall power, now the battery should support at least 30 mins, switch to generator power as soon as possible
6. Start logging before leave the equipment, ensure data makes sense

### PM PEMS

1. Load filter, note down filter ID in notebook
2. Check for CFO pressures so the PM filter is properly loaded.
3. Start data logging, ensure the data makes sense before leaving the equipment

### ECM

1. If CAT ET or UniCAN will be used, ensure those tools are properly function before leaving the equipment
2. For CAT ET, select 8 hours for recording time, watch what channels are being recorded
3. For CAT ET, you will need restart each time the key is off
4. For UniCAN, ensure the ECM connection is secure, 12V power is working properly, and GPS is positioned near the window

## **Time Alignment**

1. Perform a rapid rpm event for EFM and emissions time alignment
2. Utilize PEMS post processor for posttest time alignment analysis



## On-Site Emissions Verifications SOP 300-004

Date 04/17/2012

By Tanfeng Cao

On-Site Emissions Equipment Verification is SOP to ensure emissions equipment is continuously working and nothing stopped working. This check list will be performed while testing is being performed.

### On-Site Check List

1. Verify ECM data are continuously updating
2. Verify Gas PEMS data are continuously updating
3. Verify EFM data are continuously updating
4. Verify ambient probe/GPS data are continuously updating
5. Verify PM PEMS data are continuously updating
6. Verify Sierra MFC is on the correct set point
7. Pay special attention for recorded time, good indicator if the test is froze or not
- 8. In event of MOVE software crash**
  - a. Close MOVE SC 2.4
  - b. Close MOVE Application desktop
  - c. Restart in the reverse order
  - d. Record new test with HDIUT, ignore the pre-test warning
  - e. Note down in notebook
- 9. In event of PM software crash**
  - a. Close DUI software
  - b. Restart DUI software
  - c. Restart data recording with different filename
  - d. Start Measurement mode
  - e. Start Filter Loading
  - f. Note down in notebook

### Before you ending test

1. Do not end AVL recording during zero mode
2. Select "*stop and save*" to save data file
3. Stop Filter Loading and put PM PEMS in sleep mode before shut down

## **On-Site Emissions Post Test Shutdown SOP 300-005**

Date 04/17/2012

By Tanfeng Cao

On-Site Emission Post Test Shutdown SOP is intended for proper shut down of the equipment.

### **On-Site Post Test Check List**

1. Perform posttest verification for Gas PEMS
2. Send Gas PEMS to pause
3. Ensure all AVL ifiles are properly saved
4. Send PM PEMS to pause, then to sleep
5. Set Sierra MFC (dilution air) to zero set point
6. Remove filter if necessary
7. Ensure all PM data files are properly saved
8. Check ECM logger if there is any, ensure files are properly saved
9. Power off EFM
10. Power off Gas PEMS
11. Shut off zero and FID fuel
12. Power off PM PEMS
13. Remove equipment

## **On-Site Emissions Post Test Evaluation SOP 300-006**

Date 04/17/2012

By Tanfeng Cao

On-Site Emissions Equipment Post Test is SOP to ensure emissions equipment operated for the test and some basic post processing was completed to show proper operation before continuing.

### **On-Site Data Evaluation Check List**

1. Post process AVL ifiles in AVL Concerto, do rough time alignment
2. Export Gas PEMS and flow data, input data into "Data Evaluation Worksheet"
3. Import PM PEMS data in to the same worksheet
4. Import ECM data into the work sheet if possible
5. Check Summary tab for NO<sub>x</sub>, PM, and ECM plot
6. Check Carbon Balance plot in the same tab
7. Ensure data looks reasonable based on engineering judgment, if not reasonable, retest might be necessary

## **On-Site ECM Checklist SOP 225-002**

Date 4/17/2012

By Robert L. Russell

On-Site ECM Checklist is SOP to ensure ECM equipment is properly installed and recording ECM and GPS data.

### **On-Site Checklist**

1. Verify that the ECM equipment is being installed on the correct construction equipment.
2. Verify that the ECM equipment is securely installed.
3. Connect the wires from the ECM to the construction equipment power source.
4. Verify that the ECM equipment and wires will not interfere with construction equipment operation or operator.
5. Have construction equipment operator start the construction equipment.
6. Turn ECM on and synchronize date and time with video date and time
7. Verify there is space for a weeks worth of ECM data storage.
8. Verify that the ECM is logging data.
9. Verify that GPS data is updating and logging.
10. Take photo of ECM and construction equipment.

## **Post-Site ECM Checklist SOP 225-003**

Date 4/17/2012

By Robert L. Russell

Post-Site ECM Checklist is SOP to ensure ECM and GPS data is downloaded for analysis at CE-CERT.

### **Post-Site Checklist**

1. Verify that the ECM equipment is still securely mounted and in same location.
2. Verify that the ECM equipment is securely installed.
3. Have construction equipment operator start the construction equipment.
4. Download the ECM and GPS Data.
5. Verify that the ECM is logging data.
6. Verify that GPS data is updating and logging.
7. Return to CE-CERT to review data.
8. Verify that video, ECM, and GPS data cover same time period.
9. Check ECM for reasonable rpm transients.
10. Check GPS for changes in latitude and longitude.
11. Review video paying particular attention to times of ECM rpm transients.
12. Write down video based activity during ECM rpm transients.

## **Pre-Site Equipment Inspection Checklist SOP 275-001**

Date 10/04/2012

By Tanfeng Cao

Pre-Site equipment inspection checklist is SOP to ensure all the necessary tools is prepared for on-site equipment inspection.

### **Pre-Site Checklist**

1. Verify that the ECM tools are working, practice on our own engine dyno if necessary
  - a. CAT ET
  - b. Kavaser
  - c. Cummins In-site
  - d. Dearborn Adapter
  - e. AVL MOVE System control
  - f. UniCAN
2. Gather all necessary wires and connections
3. Computers for using the ECM tools
4. Bring PEMS tool bag for installation measurements
5. Bring camera out of MEL for taking pictures
6. Arrange time and location ahead for equipment inspection
7. Reserve vehicles for travel

## **On-Site Equipment Inspection Checklist SOP 275-002**

Date 10/04/2012

By Tanfeng Cao

On-Site equipment inspection checklist is SOP to ensure all necessary information is obtain before leaving the equipment

### **On-Site Checklist**

1. Take photos of exterior of equipment
2. Take photos of engine compartment of the equipment
3. Inspect for any damage
4. Ask for last service date, and if the equipment is due for a service or not
5. Ask for the overall condition of the equipment
6. Ask if the engine ever had a major overhaul
7. Find platform for PEMS installation
8. Take measurement of the platform and check for steadiness
9. Ask the operator to see if it's ok to put a 300 lb object on the selected platform
10. Ensure there are plenty of secure points
11. Make exhaust measurements
12. For strange exhaust setups, check to see if the exhaust can be removed
13. Find ECM connector location inside the cab
14. Try manufacturers' ECM diagnostics tools first
15. Take screen shots of the results, do product status report if possible
16. Try Kavaser tool, see if there is any message come through
17. Use J1939 interrupter, take screen shots of set up, and copy data out the excel
18. If the output appear to be proprietary, try sending CAN requests, record the ECM response
19. If UniCAN datalogger is available, connect in parallel with the Kavaser tool, record the CAN bus traffic
20. Remove equipment
21. Ask operator for his/her regular schedule
22. Ask for general location of the equipment
23. Ask for install support if possible

## **Post-Site Equipment Inspection Checklist SOP 275-003**

Date 10/04/2012

By Tanfeng Cao

Post-Site equipment inspection checklist is SOP to document the results of the on-site inspection.

### **Pre-Site Checklist**

1. Unload photos from camera
2. Unload ECM information
3. Combine information in same folder and save on server
4. Compose summary of the visit
5. Ensure there are necessary exhaust part
6. Ensure the current ECM tools on hand will work on the equipment



## Appendix F. Equipment and Earth Bulk Materials

WEIGHT* OF MATERIALS	LOOSE		BANK		LOAD FACTORS
	kg/m <sup>3</sup>	lb/yd <sup>3</sup>	kg/m <sup>3</sup>	lb/yd <sup>3</sup>	
Basalt .....	1960	3300	2970	5000	.67
Bauxite, Kaolin .....	1420	2400	1900	3200	.75
Caliche .....	1250	2100	2260	3800	.55
Carnotite, uranium ore .....	1630	2750	2200	3700	.74
Cinders .....	560	950	860	1450	.66
Clay — Natural bed .....	1660	2800	2020	3400	.82
Dry .....	1480	2500	1840	3100	.81
Wet .....	1660	2800	2080	3500	.80
Clay & gravel — Dry .....	1420	2400	1660	2800	.85
Wet .....	1540	2600	1840	3100	.85
Coal — Anthracite, Raw .....	1190	2000	1600	2700	.74
Washed .....	1100	1850			.74
Ash, Bituminous Coal .....	530-650	900-1100	590-890	1000-1500	.93
Bituminous, Raw .....	950	1600	1280	2150	.74
Washed .....	830	1400			.74
Decomposed rock —					
75% Rock, 25% Earth .....	1960	3300	2790	4700	.70
50% Rock, 50% Earth .....	1720	2900	2280	3850	.75
25% Rock, 75% Earth .....	1570	2650	1960	3300	.80
Earth — Dry packed .....	1510	2550	1900	3200	.80
Wet excavated .....	1600	2700	2020	3400	.79
Loam .....	1250	2100	1540	2600	.81
Granite — Broken .....	1660	2800	2730	4600	.61
Gravel — Pitrun .....	1930	3250	2170	3650	.89
Dry .....	1510	2550	1690	2850	.89
Dry 6-50 mm (1/4"-2") .....	1690	2850	1900	3200	.89
Wet 6-50 mm (1/4"-2") .....	2020	3400	2260	3800	.89
Gypsum — Broken .....	1810	3050	3170	5350	.57
Crushed .....	1600	2700	2790	4700	.57
Hematite, iron ore, high grade .....	1810-2450	4000-5400	2130-2900	4700-6400	.85
Limestone — Broken .....	1540	2600	2610	4400	.59
Crushed .....	1540	2600	—	—	—
Magnetite, iron ore .....	2790	4700	3260	5500	.85
Pyrite, iron ore .....	2580	4350	3030	5100	.85
Sand — Dry, loose .....	1420	2400	1600	2700	.89
Damp .....	1690	2850	1900	3200	.89
Wet .....	1840	3100	2080	3500	.89
Sand & clay — Loose .....	1600	2700	2020	3400	.79
Compacted .....	2400	4050			
Sand & gravel — Dry .....	1720	2900	1930	3250	.89
Wet .....	2020	3400	2230	3750	.91
Sandstone .....	1510	2550	2520	4250	.60
Shale .....	1250	2100	1660	2800	.75
Slag — Broken .....	1750	2950	2940	4950	.60
Snow — Dry .....	130	220			
Wet .....	520	860			
Stone — Crushed .....	1600	2700	2670	4500	.60
Taconite .....	1630-1900	3600-4200	2360-2700	5200-6100	.58
Top Soil .....	950	1600	1370	2300	.70
Taprock — Broken .....	1750	2950	2610	4400	.67
Wood Chips** .....	—	—	—	—	—

\*Varies with moisture content, grain size, degree of compaction, etc. Tests must be made to determine exact material characteristics.

\*\*Weights of commercially important wood species can be found in the last pages of the Logging & Forest Products section. To obtain wood weights use the following equations: lb/yd<sup>3</sup> = (lb/ft<sup>3</sup>) × .4 × 27  
kg/m<sup>3</sup> = (kg/m<sup>3</sup>) × .4

## Appendix G. Caterpillar Bulldozer Specifics

From: Caterpillar Performance Handbook, Edition 29

The following is an example of a scraper load time study form. Numbers in the white columns are stop watch readings; numbers in the shaded columns are calculated:

Total Cycle Times (less delays)	Arrive Cut	Wait Time	Begin Load	Load Time	End Load	Begin Delay	Delay Time	End Delay
	0.00	0.30	0.30	0.60	0.90			
3.50	3.50	0.30	3.80	0.65	4.45			
4.00	7.50	0.35	7.85	0.70	8.55	9.95	1.00	10.95
4.00	12.50	0.42	12.92	0.68	13.60			

**NOTE:** All numbers are in minutes

This may be easily extended to include other segments of the cycle such as haul time, dump time, etc. Similar forms can be made for pushers, loaders, bulldozers, etc. Wait Time is the time a unit must wait for another unit so that the two can function together (haul unit waiting for pusher). Delay Time is any time, other than wait time, when a machine is not performing in the work cycle (scraper waiting to cross railroad track).

### Waste Disposal

- Rule of Thumb for amount of Cover Material:
  - o Typically about 1 cu m of cover material per 4 cu m of waste. Can be higher for smaller landfills.
- Choosing equipment based upon distance to be moved:
  - o Track-type tractor 0-90 m (0-300 ft)
  - o Track loader 0-152 m (0-500 ft)
  - o Wheel loader 0-185 m (0-600 ft)
  - o Wheel tractor-scraper over 185 m (over 600 ft)
- Weather conditions (wet or frozen cover) can require use of tracks instead of wheels for better traction
- Refuse Densities:
 

o Type:	kg/m <sup>3</sup>	lb/yd <sup>3</sup>
o Loose Refuse:	148-178	250-300
o Packer Truck	237-415	400-700
o Fill Density:	356-890	600-1500
o Refuse and Cover:	415-1009	700-1700
- To obtain maximum density, waste should be spread and compacted in layers not exceeding a depth of 610 mm (2 ft).

## **Appendix H. Equipment Inspection Report**

The equipment inspection form is a duplicate of our on-highway form. This form will be used for vehicle check-in. For checks that are not reasonable such as tires on a tracked unit that section will be left blank. Due to the nature of off-road equipment no one vehicle check can cover all basis. As such, UCR feels this check will provide a consistent inspection form for off-road equipment. Additional items will be check as needed during the testing campaign on an as-needed basis.

# Equipment Inspection Form

Unit. No.: \_\_\_\_\_

VIN: \_\_\_\_\_

ARRIVAL	ARRIVAL
AGENCY RELEASE	
DELIVERED BY:	

DEPARTURE	DEPARTURE
UCR ENGINEER	
RETURNED TO:	

Retest?  Yes  No. If Yes, reason for retest: \_\_\_\_\_

## Engine Compartment

REMARKS

OIL LEVEL:	<input type="checkbox"/> FULL <input type="checkbox"/> LOW	
COOLANT LEVEL:	<input type="checkbox"/> FULL <input type="checkbox"/> LOW	
POWER STEERING FLUID:	<input type="checkbox"/> FULL <input type="checkbox"/> LOW	
CONDITION OF BELTS:	<input type="checkbox"/> GOOD <input type="checkbox"/> WORN	
CONDITION OF AIR FILTER:	<input type="checkbox"/> CLEAN <input type="checkbox"/> DIRTY	
VISIBLE EXHAUST LEAKS:	<input type="checkbox"/> YES <input type="checkbox"/> NO	
VISIBLE FLUID LEAKS:	<input type="checkbox"/> YES <input type="checkbox"/> NO	
ENGINE APPEARANCE:	<input type="checkbox"/> CLEAN <input type="checkbox"/> GREASY	

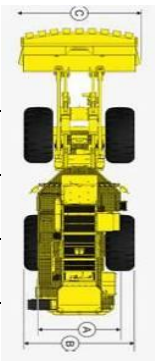
## Equipment

SERVICE BRAKES:	<input type="checkbox"/> GOOD <input type="checkbox"/> POOR <input type="checkbox"/> TOUCHY
PARKING BRAKES:	<input type="checkbox"/> GOOD <input type="checkbox"/> POOR
POWER DIVIDER:	<input type="checkbox"/> GOOD <input type="checkbox"/> DEFECTIVE <input type="checkbox"/> NOT EQUIPPED
TRANSMISSION:	<input type="checkbox"/> NORMAL <input type="checkbox"/> SHIFTS HARD <input type="checkbox"/> NOISY
LUG NUT COVERS:	<input type="checkbox"/> YES <input type="checkbox"/> NO NUMBER MISSING:
TIRE CONDITION:	FRONT <input type="checkbox"/> GOOD <input type="checkbox"/> WORN REAR <input type="checkbox"/> GOOD <input type="checkbox"/> WORN
REMARKS:	

## Vehicle Interior

UPHOLSTERY:	<input type="checkbox"/> CLEAN <input type="checkbox"/> DIRTY <input type="checkbox"/> STAINED <input type="checkbox"/> DAMAGED	REMARKS:
CARPET:	<input type="checkbox"/> CLEAN <input type="checkbox"/> DIRTY <input type="checkbox"/> STAINED <input type="checkbox"/> DAMAGED	REMARKS:
GENERAL APPEARANCE:	<input type="checkbox"/> CLEAN <input type="checkbox"/> DIRTY	REMARKS:
GAUGES AND CONTROLS:	<input type="checkbox"/> OPERATE PROPERLY <input type="checkbox"/> DEFECTIVE	REMARKS:

**Vehicle Exterior** (mark the location and describe any dents, scratches, damaged lights, mirrors etc. when the vehicle was received by UCR):

1. _____		10. _____
2. _____		11. _____
3. _____		12. _____
4. _____		13. _____
5. _____		14. _____

6.	15.
7.	16.
8.	17.
9.	18.

Was this vehicle damaged while in UCR custody? Yes No. If Yes, explain: \_\_\_\_\_

\_\_\_\_\_  
\_\_\_\_\_

**General Remarks**

\_\_\_\_\_  
\_\_\_\_\_  
\_\_\_\_\_  
\_\_\_\_\_

## Attachment E: Equipment Information Form

Agency: \_\_\_\_\_  
 Address: \_\_\_\_\_  
 Contact Person: \_\_\_\_\_  
 Phone Number/Email: \_\_\_\_\_  
 Vehicle Manufacturer/ChassisType: \_\_\_\_\_  
 Vehicle Occupancy Capacity: Seated \_\_\_\_\_ Standing \_\_\_\_\_  
 Agency Vehicle #: \_\_\_\_\_ License Plate #: \_\_\_\_\_  
 Vehicle Model Year: \_\_\_\_\_ VIN #:(17 DIGIT) \_\_\_\_\_  
 GVWR Front: \_\_\_\_\_ Middle: \_\_\_\_\_ Rear: \_\_\_\_\_  
 Curb Weight: Front: \_\_\_\_\_ Middle: \_\_\_\_\_ Rear: \_\_\_\_\_  
 Vehicle Dimensions: Length: \_\_\_\_\_ Width: \_\_\_\_\_ Height: \_\_\_\_\_  
 Mileage Odometer: \_\_\_\_\_ Hub Meter: \_\_\_\_\_  
 Engine Manufacturer: \_\_\_\_\_ Model: \_\_\_\_\_ Year: \_\_\_\_\_  
 Engine Serial#: \_\_\_\_\_ EPA Family Cert. #: \_\_\_\_\_  
 Engine Displacement: \_\_\_\_\_ # of Cylinders: \_\_\_\_\_ Configuration: \_\_\_\_\_  
 Max. Engine Power (hp) \_\_\_\_\_ hp @ \_\_\_\_\_ RPM  
 Max. Engine Torque:(ft-lb.) \_\_\_\_\_ ft-lbs @ \_\_\_\_\_ RPM  
 Idle Speed: \_\_\_\_\_ Governed Speed: \_\_\_\_\_ High Idle: \_\_\_\_\_  
 Electronic Engine Control (Y/N) If Yes, Rebuild: \_\_\_\_\_  
 Engine Rebuilt (Y/N) If Yes, Year of Rebuild: \_\_\_\_\_  
 Primary Fuel Type: D1 D2 CNG LNG BD (%) Other (Specify): \_\_\_\_\_  
 Number of Fuel Tanks: \_\_\_\_\_ Capacity: \_\_\_\_\_  
 Oil Type: Weight \_\_\_\_\_ Brand \_\_\_\_\_  
 Aftertreatment Configuration:  
 Oxidation Catalyst (Y/N) Manufacturer \_\_\_\_\_  
 PM Trap (Y/N) Manufacturer \_\_\_\_\_  
 SCR (Y/N) Manufacturer \_\_\_\_\_  
 NOx Absorber (Y/N) Manufacturer \_\_\_\_\_  
 NH3 Catalyst (Y/N) Manufacturer \_\_\_\_\_  
 Other (Y/N) Manufacturer \_\_\_\_\_  
 Total Number of Axles: \_\_\_\_\_ Number of Drive Axles: \_\_\_\_\_  
 Transmission Type: Auto/Manual \_\_\_\_\_ Speeds: \_\_\_\_\_  
 Transmission Manufacturer \_\_\_\_\_  
 Hybrid Technology (Y/N) Comment: \_\_\_\_\_  
 Tire Size: \_\_\_\_\_ Tire Manufacturer: \_\_\_\_\_ Type(Bias Radial Other)

Tailpipe Size: \_\_\_\_\_ Location/Configuration: \_\_\_\_\_

## Appendix I. Supplementary Emissions Bulldozer

Additional bulldozer emissions testing results will be presented in this section including detailed emissions comparison results in g/hr, in g/kgfuel, and in g/hp-hr.

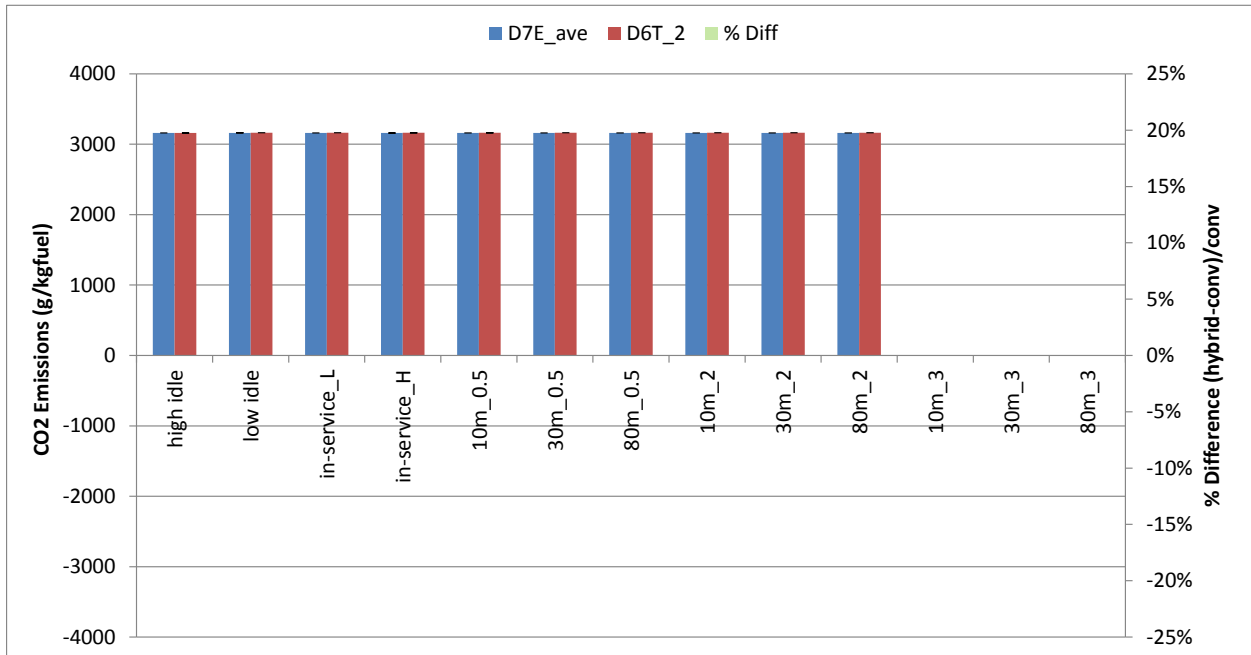
### 1 D7E-T4i vs D6T-T4i Supplementary Results

#### 1.1 Controlled pull test results

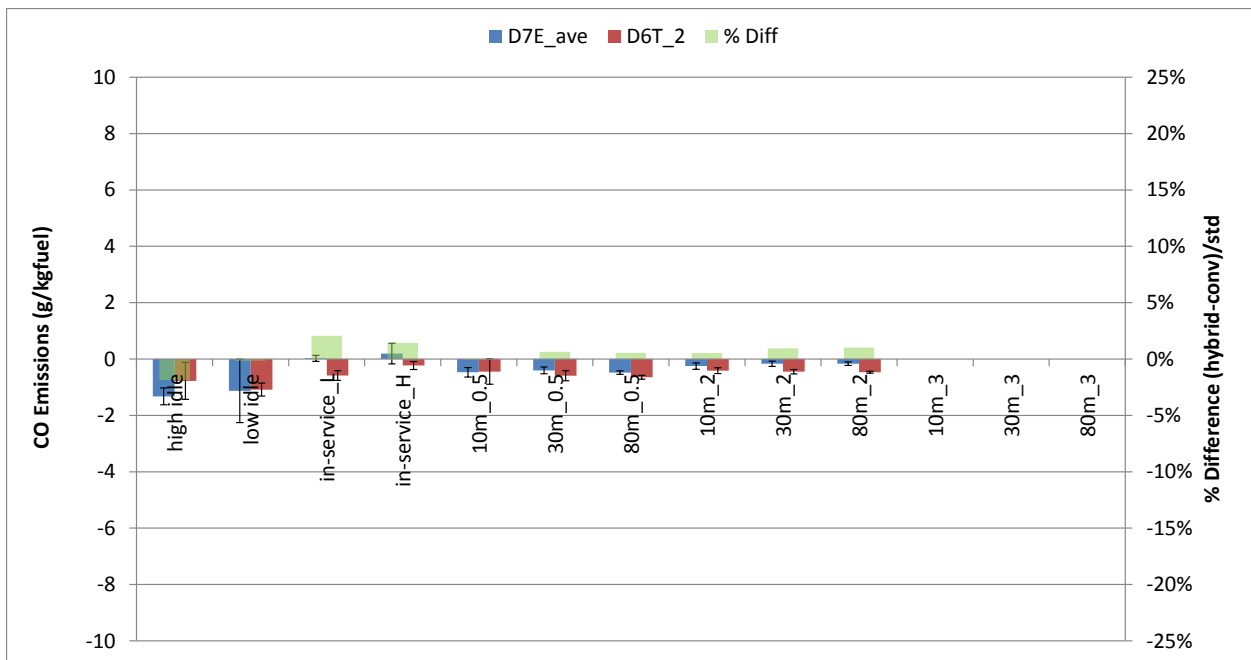
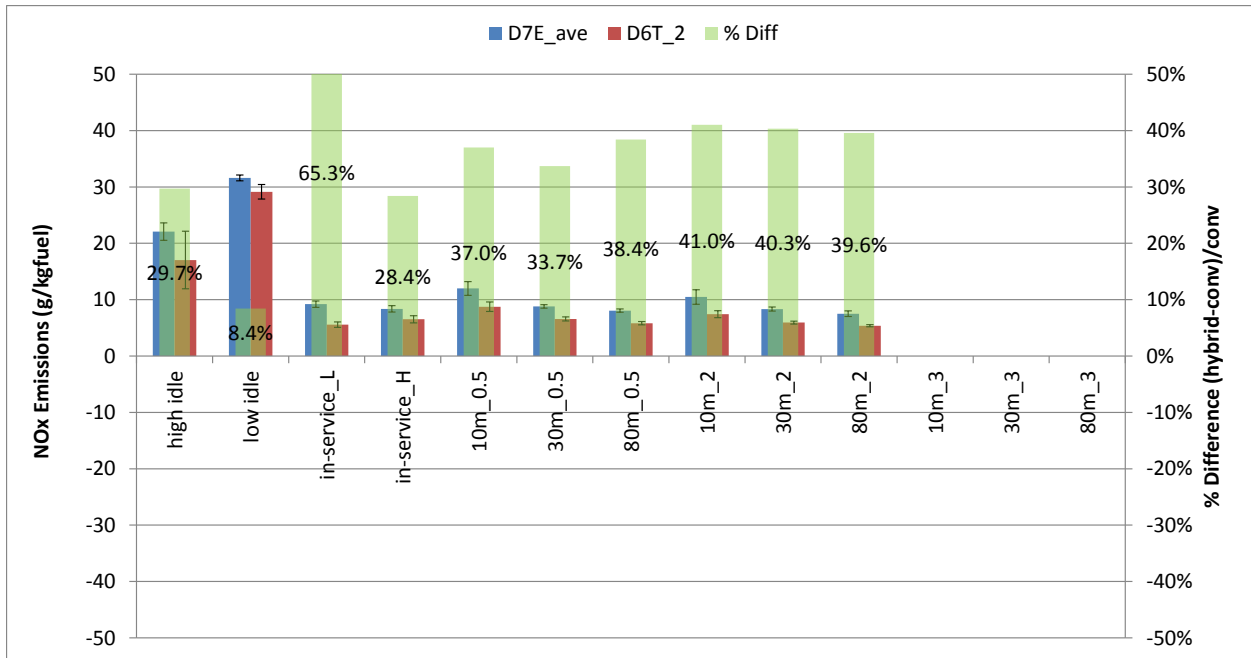
The controlled pull test result was collected at the WM's landfill. The results in g/hr and g/ton are already presented in bulldozer results section; hence, this section will only present the supplementary result in g/kgfuel and g/hp-hr.

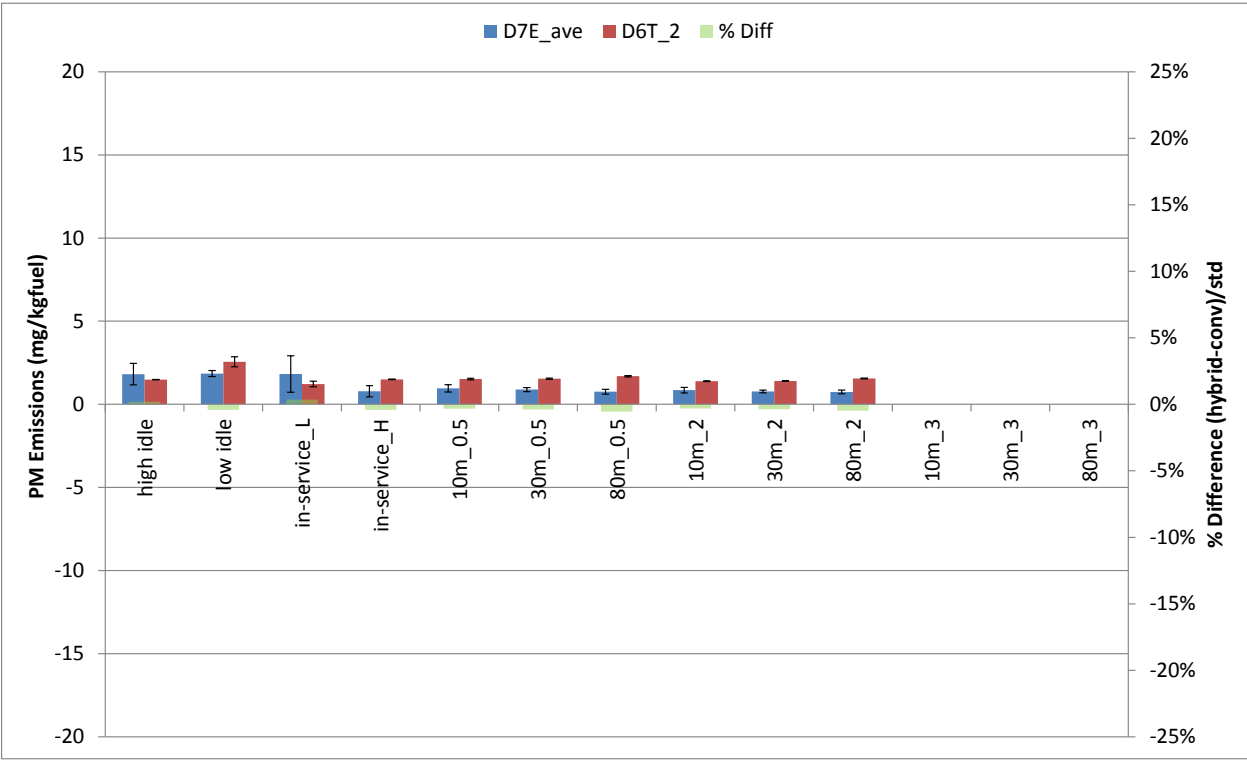
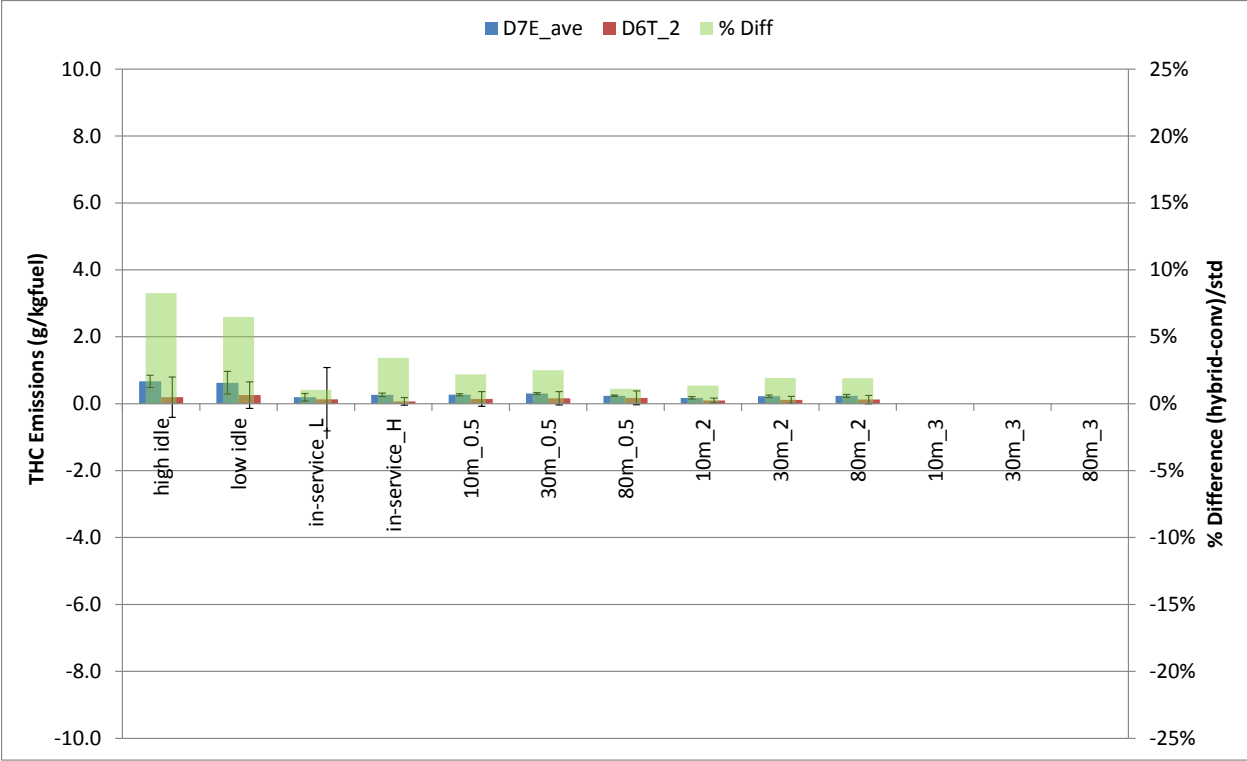
#### 1.2 Fuel Specific Emission (g/kgfuel)

For fuel specific emission the NO<sub>x</sub> is showing the same trend. PM, CO, and THC emissions are too low to observe any reliable trend due to presence of DPF and DOC.



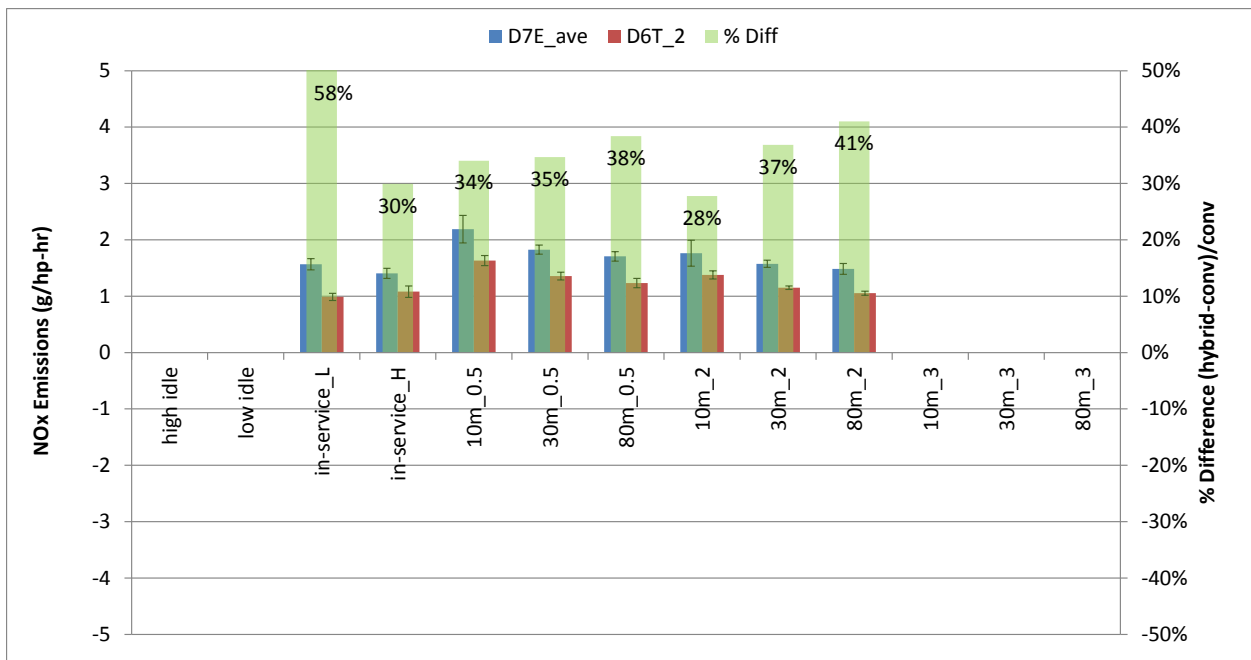
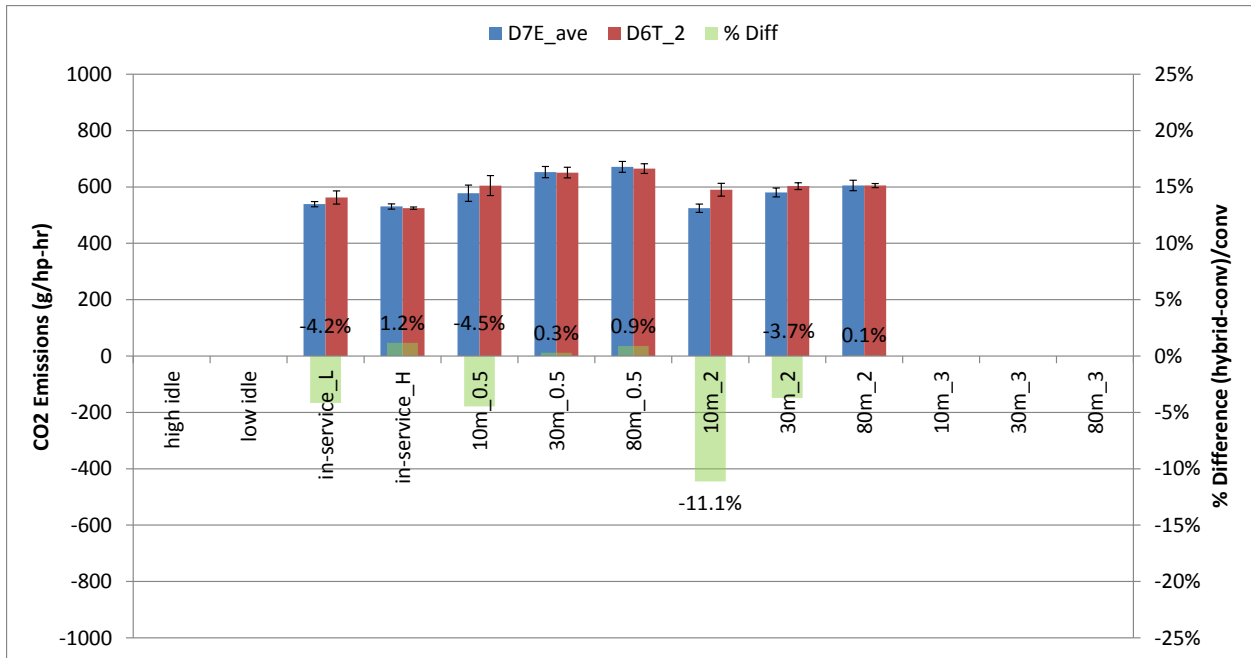


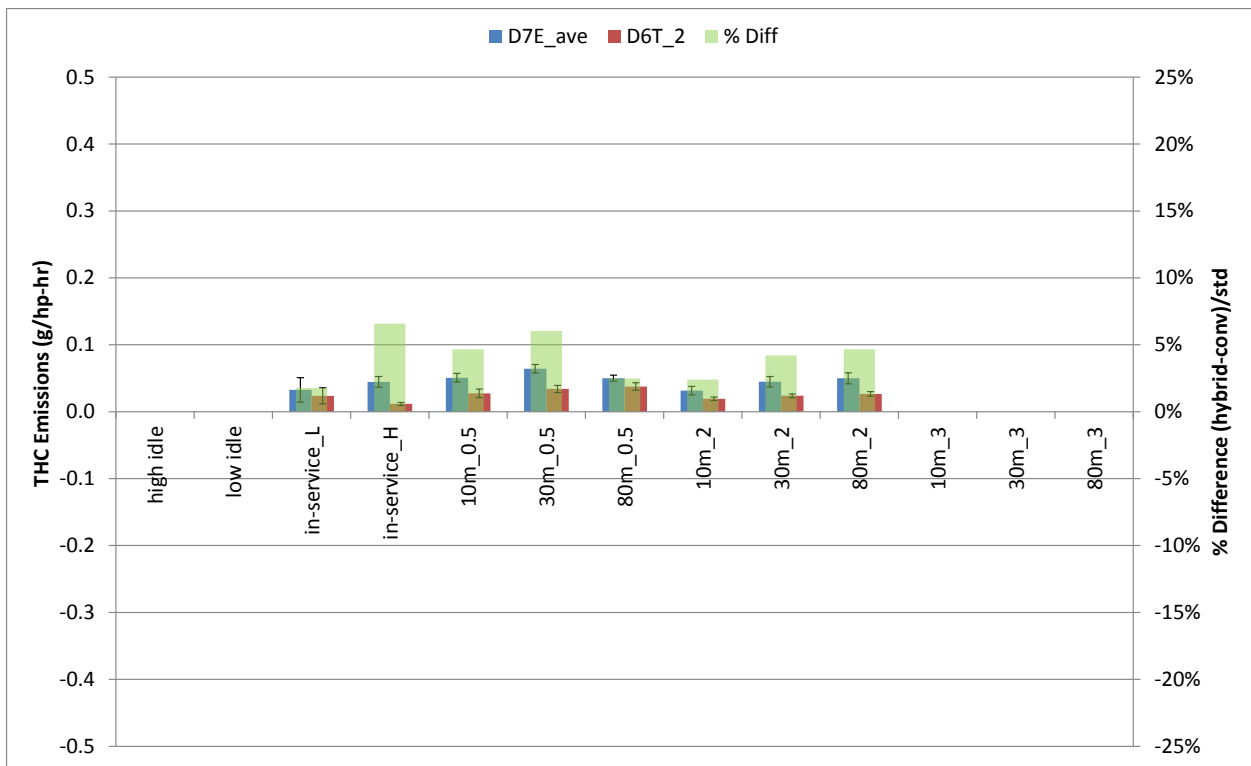
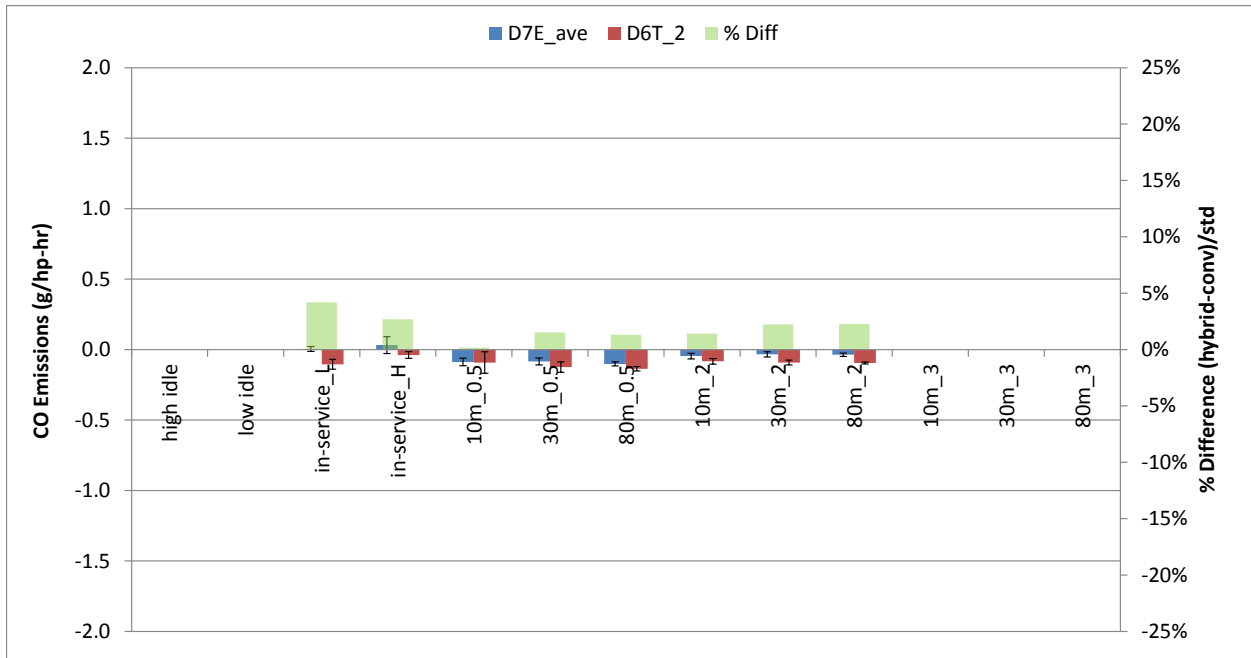


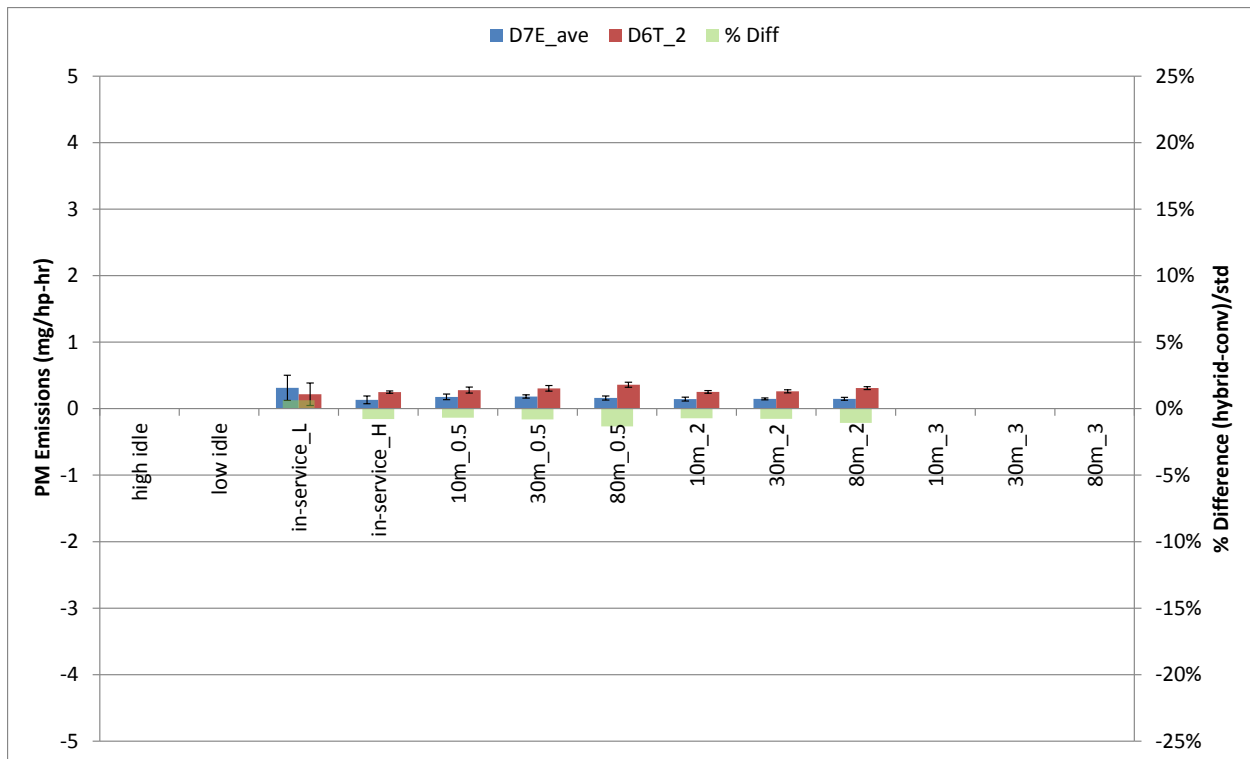


**1.3. Brake Specific Emission (g/kgfuel)**

Brake specific CO<sub>2</sub> is about the same for both units. bsNO<sub>x</sub> emissions showed similar increasing trend.







## 1.4 Controlled in-use test results

The bulldozer controlled in-service testing was conducted at the levees of Santa Ana River near Anaheim, CA on December 11<sup>th</sup> to 12<sup>th</sup> of 2012. Two different activities were evaluated for both the D7E and the D6T. Below are the supplemental results that was not presented the emission results section in the main report.

### 1.4.1 Time Specific Emissions (g/hr)

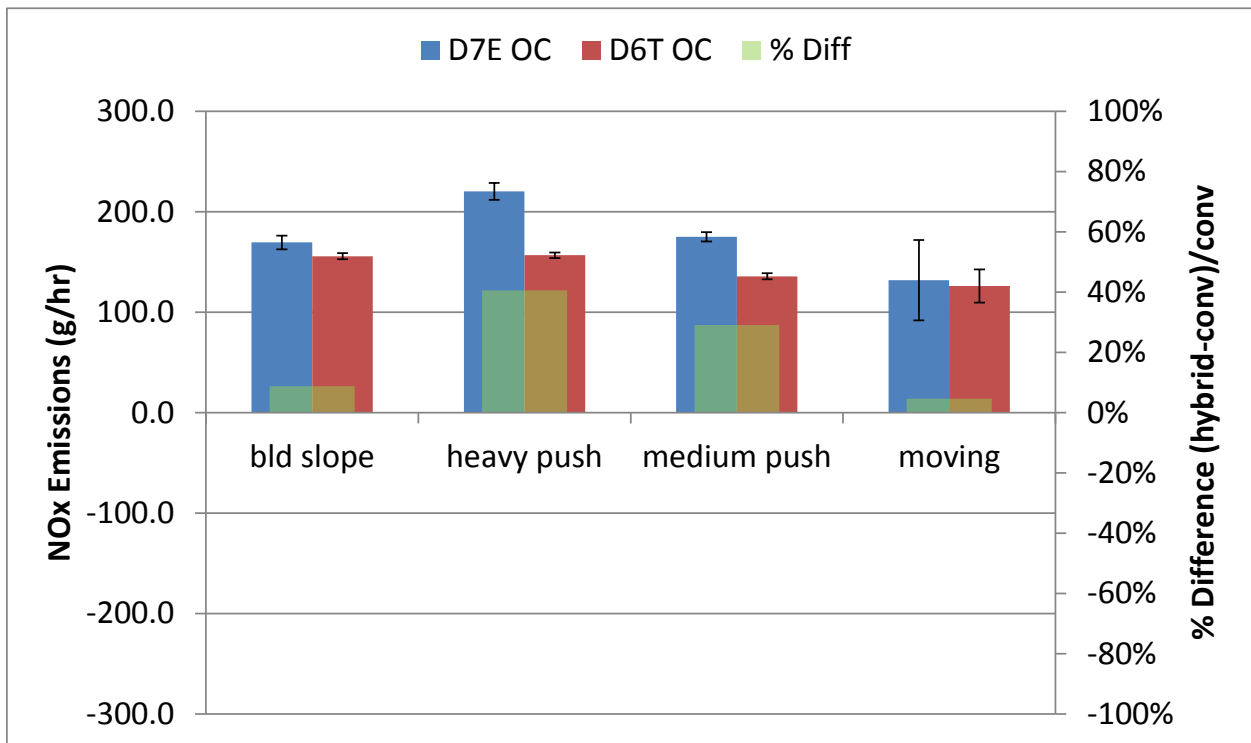
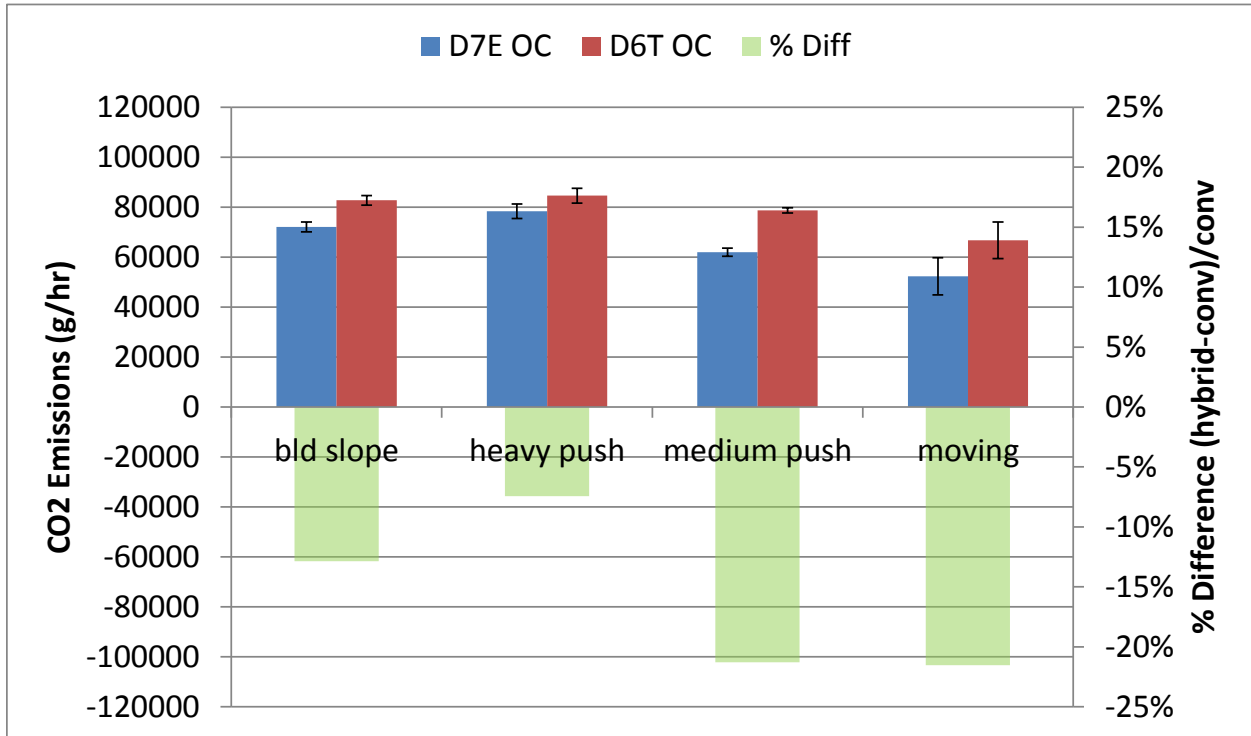
Gaseous and PM second by second emissions were measured by PEMS system; instantaneous mass emissions in g/sec were normalized to g/hr.

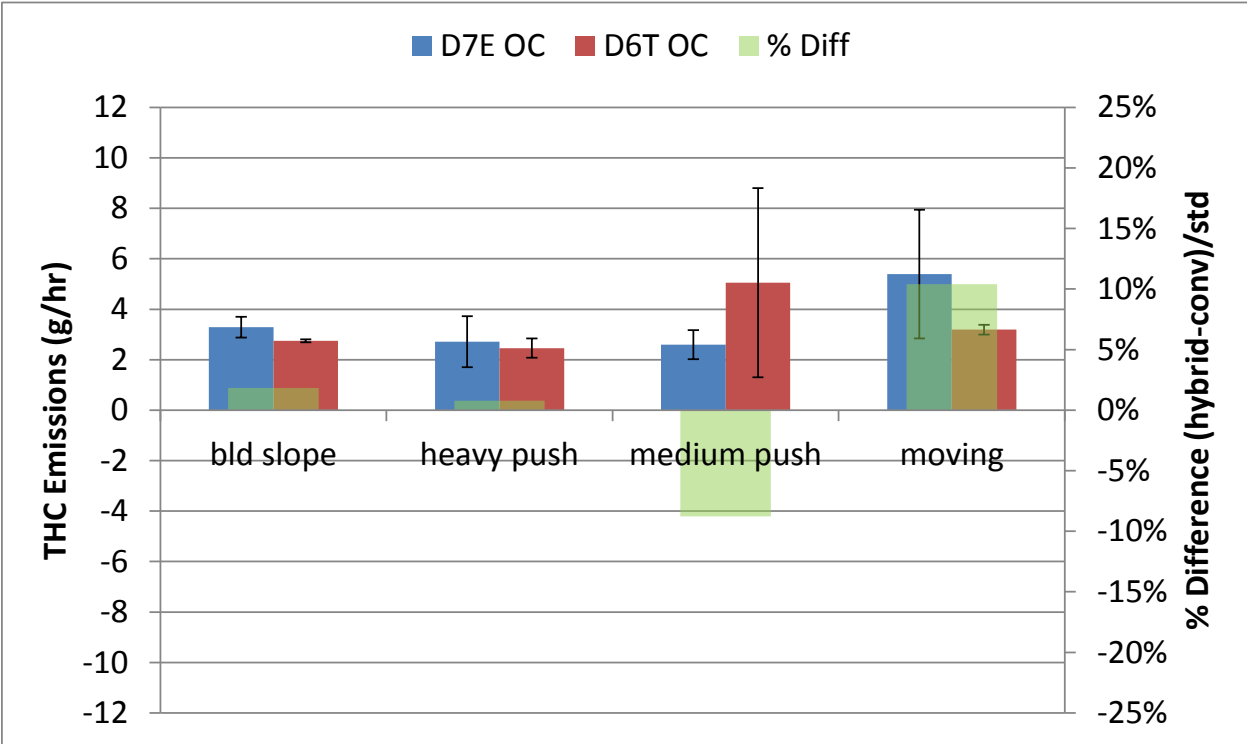
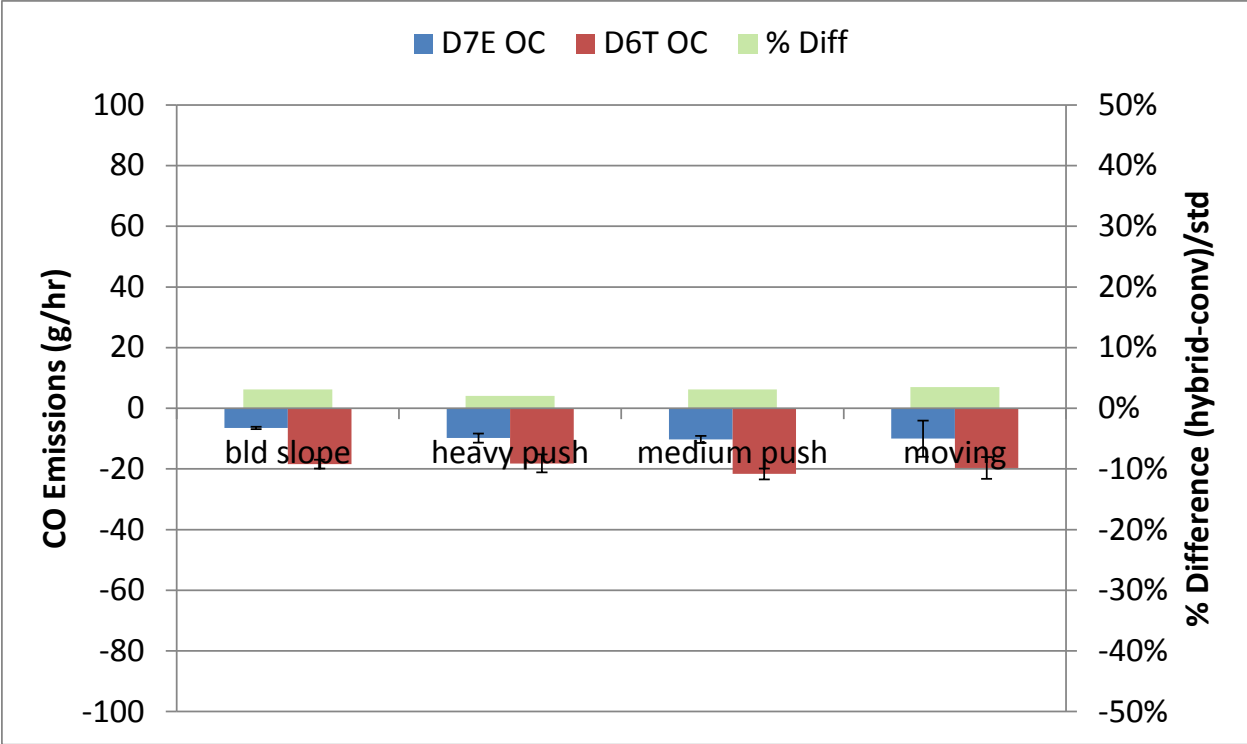
The Orange County's (OC) D7E showed 10% to 25% benefit in CO<sub>2</sub> emissions on mass per time basis depending on working mode despite it's a larger machine than the D6T. Out of the 3 working activity comparison, the lighter work medium push showed the largest benefit (~22%). As working load increase, the benefit becomes less in the 10% range. Idle mode showed the greatest benefit however the absolute difference was small.

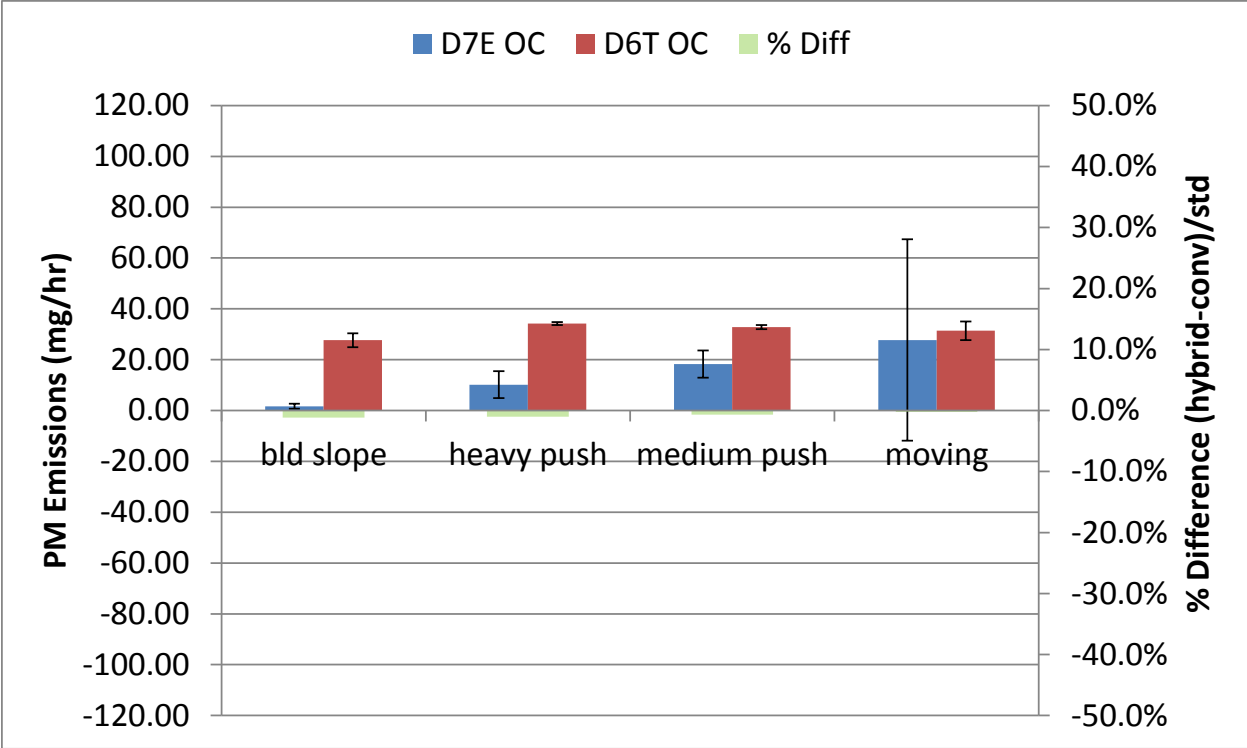
The Orange County's (OC) D7E showed 8% to 35% gain in NO<sub>x</sub> emissions on mass per time basis depending on activity mode. The heavier workload resulted in higher NO<sub>x</sub> penalty as expected. "Medium push" showed a higher NO<sub>x</sub> penalty than "bld slope" possible due to different RPM range and load factor on the engine. For the D7E, the RPM and % load for all activity were at 1700 rpm and 43% load. The D6T were at 1900 rpm and 63% load. The difference is solely from the difference in the drivetrain design of the the two bulldozers.

CO, THC, and PM emissions were low due to the presence of DPF on both machines. CO emissions in particular were so low that it was below detection limit of the insurements. PM

emissions for D7E showed some trends of possible benefit. However, the level of PM concentration was too load for confirm, the benefit could be resulted from DPF efficiency.



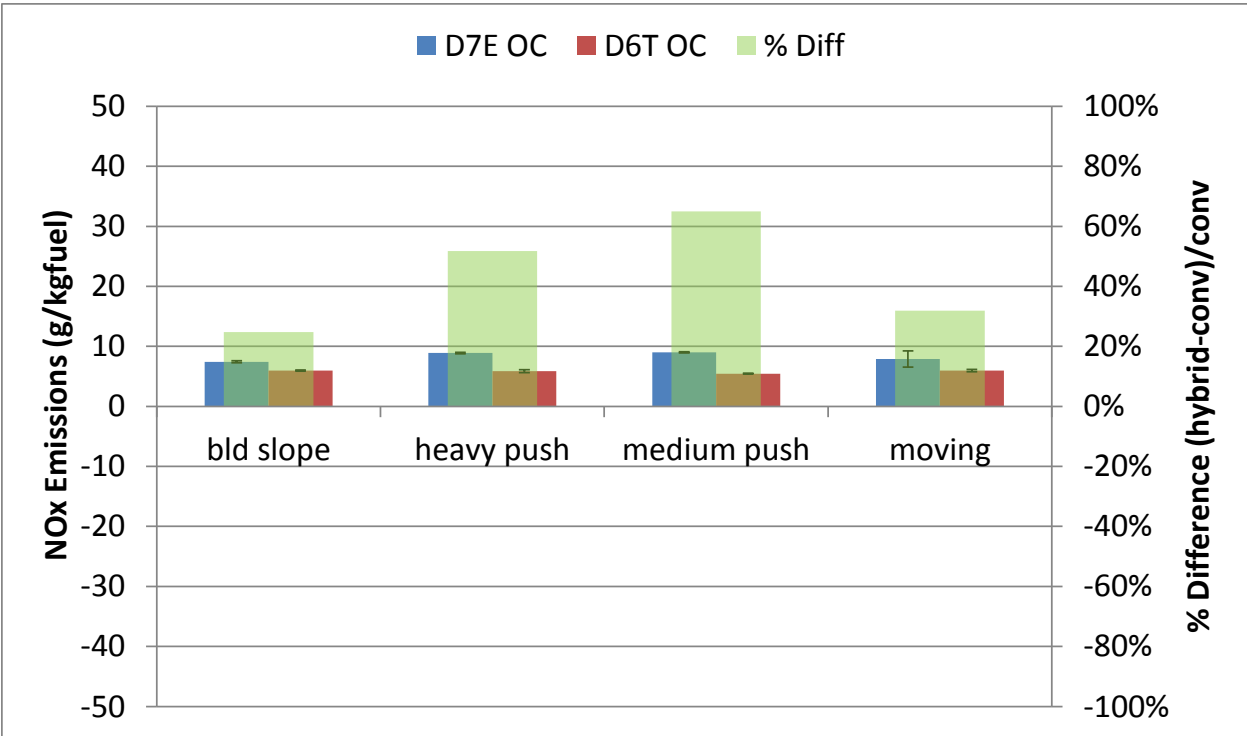
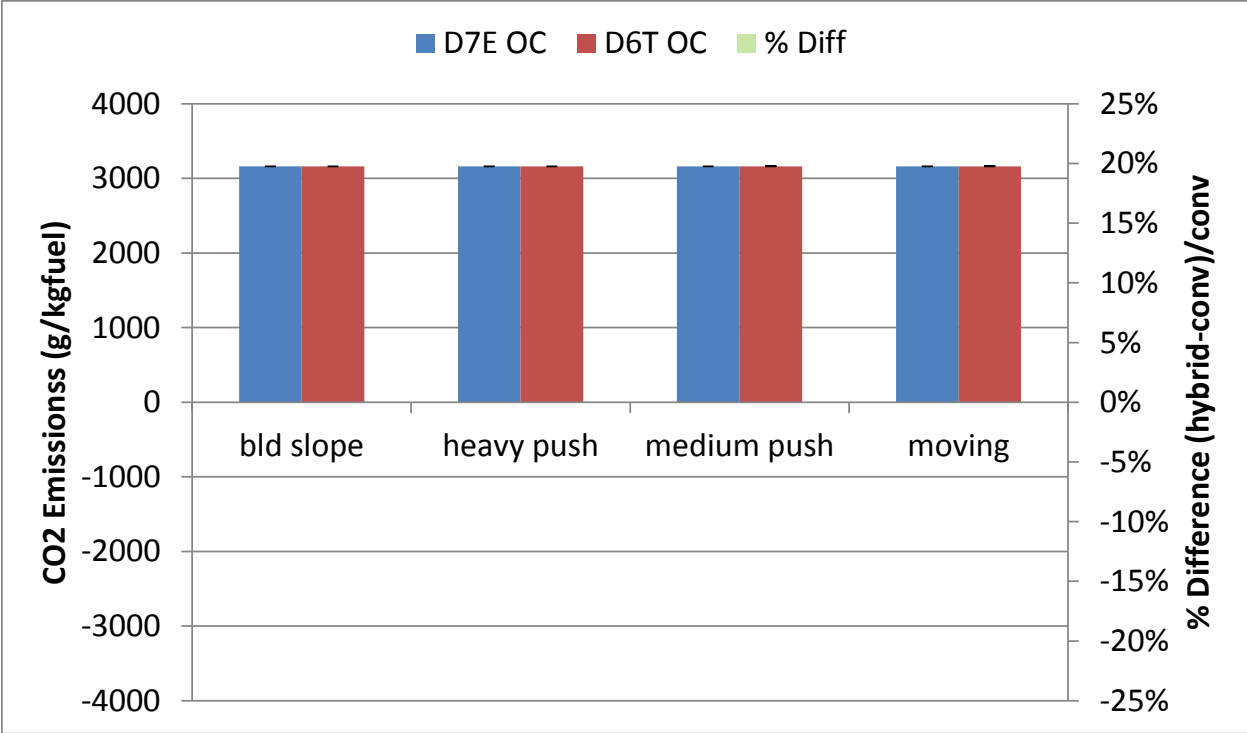


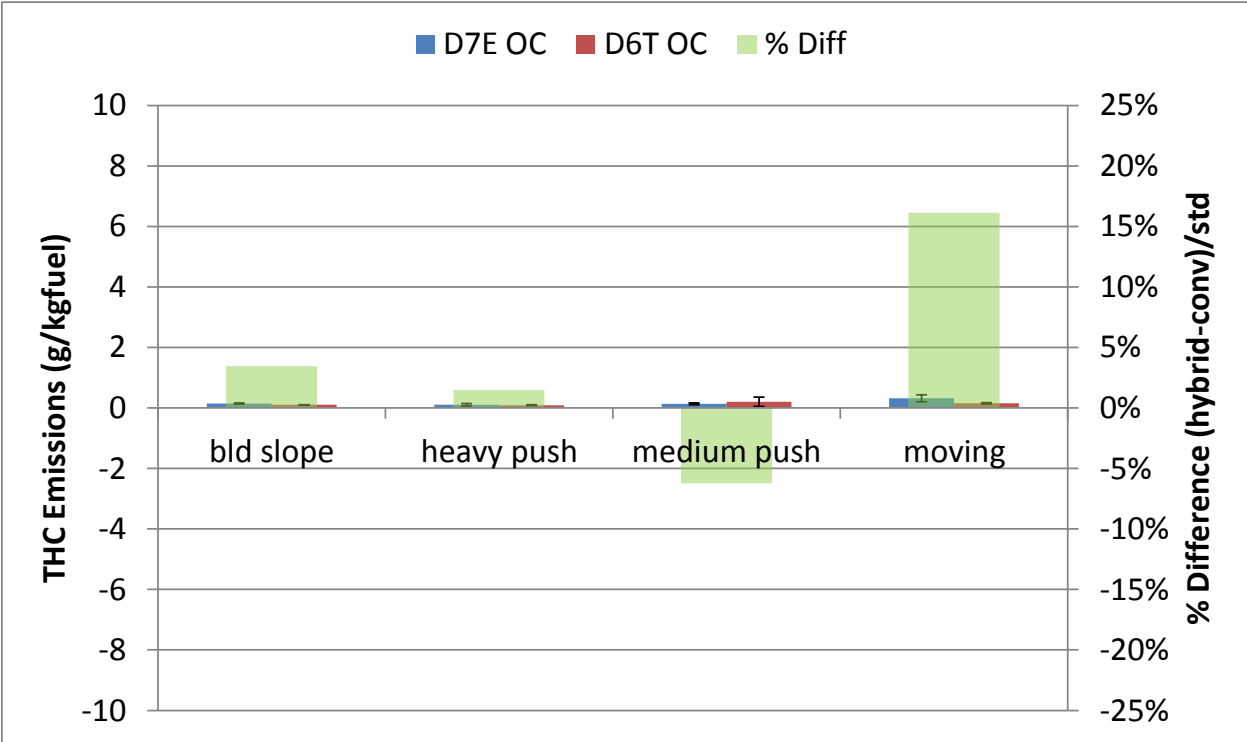
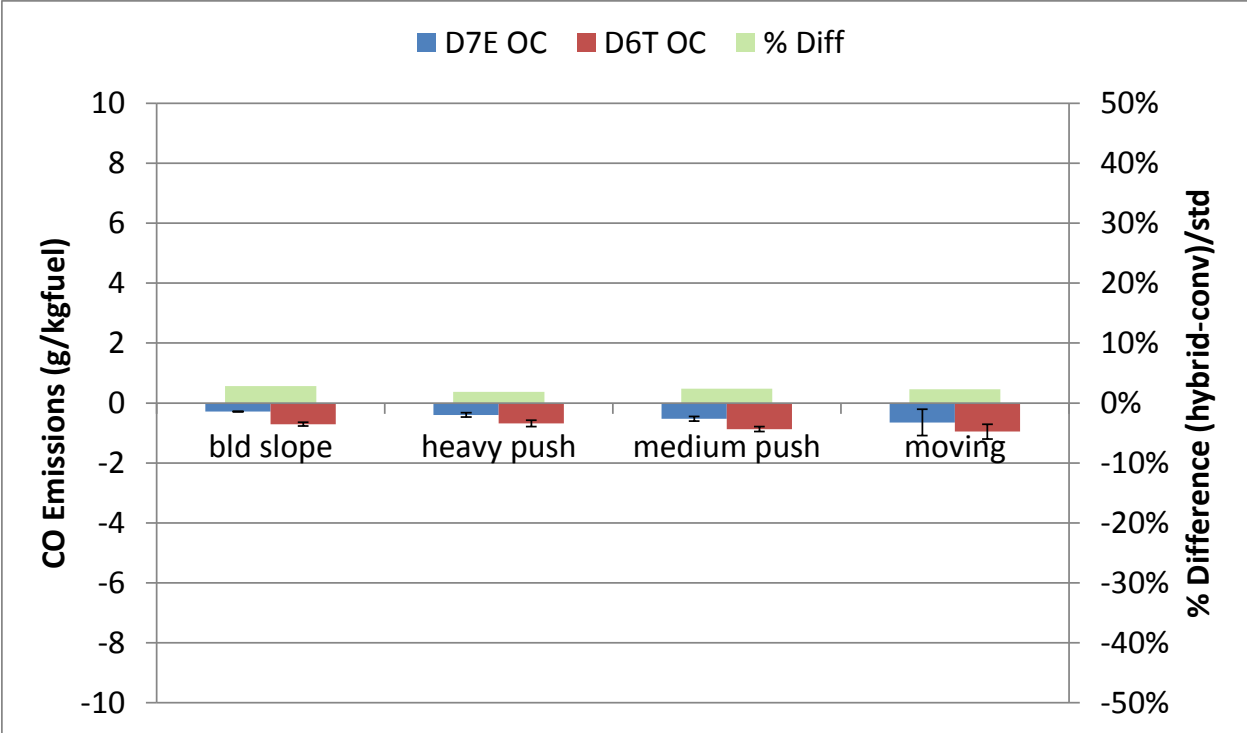


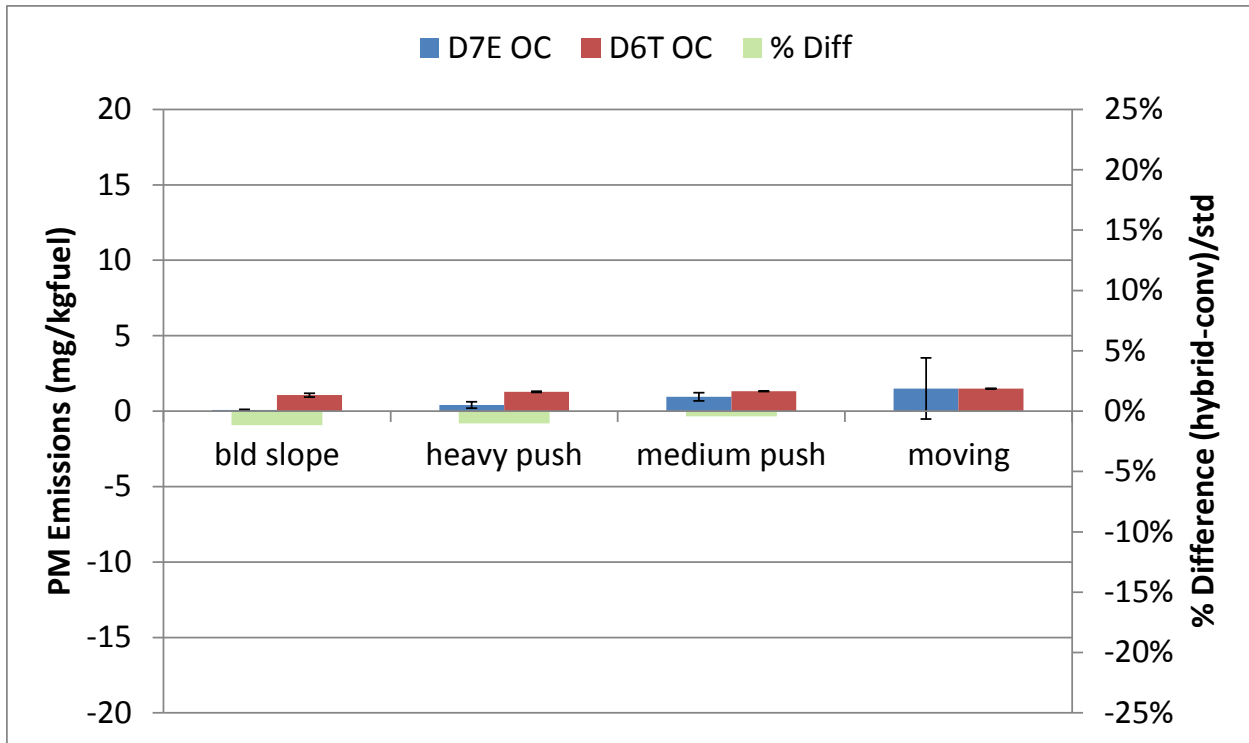
*1.4.2 Fuel Specific Emission (g/kgfuel)*

The Fuel specific CO<sub>2</sub> emissions are very tight around 3150 g/kgfuel. This is expected since the fuel rate was based on method 3 (carbon balance) calculations. Fuel specific NO<sub>x</sub> emissions show the same penalty of the hybrid but in larger fractions due to the less fuel consumption per mode for the hybrid. CO, THC, and PM emissions were very slow and showed no strong trend due to the presence of the DPF.





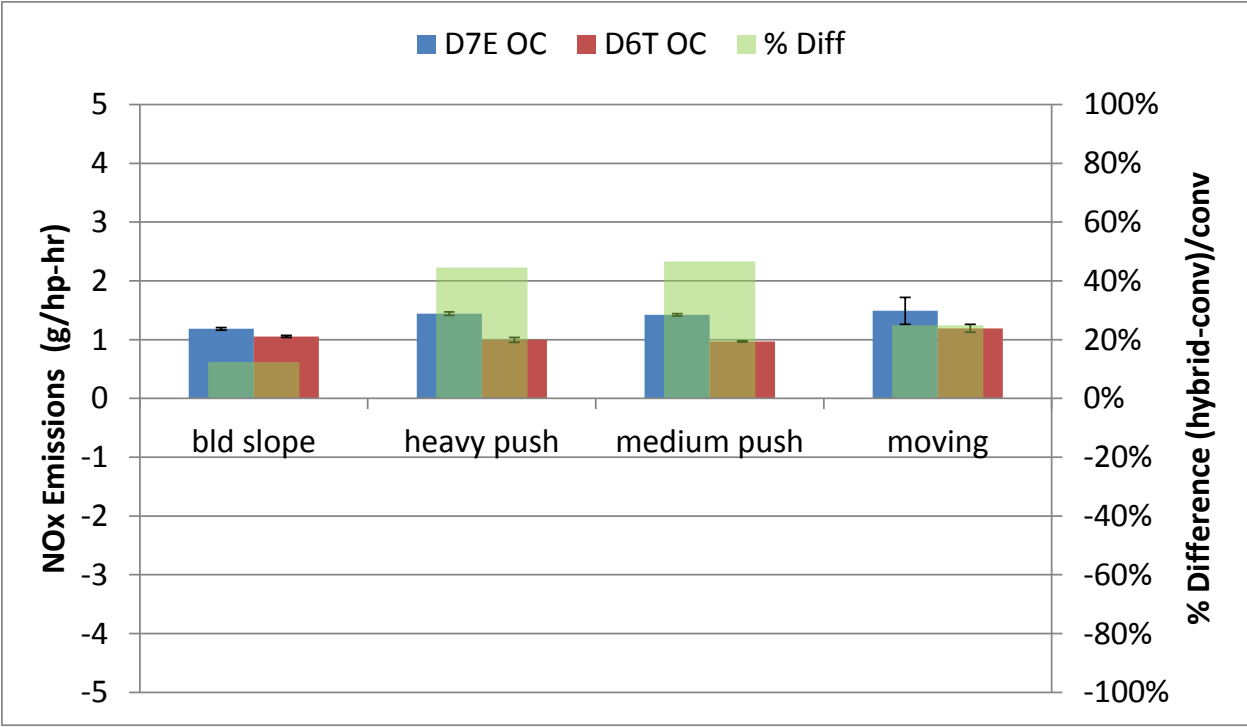
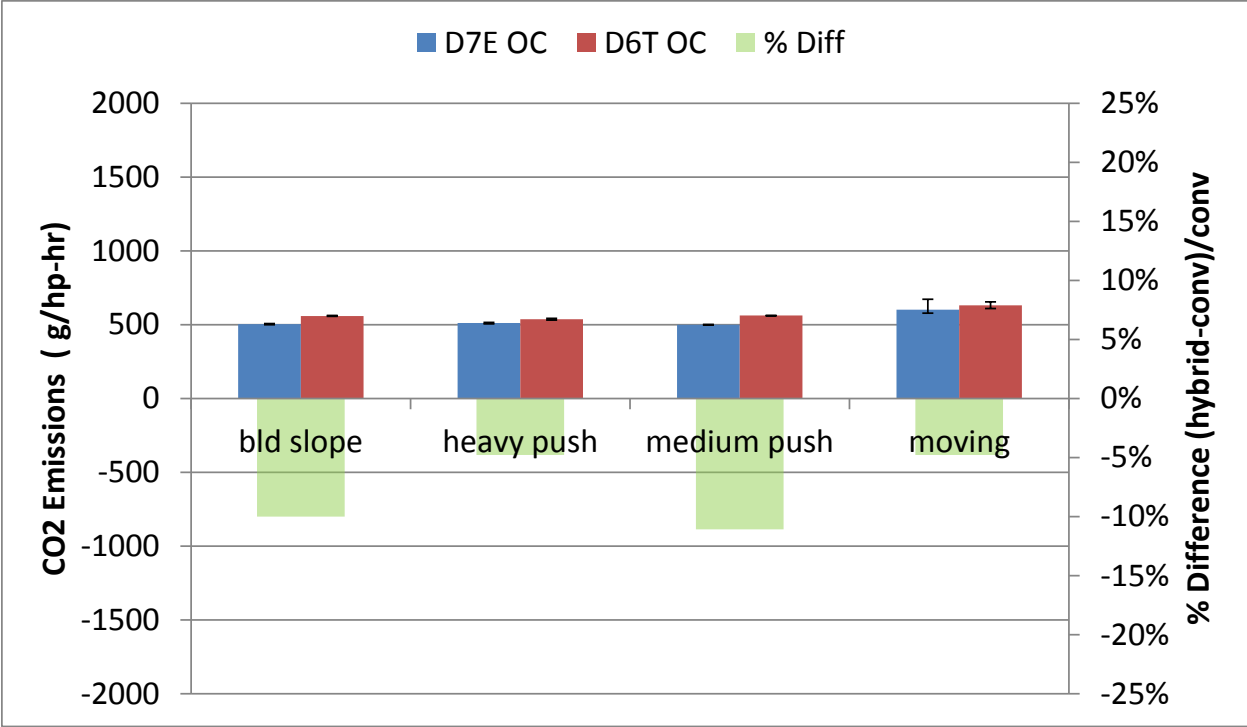


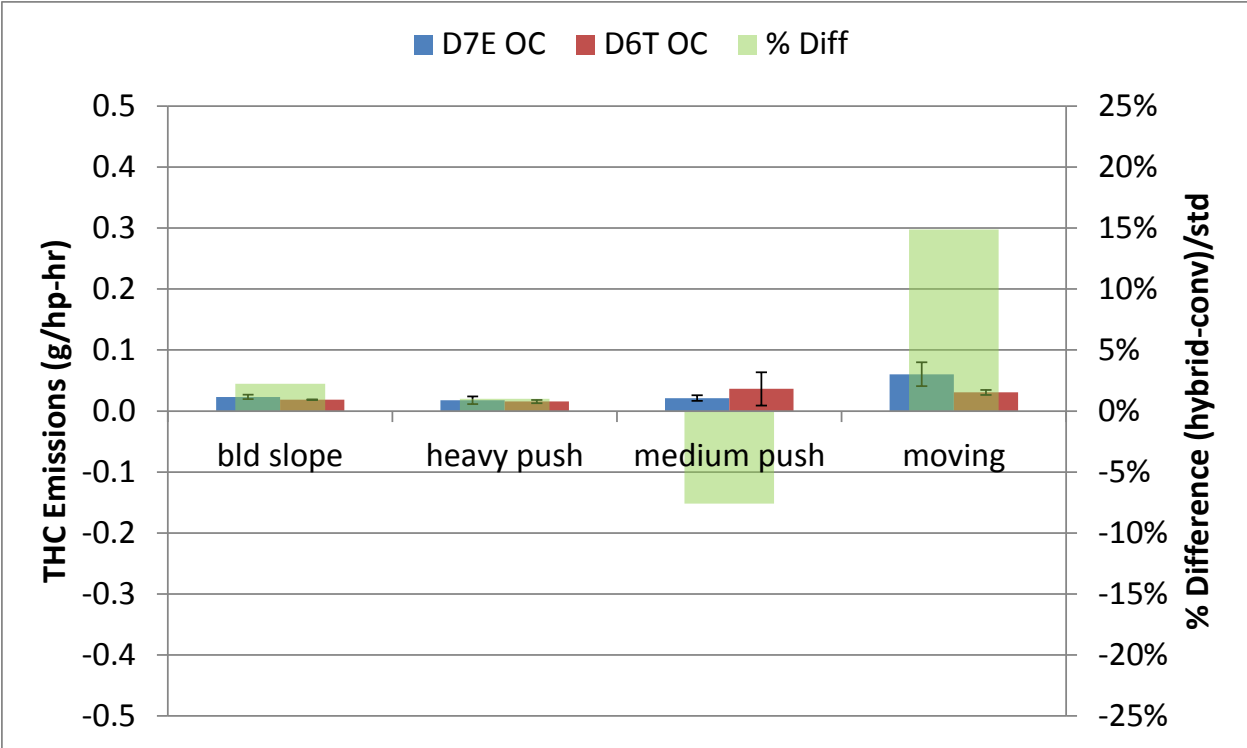
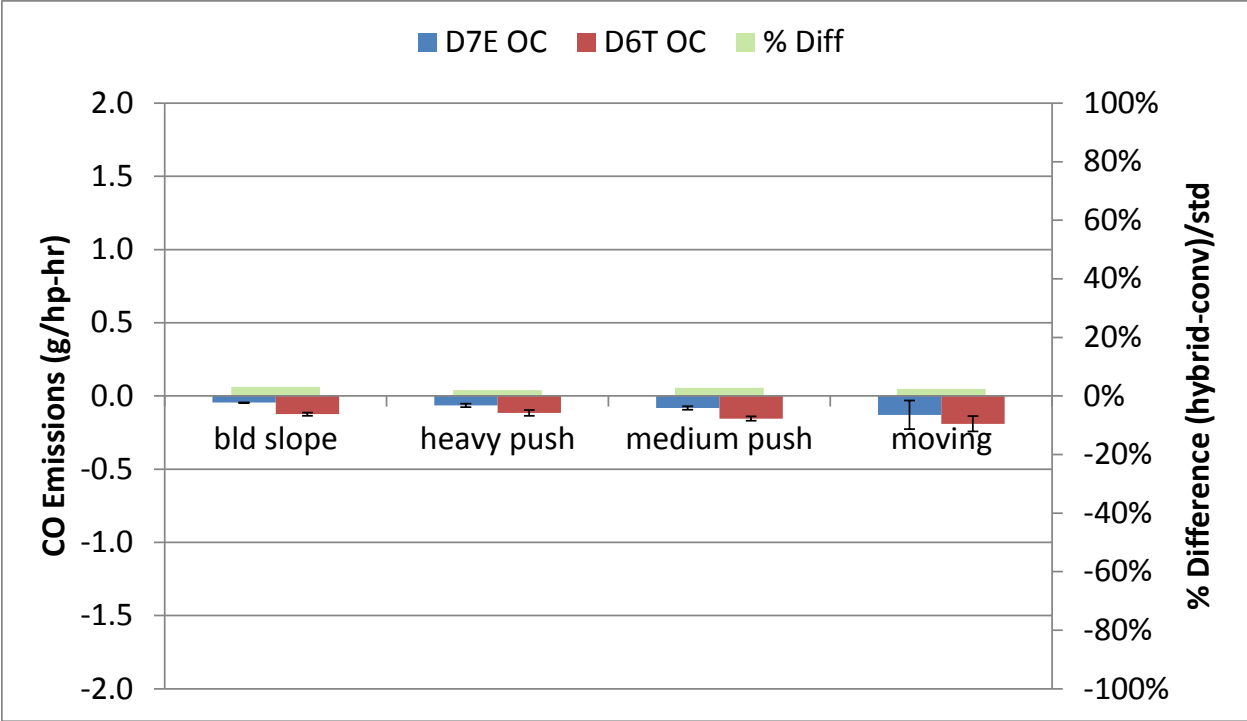


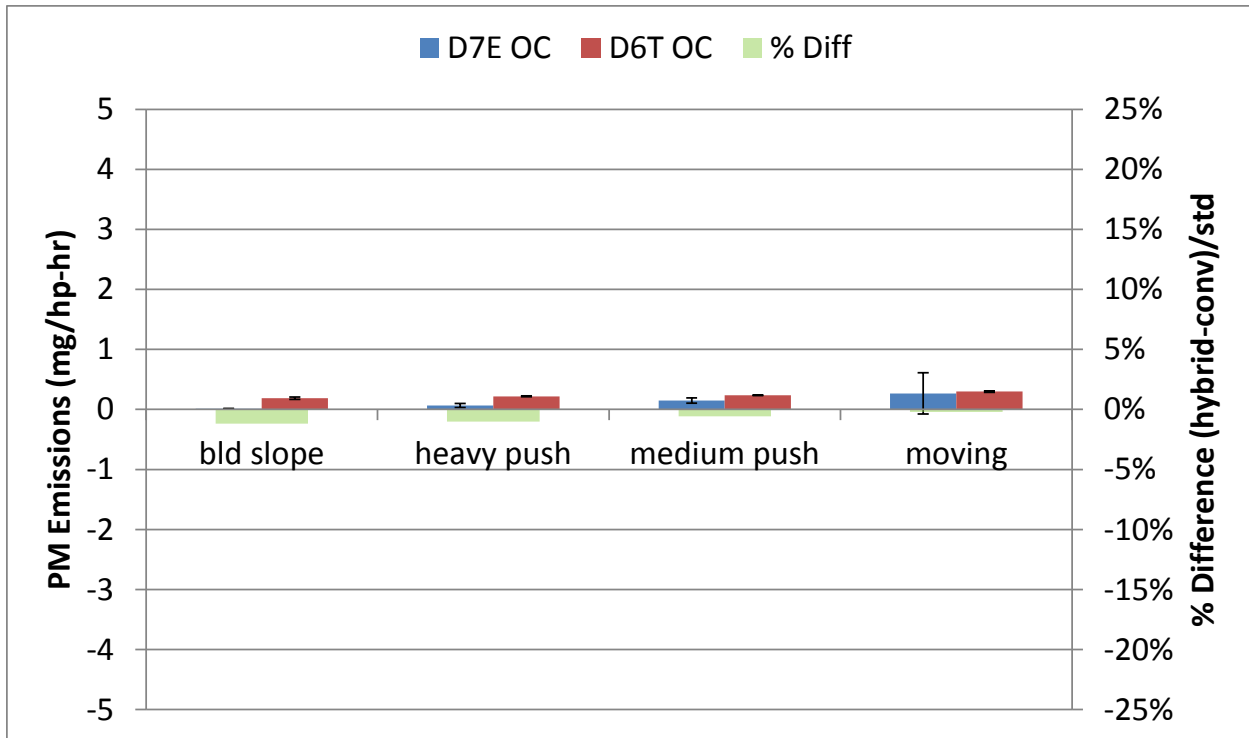
#### 1.4.3 Brake Specific Emission (g/hp-hr)

The brake specific CO<sub>2</sub> and NO<sub>x</sub> emissions showed the same trend. CO<sub>2</sub> emission showed anywhere between 5% to 12% benefit for the hybrid. At the same time, NO<sub>x</sub> emissions showed a 10% to 45% penalty. Despite the NO<sub>x</sub> penalty, the level is well below applicable emission standard.

CO, THC, and PM emissions were very low and well below the emission standard. The observed trends were not comparable due to DPF presence.







#### 1.4.4 Productivity Results

In this round of testing, UCR actually evaluated the two bulldozer's true in service performance. The D6T and D7E had the same C9.3 ACERT engine but it different in almost every other way.

The D6T is a rental unit equipped with 10.8 feet wide SU XL blade with a side extension made for more generalized application. The D6T XL model is equipped with high track with lifted sprocket for better ground clearance. The engine is coupled with a convention transmission.



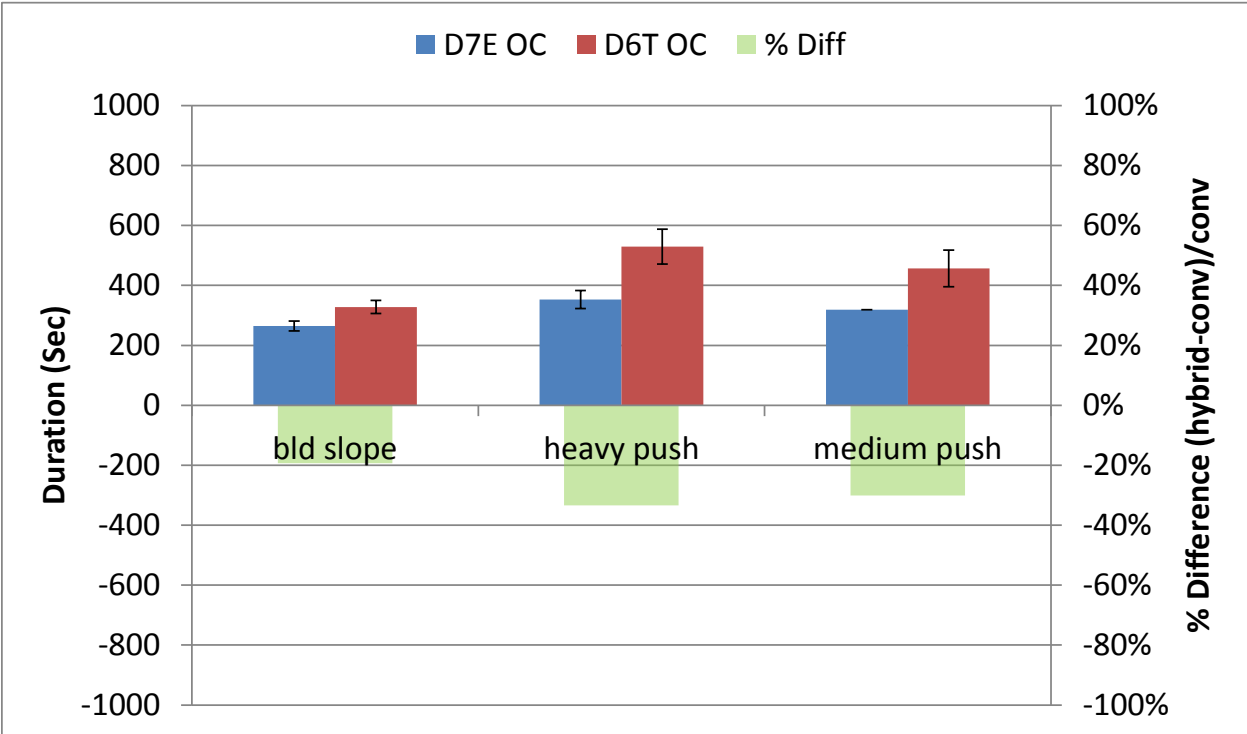
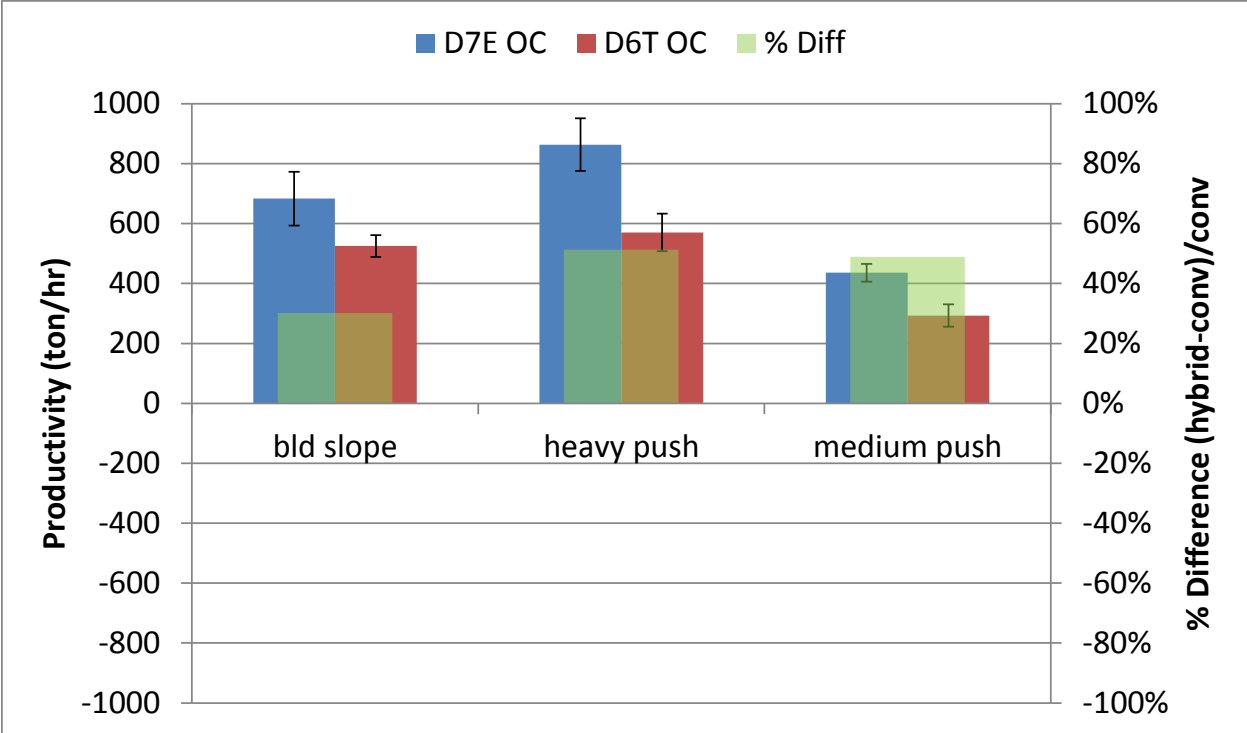
The OC D7E is an OC owned unit equipped with 15.2 feet wide variable radius blade custom made by Balderson Blade Co. The extra wide blade is specially fit for OC's day to day activity. The D7E drivetrain is entirely electric thus the engine power is utilized very differently than the D6T. This D7E is also a LGP model with extra wide track for work in the river.

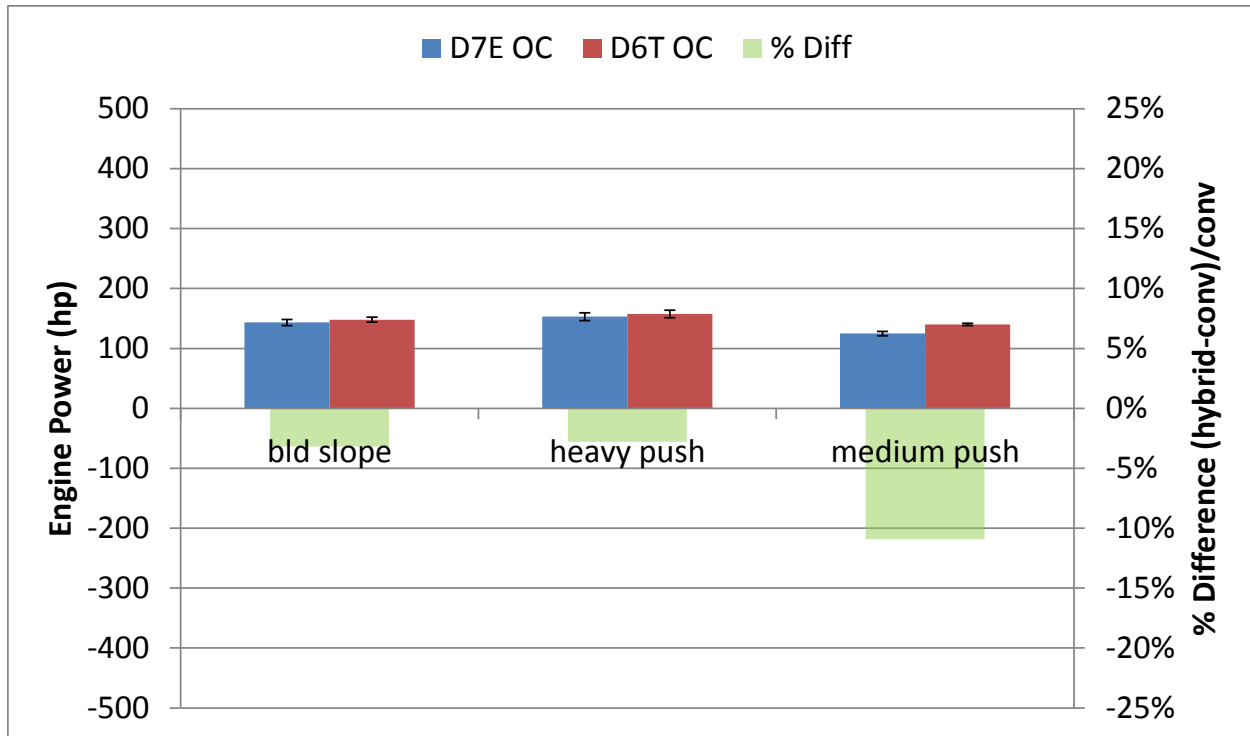






Since the OC D7E's larger blade is tailor to the in-service work, we expect the D7E to be slightly more productive than the D6T. In fact, our comparison test show that the D7E is about 30% to 50% more productive in term of ton of material moved per hour than the D6T. Again, this large benefit is not all due to the hybrid power train but rather a combined contribution from larger machine size, larger application specific blade, and experience operator.





## 2 D7E-T4i vs D8T-T4i Supplementary Results

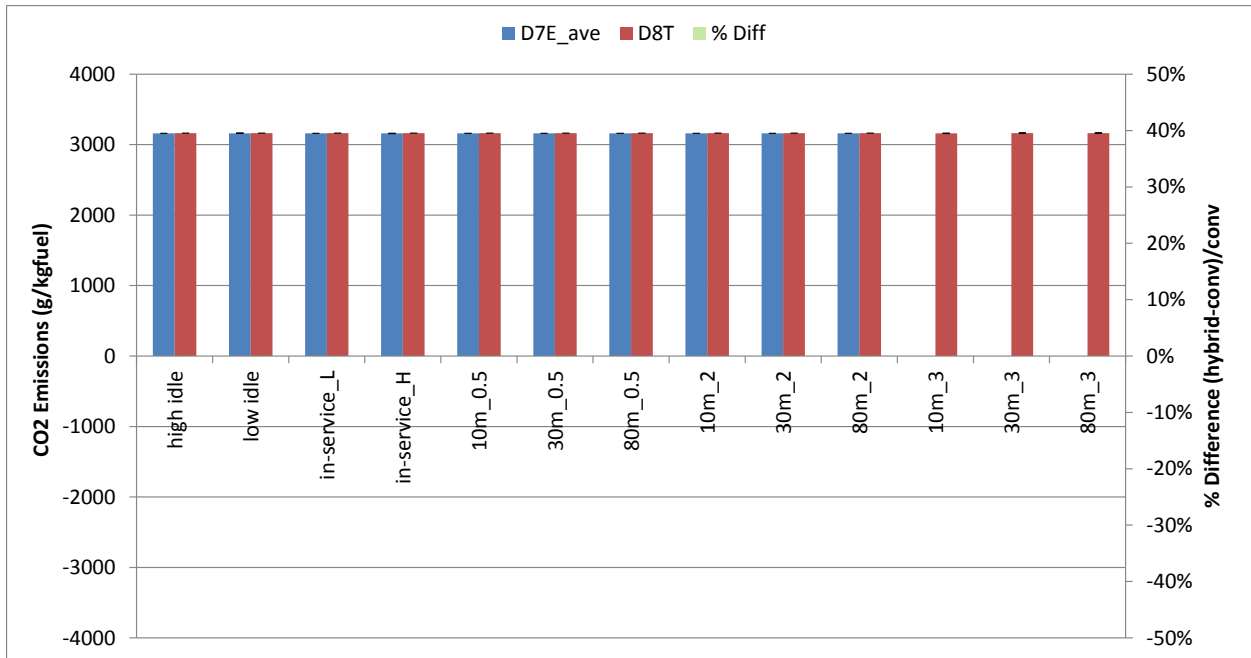
The results in g/hr and g/ton are already presented in bulldozer results section; hence, this section will only present the result in g/kgfuel and g/hp-hr. Only the control pull test was conducted between these two units.

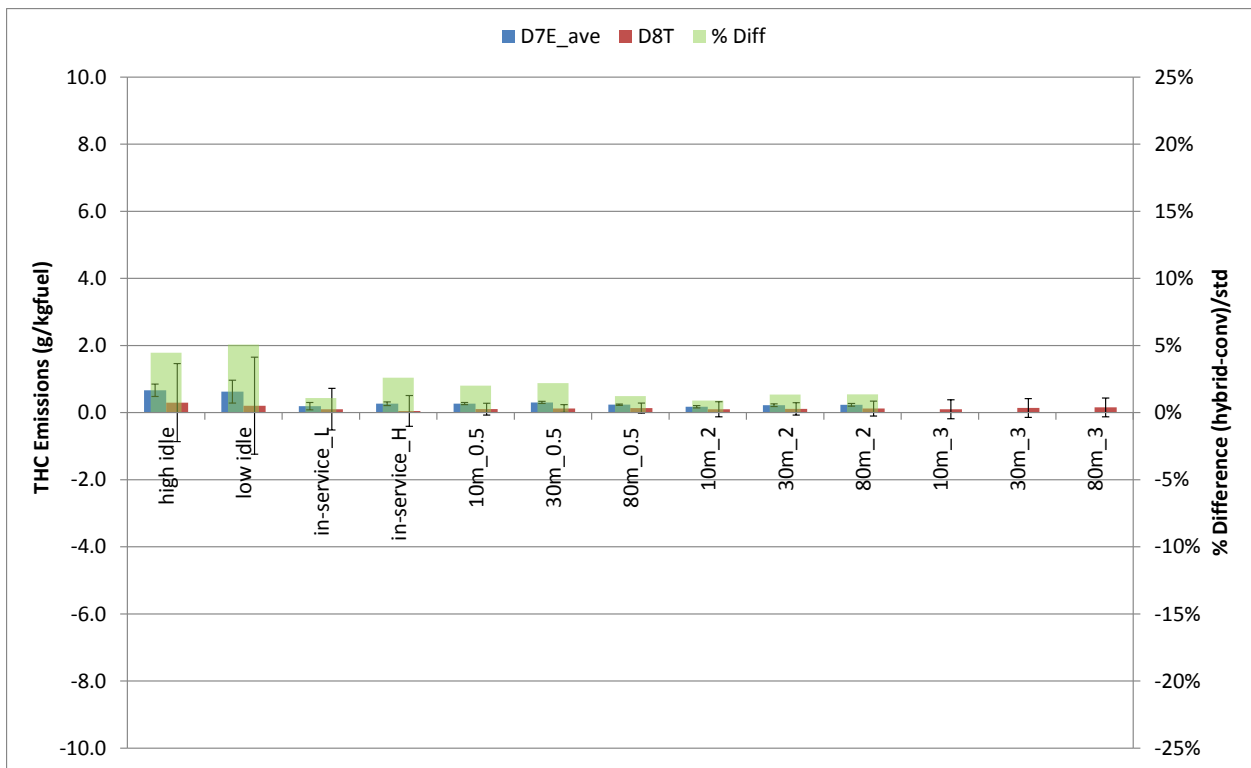
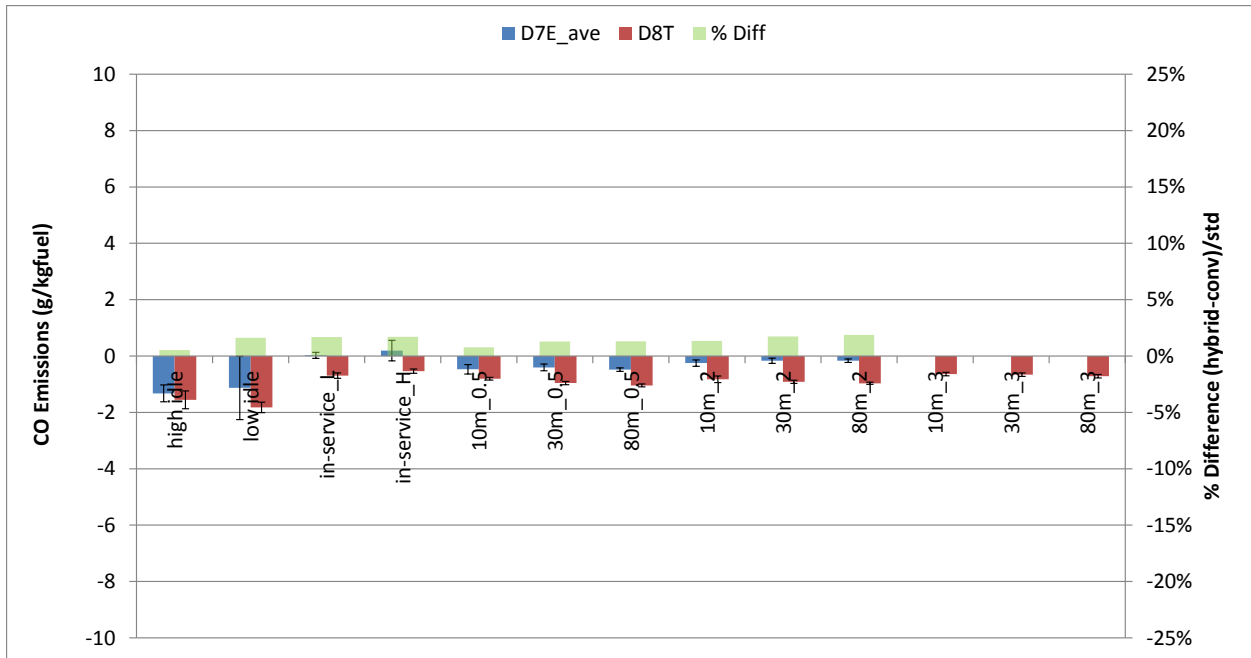
### 2.1 Controlled pull test results

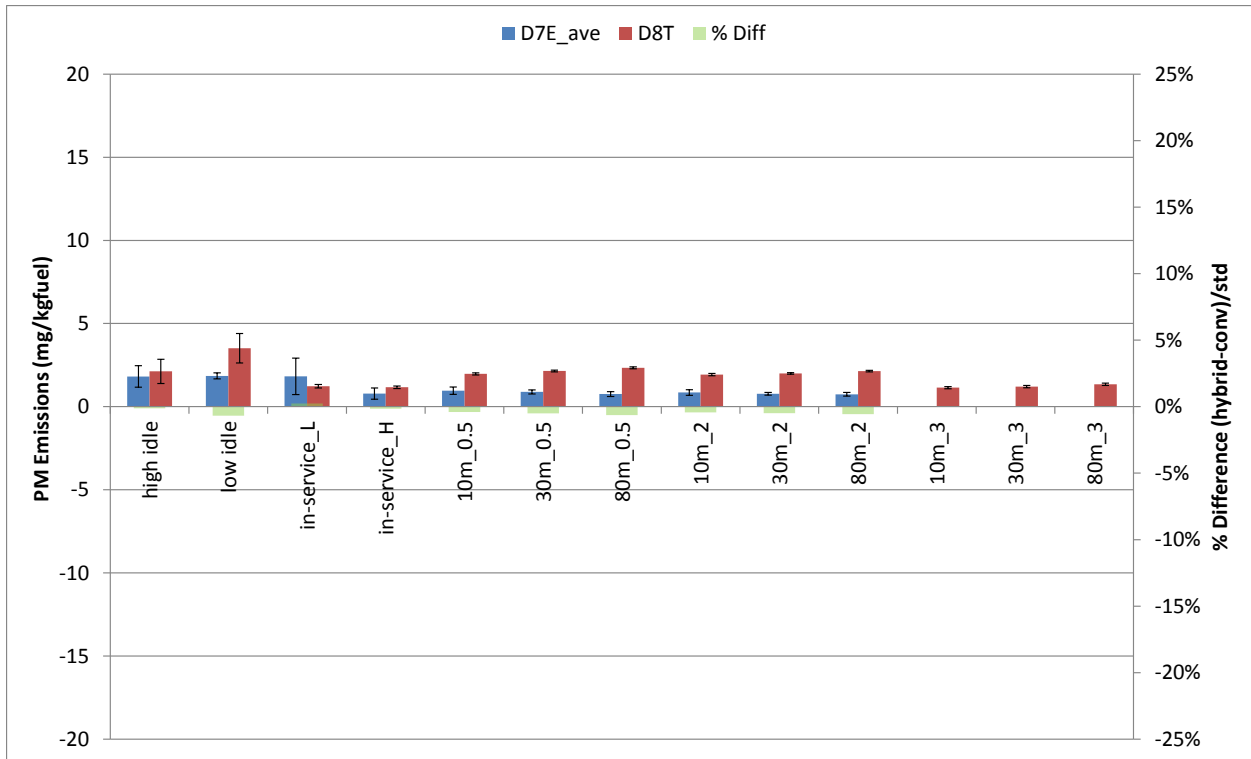
The pull test results for the D7E and D8T was also collected at the WM landfill.

#### 2.1.1 Fuel Specific Emission (g/kgfuel)

The Fuel specific CO<sub>2</sub> emissions are very tight around 3150 g/kgfuel. This is expected since the fuel rate was based on method 3 (carbon balance) calculations. Fuel specific NO<sub>x</sub> emissions show both benefit and penalty of the hybrid. CO, THC, and PM emissions were very slow and showed no strong trend due to the presence of the DPF.

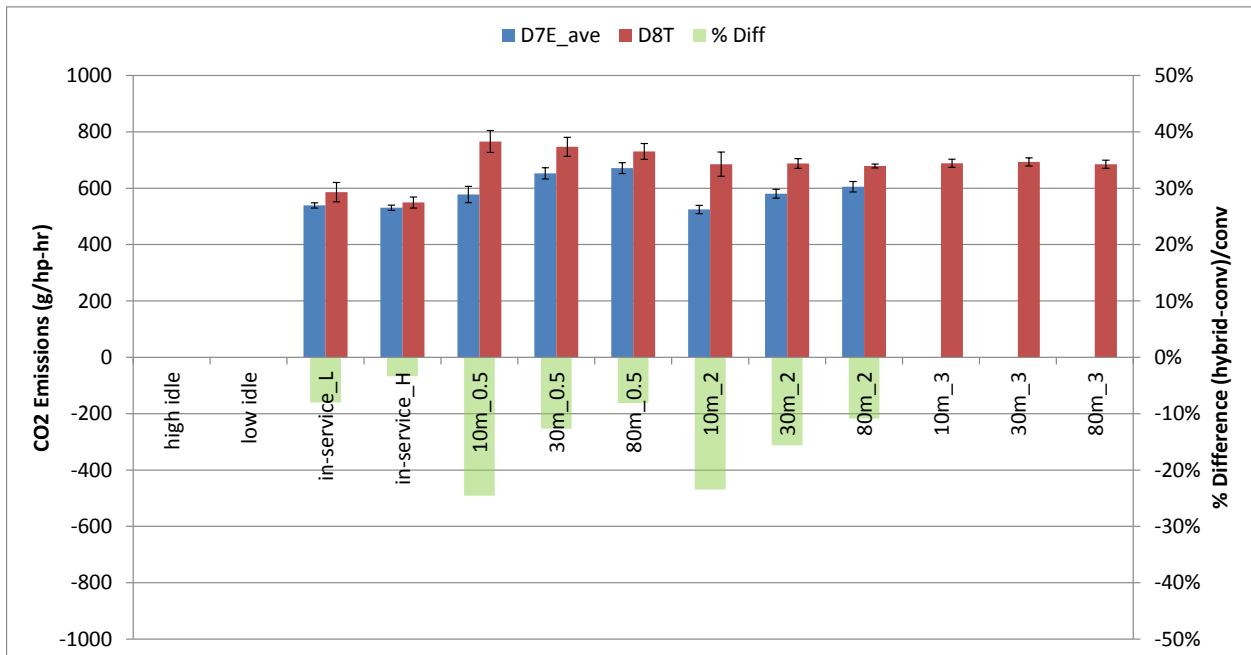


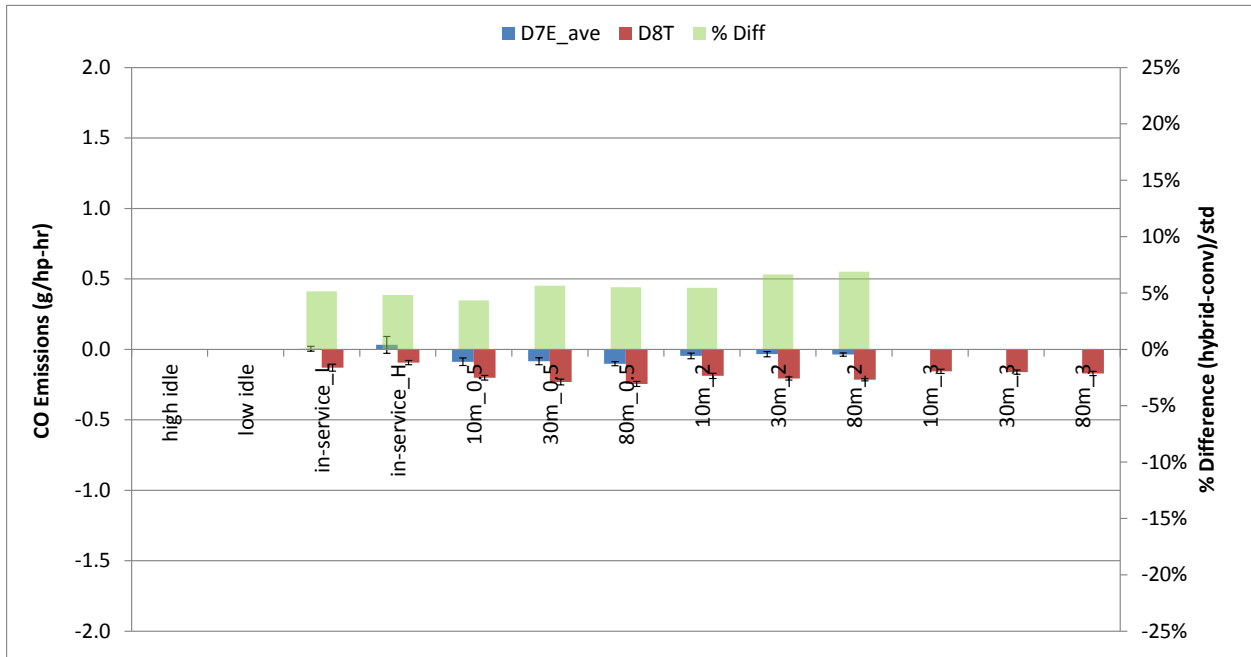
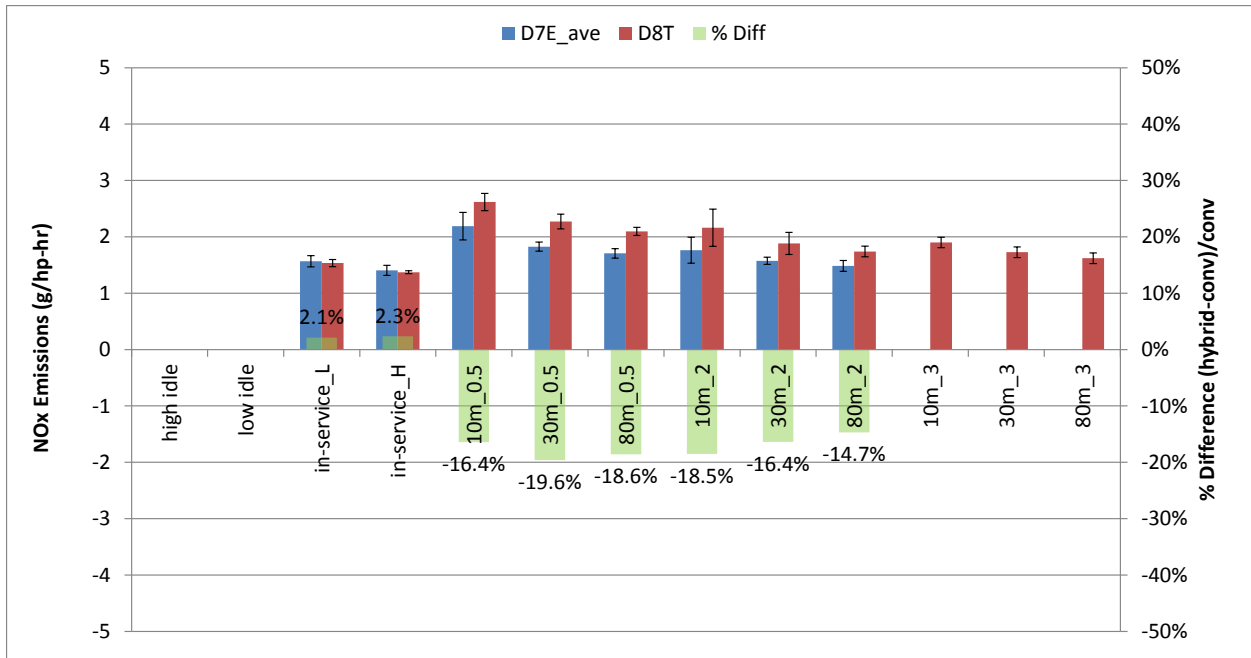


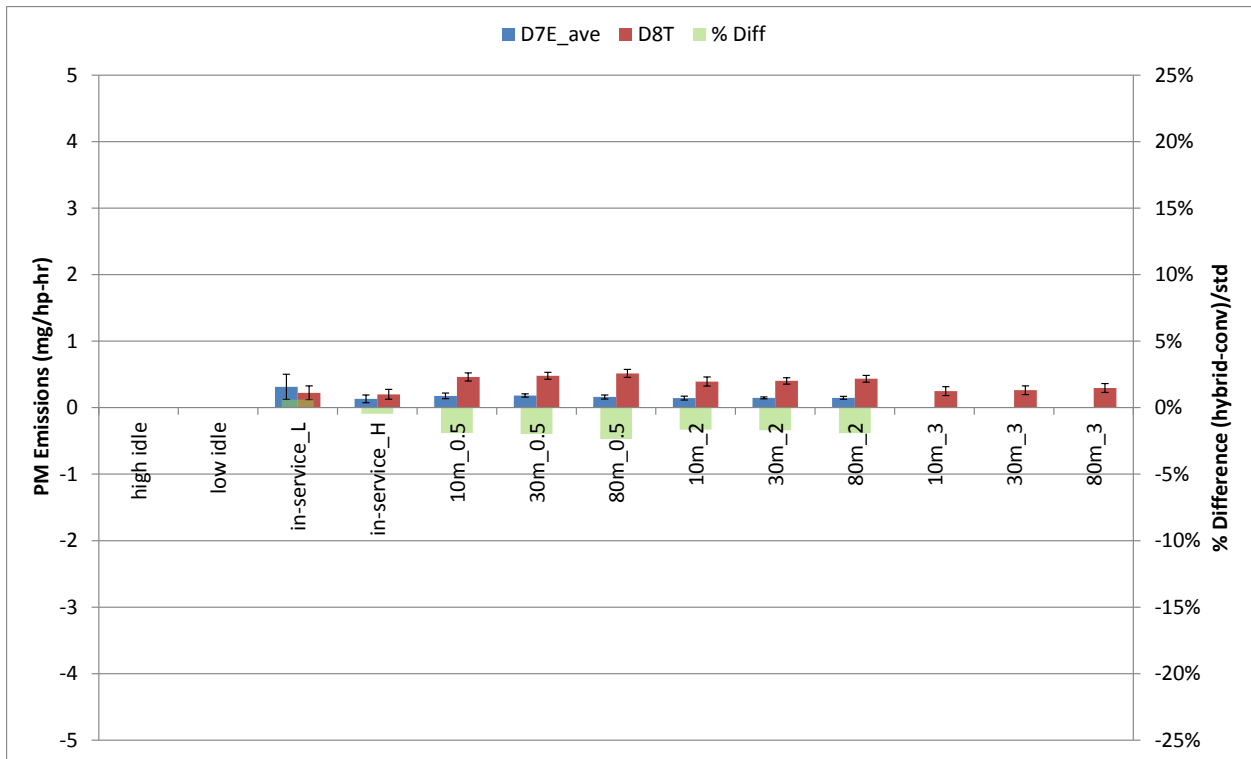
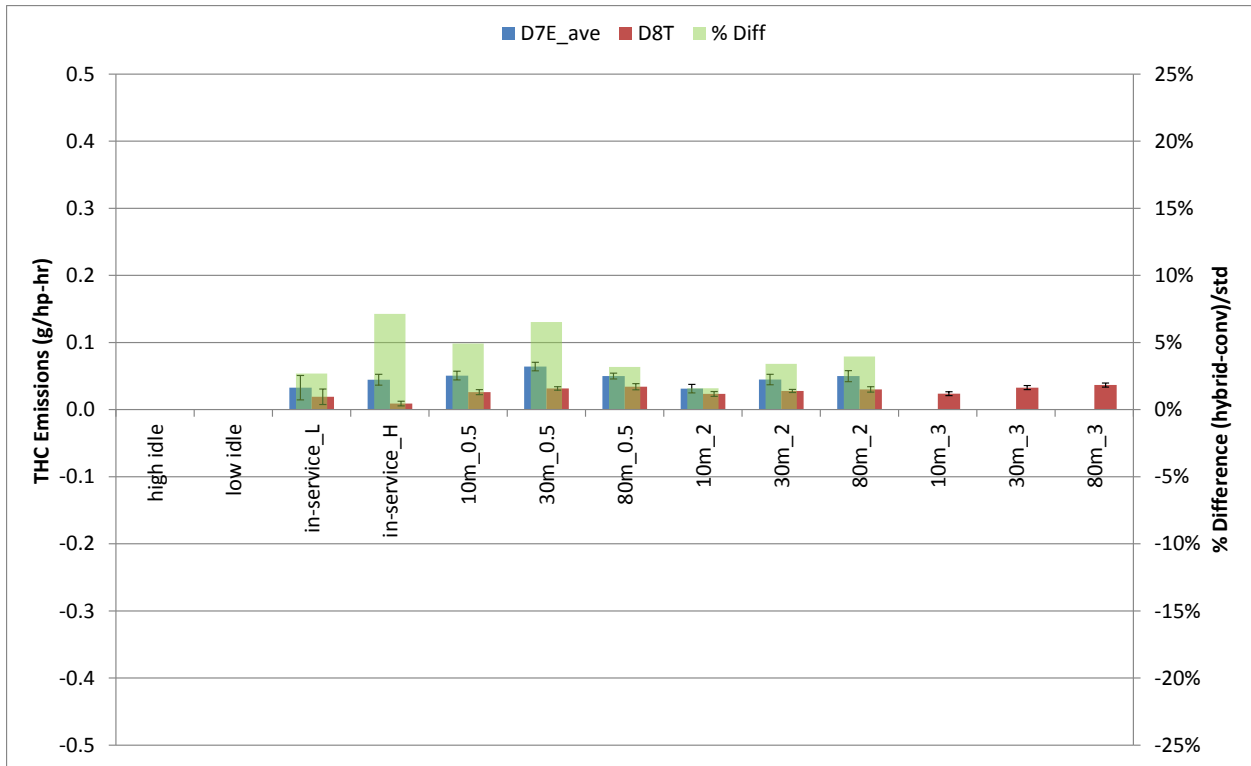


### 2.1.2 Brake Specific Emission (g/hp-hr)

For brake specific emissions, the D7E general showed a benefit except for in-service NO<sub>x</sub>.







### 3 D7E-T4i vs D8R-T2 Supplementary Results

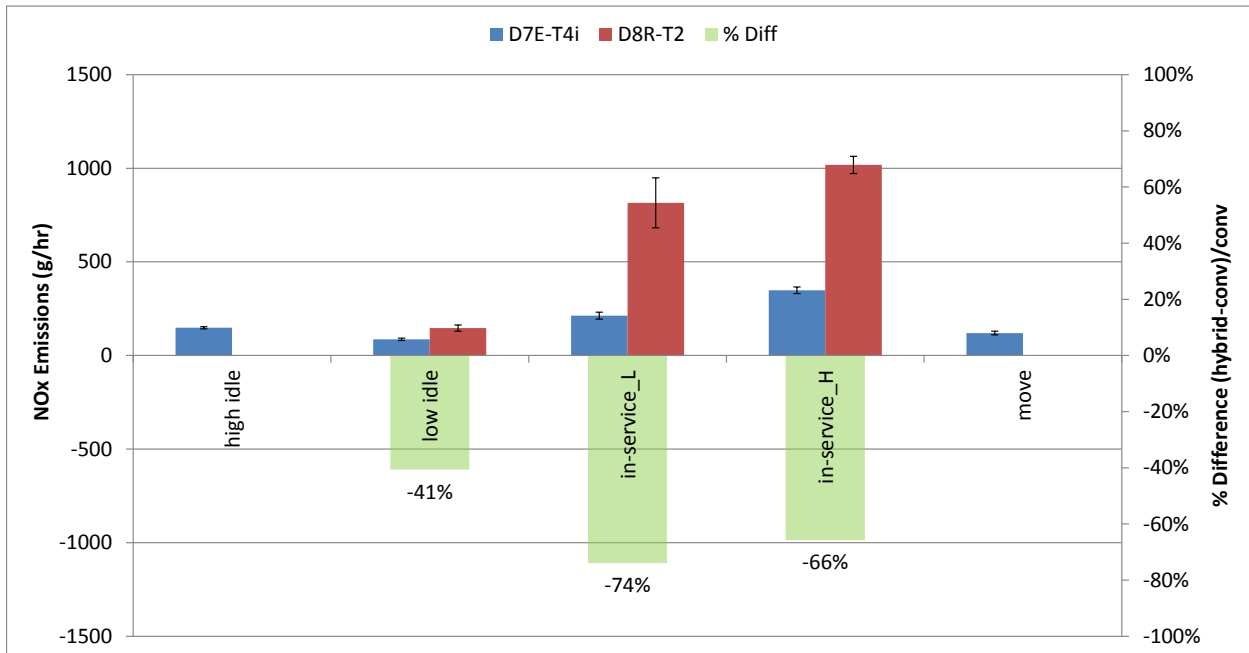
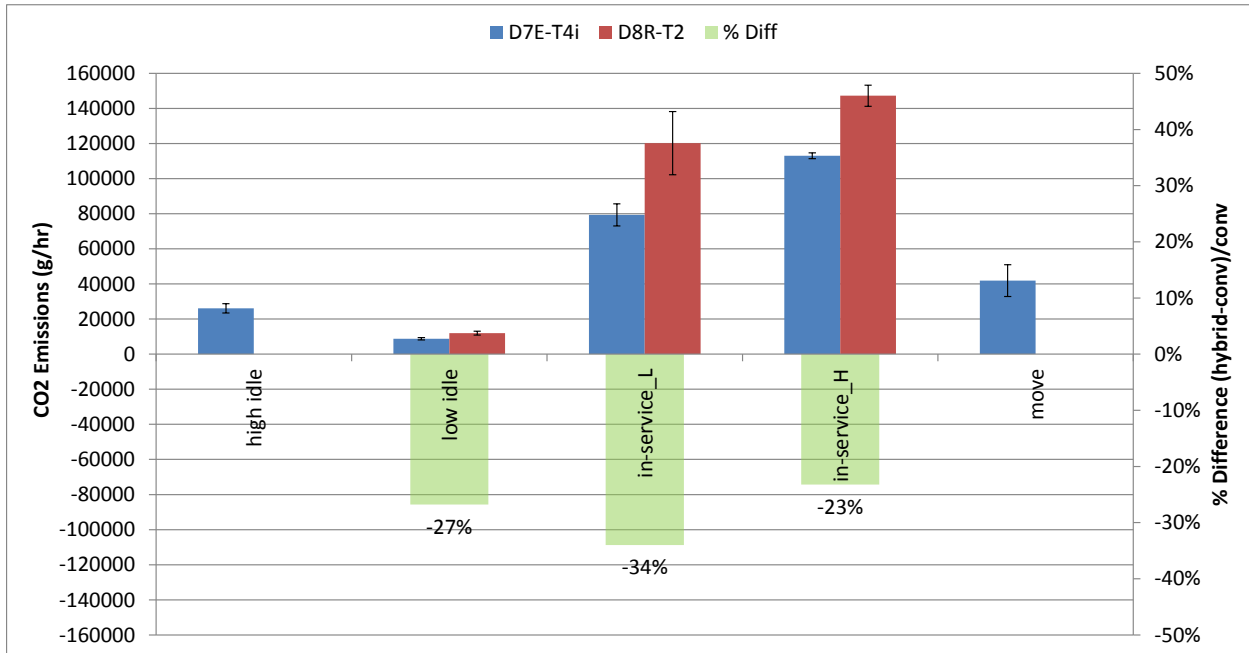
#### 3.1 In revenue service test

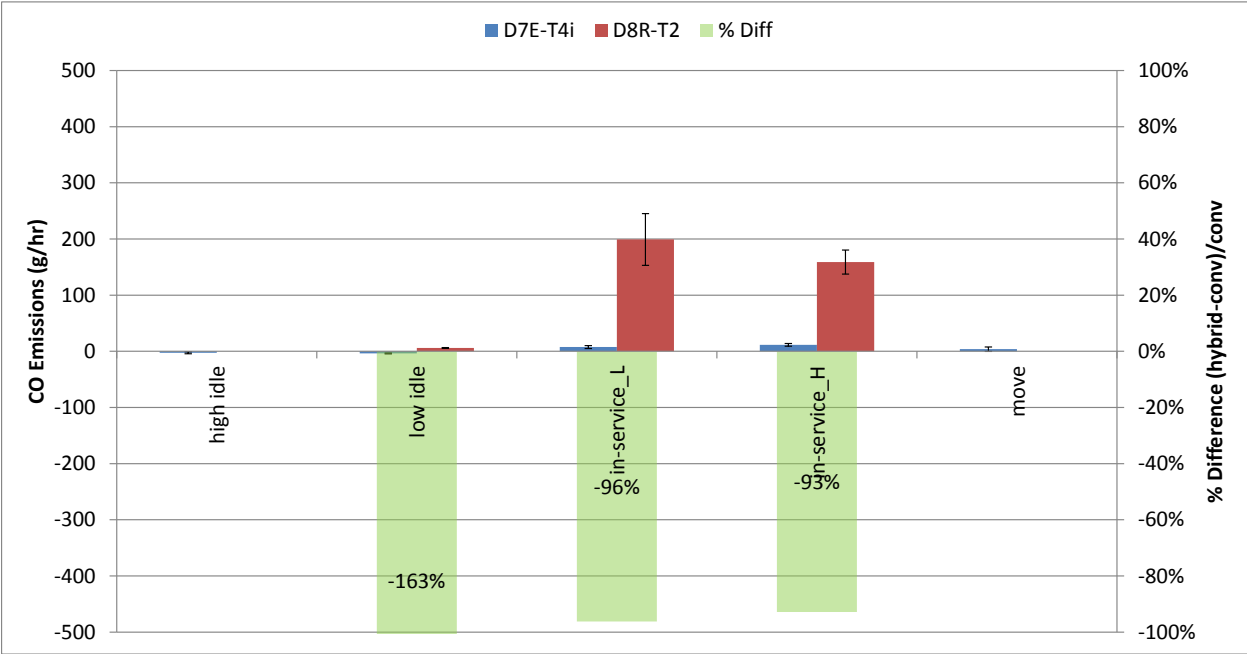
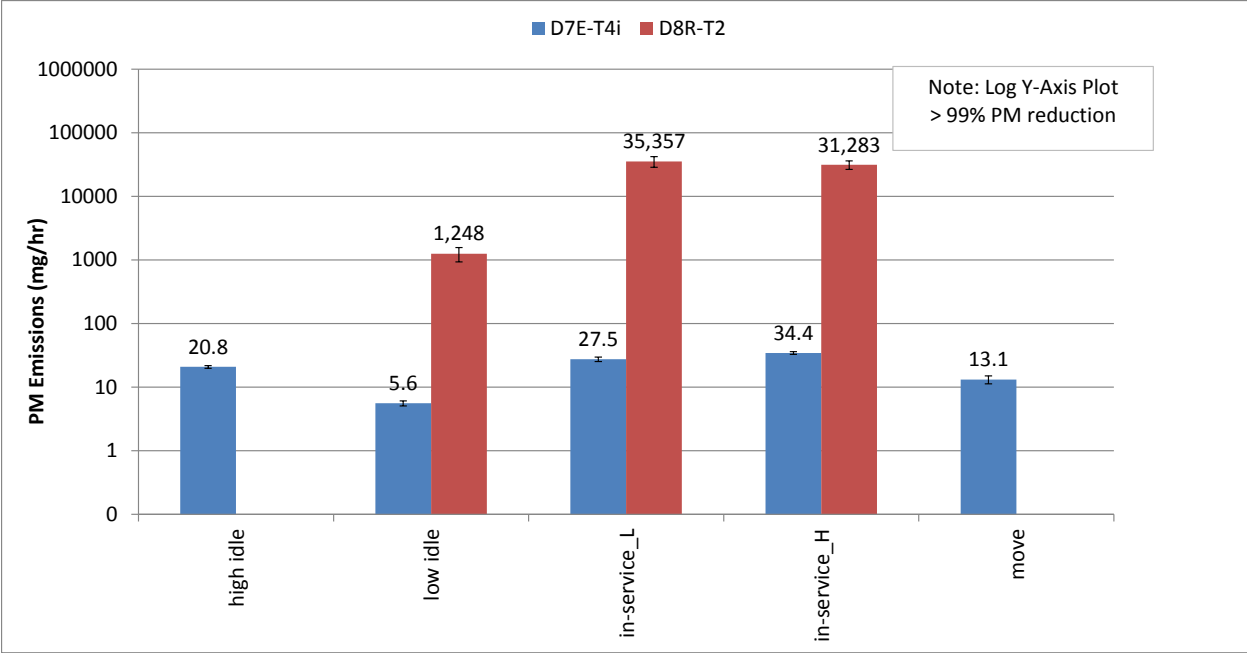


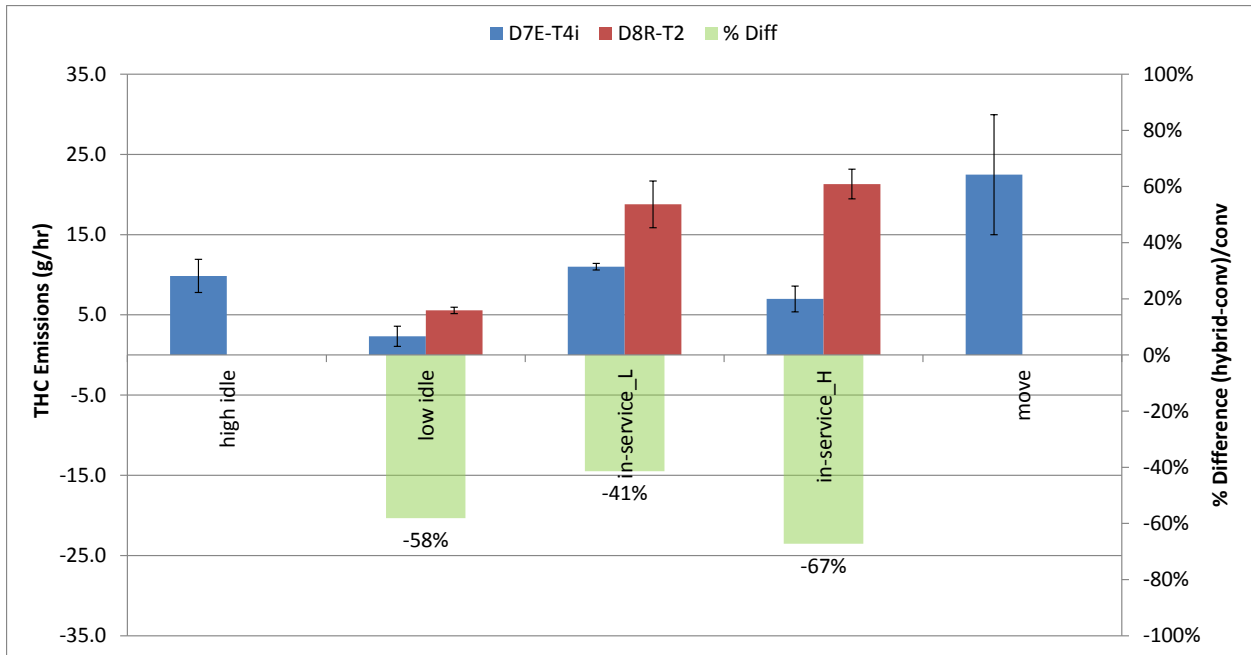
For the comparison between the D7E and the D8R, only in revenue service test was performed. Each unit was tested for one work day where the unit is assign to its daily duty at the landfill. The purpose of this comparison is to see the fuel economy comparisons between the two units. No materials were measured and the comparison between NO<sub>x</sub>, CO, THC, and PM emissions is not valid due to tier level differences.

### 3.1.1 Time Specific Emission (g/hr)

The D8R showed higher time specific <sub>2</sub> emission since it's a larger machine than the D7E and lower tier level. There is around 40% to 70% reduction in NO<sub>x</sub>, and close to 100% reduction in CO, THC, and PM due to tier level/after treatment system.

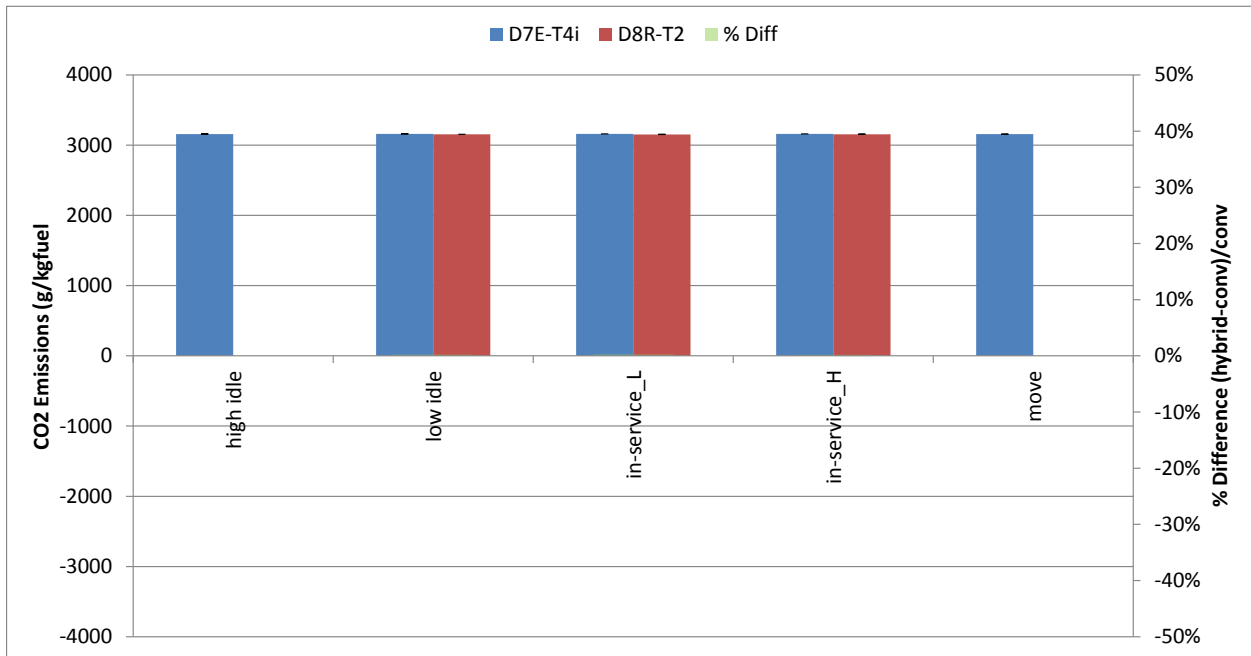


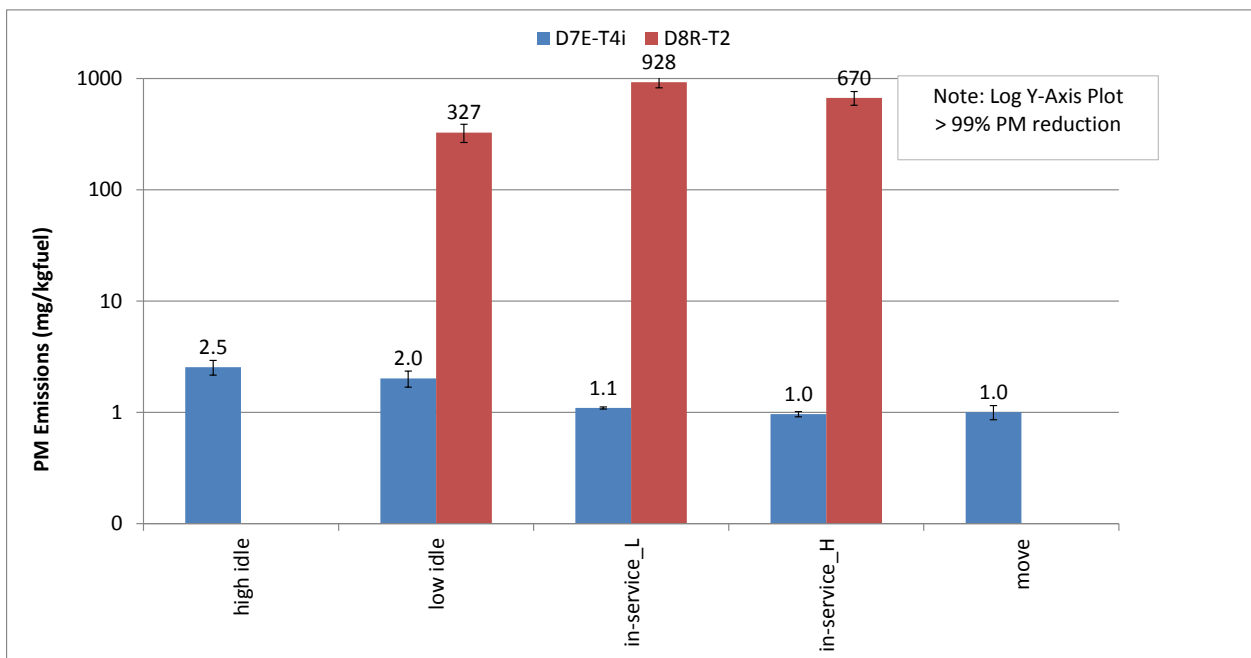
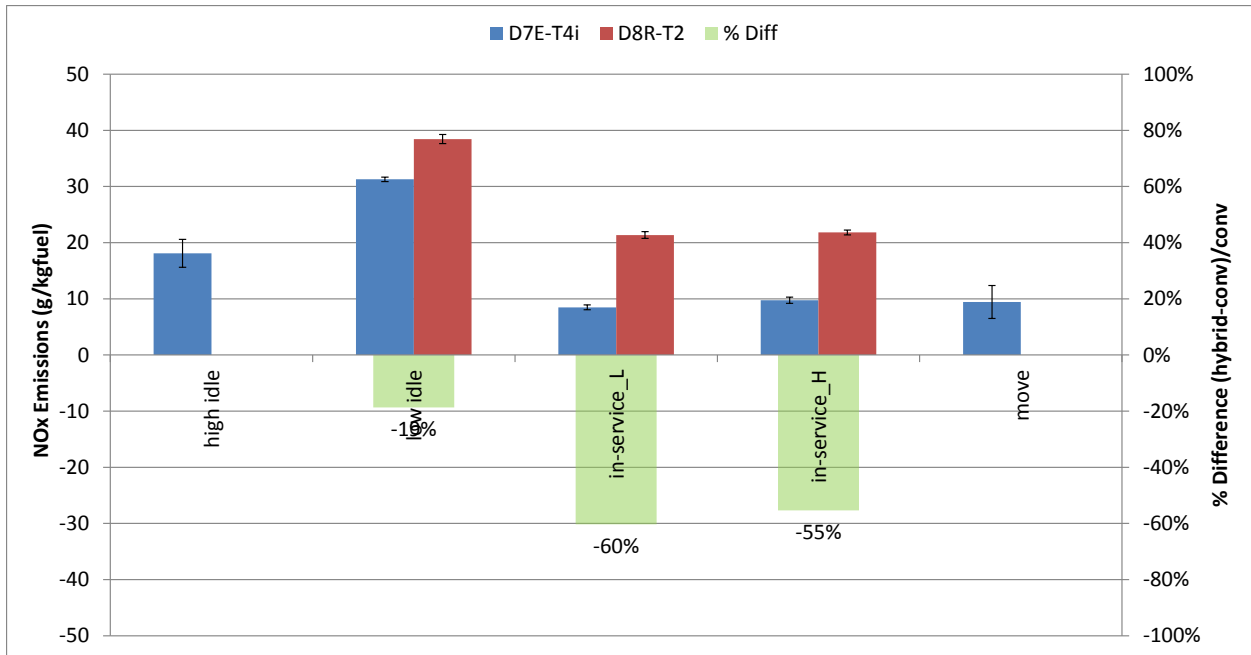


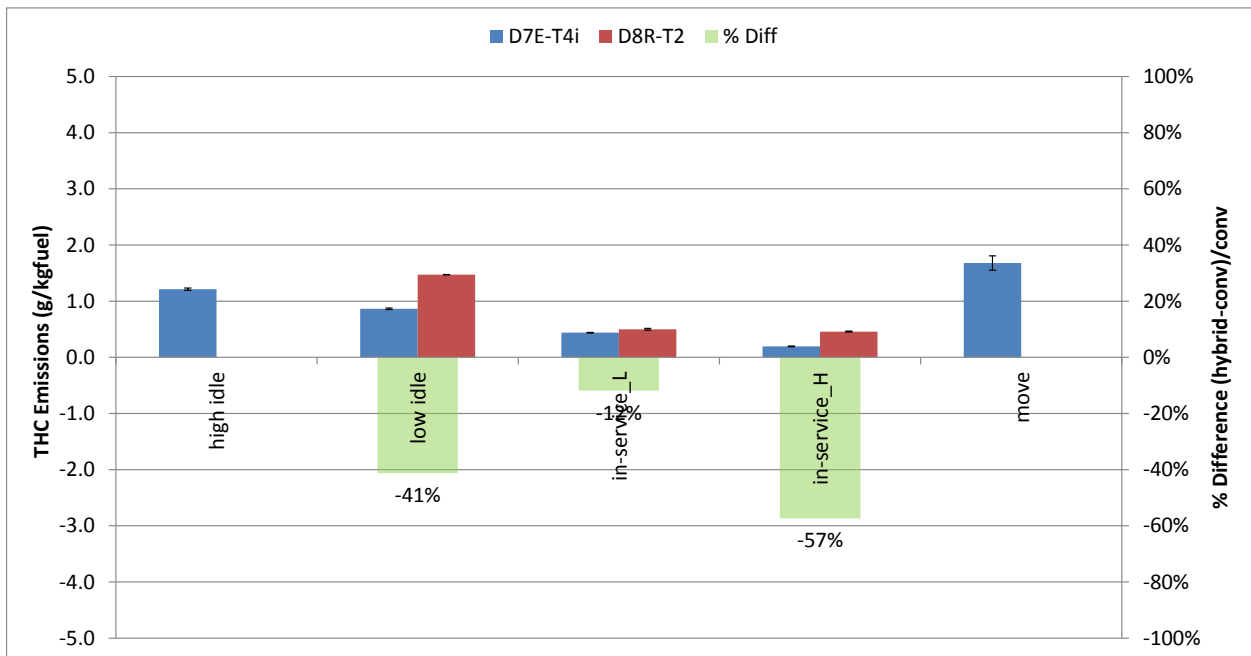
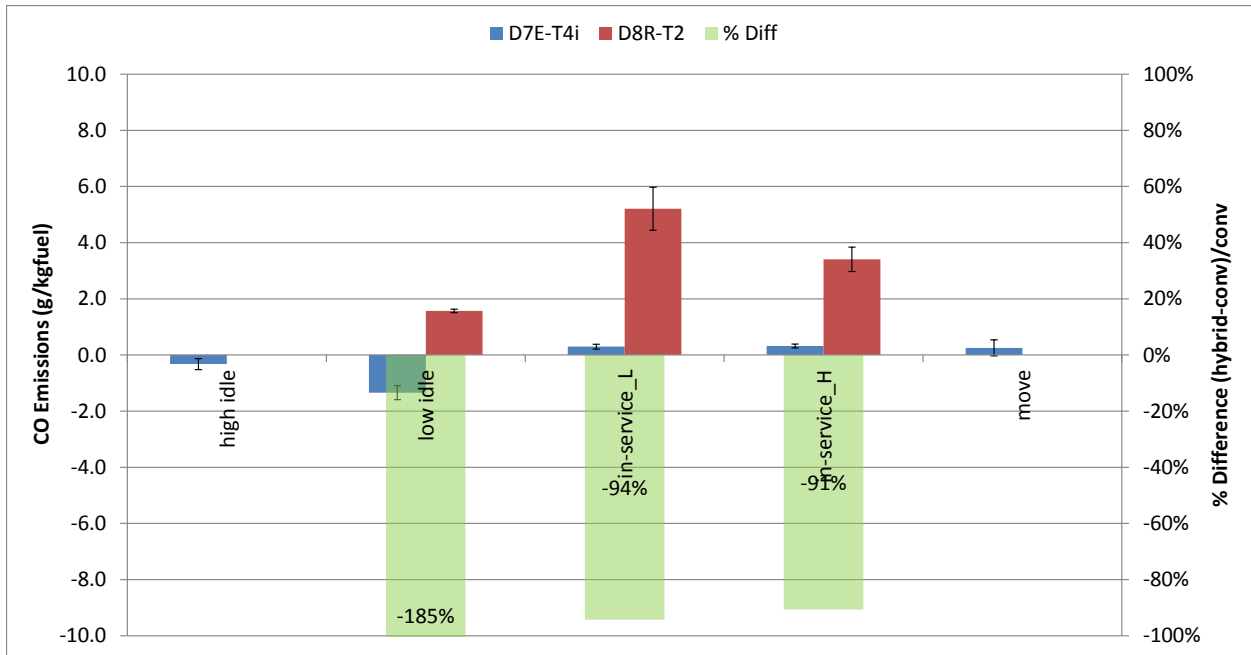


### 3.1.2 Fuel Specific Emission (g/kgfuel)

Fuel specific emissions showed the same trend. Again, the reduction is mostly due to difference in tier level.

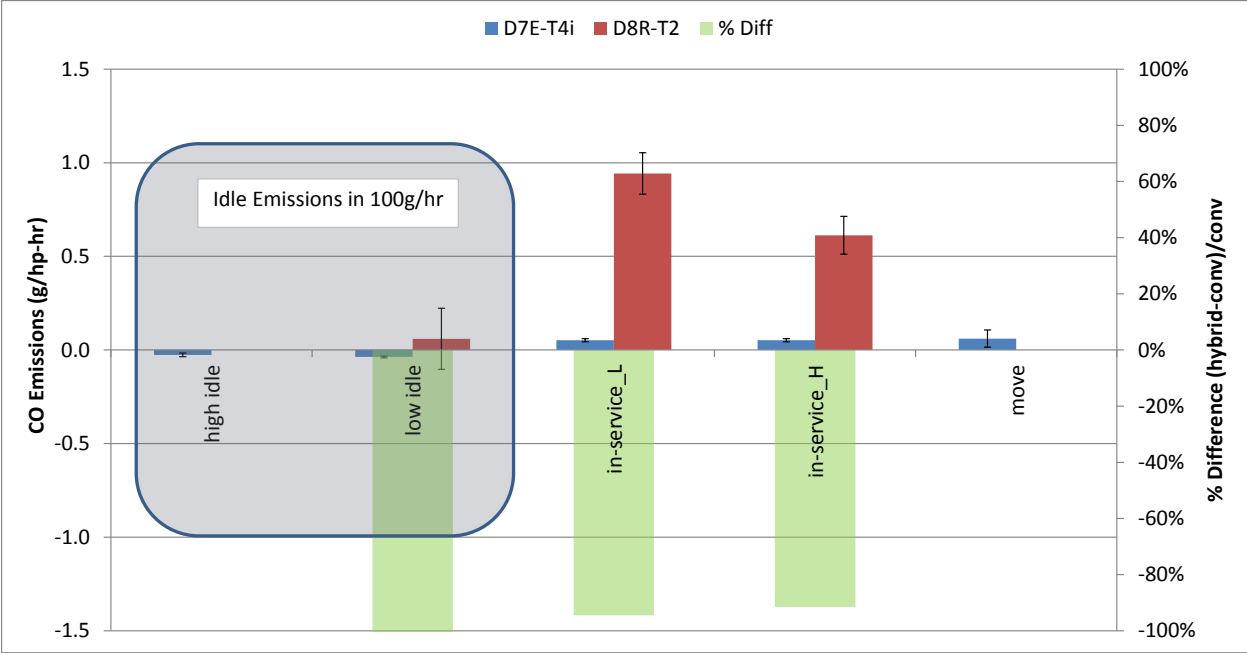






### 3.1.3 Brake Specific Emission (g/hp-hr)

CO and THC brake specific emission are shown in this section. Large reduction in emission is due to newer engine and after treatment technologies.



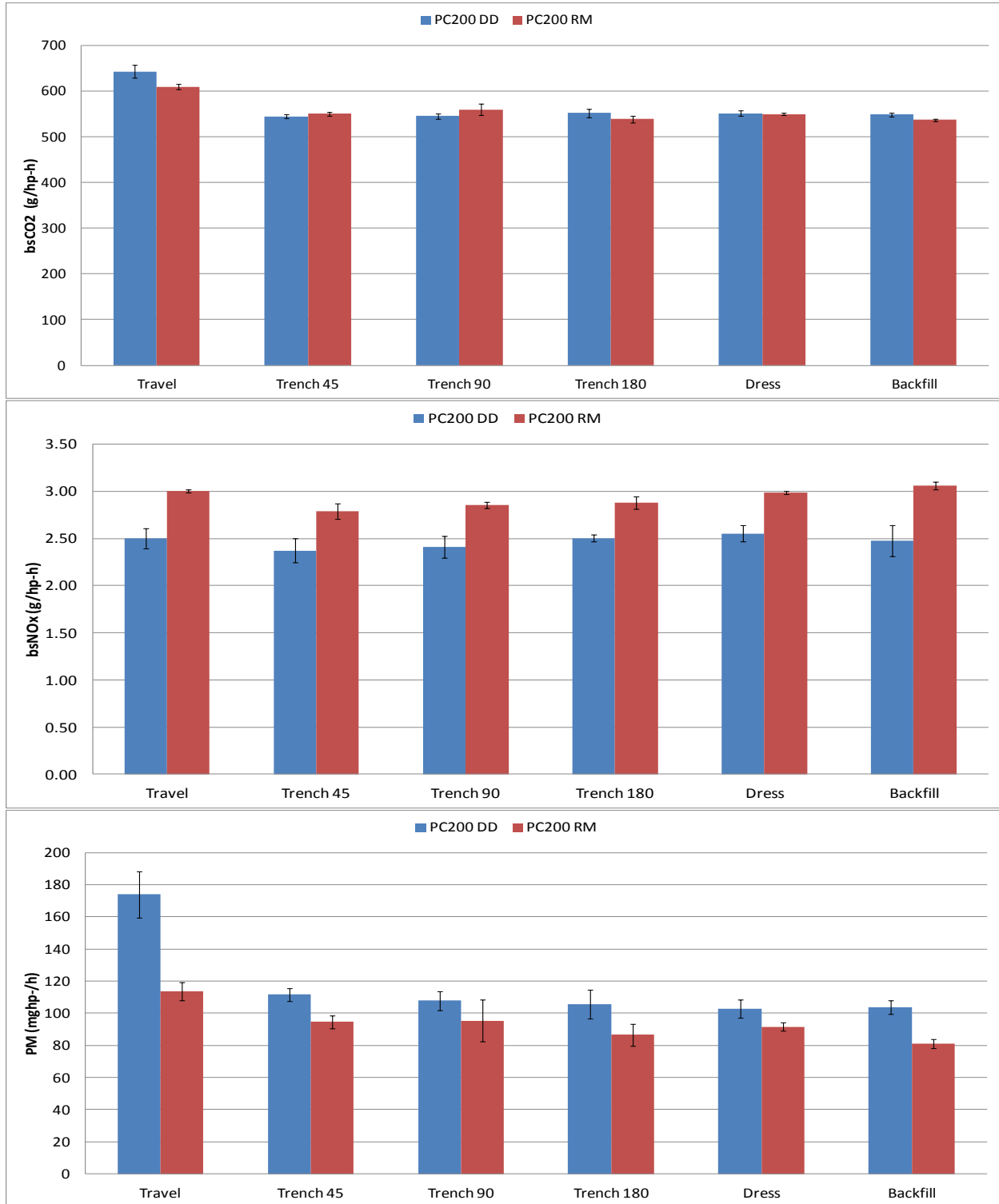
## **Appendix J. Supplementary Emissions Excavator**

In this appendix we present the modal emissions results for each model of excavator on a brake-specific and a fuel-specific basis. The results were already presented in the body of the report on time-specific basis.

### **4 PC200 Excavators**

### 4.1 Brake specific results

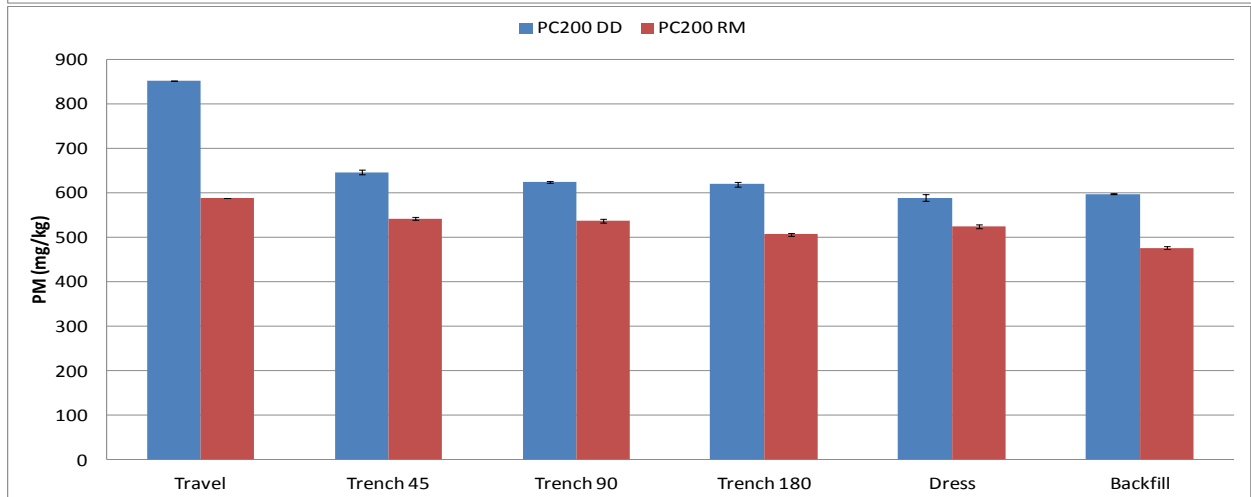
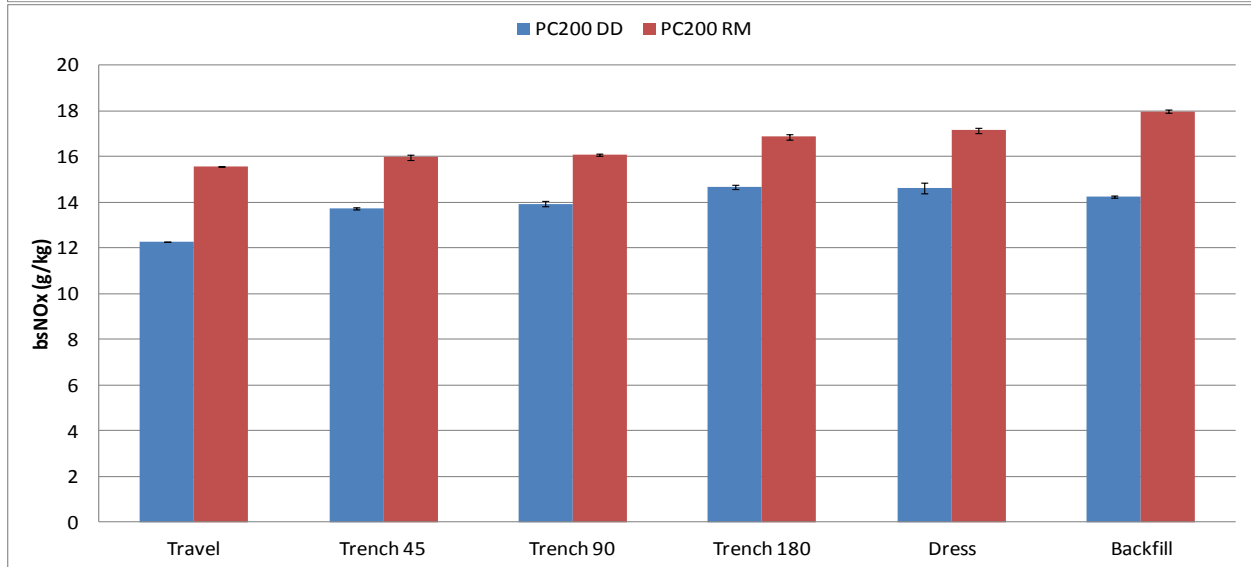
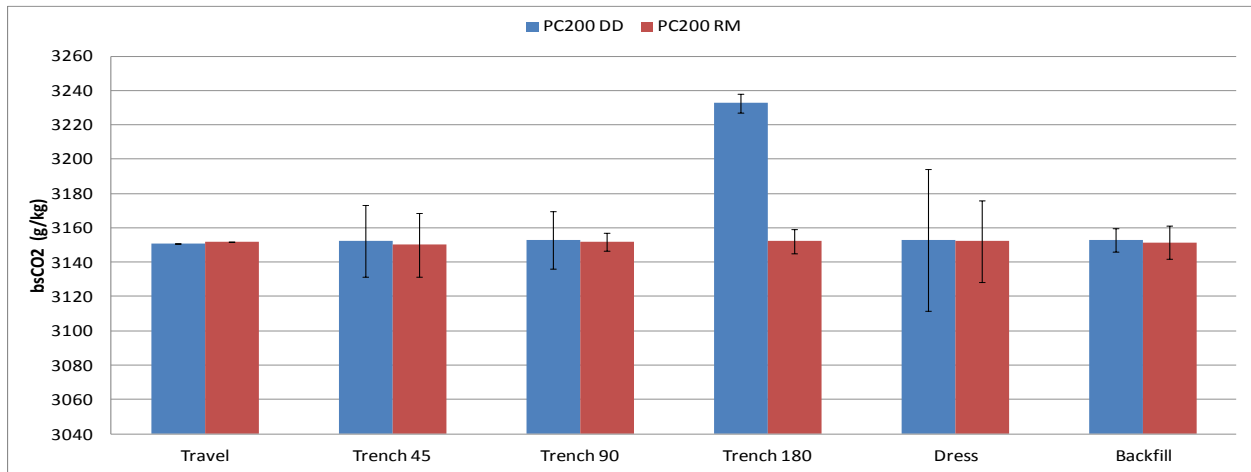
The following three column plots show results for CO<sub>2</sub>, NO<sub>x</sub>, and PM on a brakework-specific basis. The means are for triplicate measurements. The error bars are one standard deviation of the underlying data.





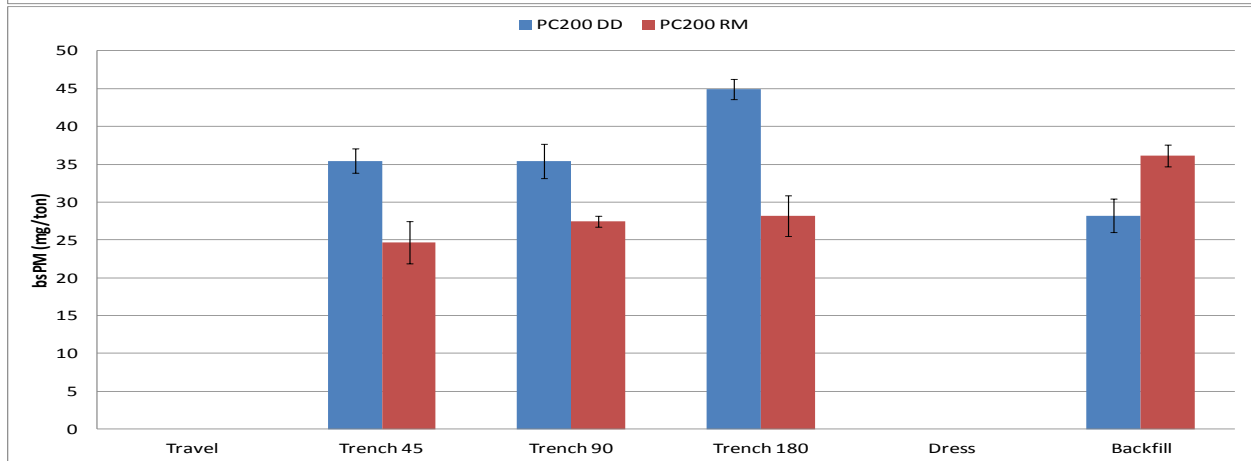
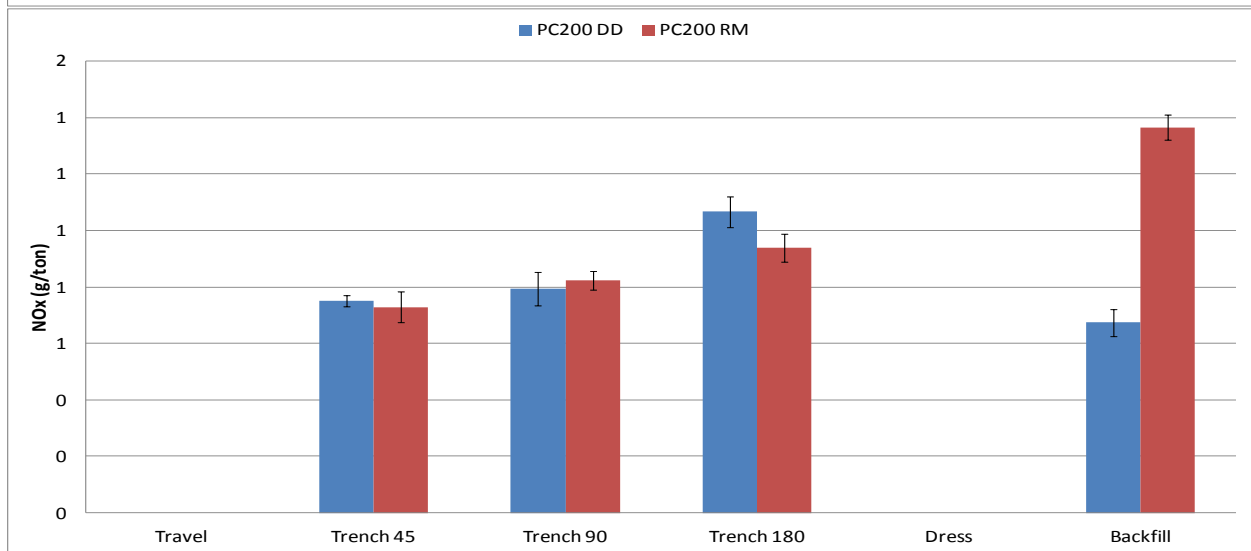
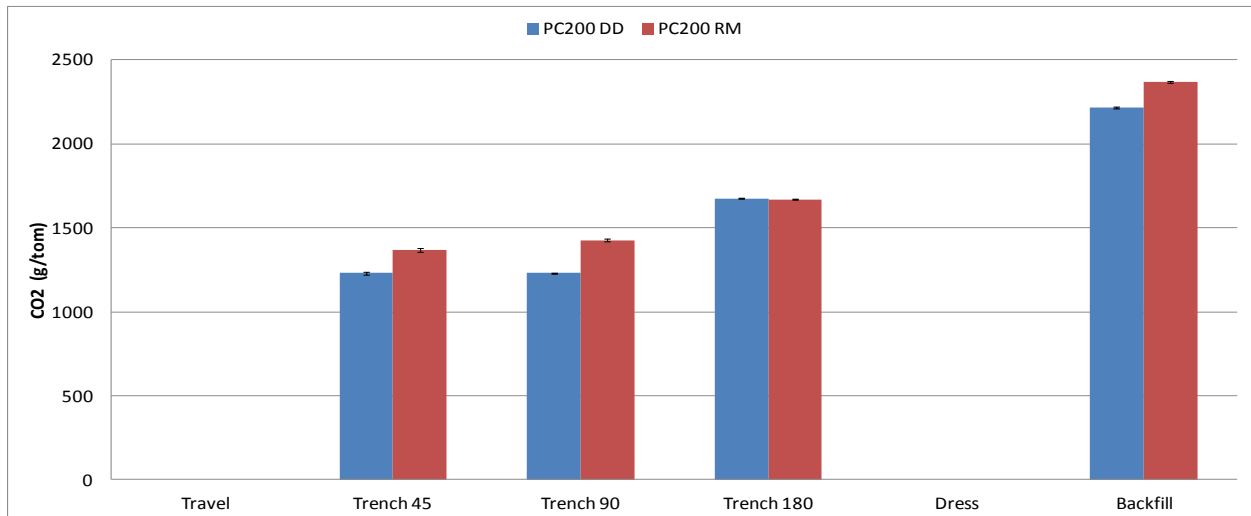
## **4.2 Fuel-specific results**

The following three column plots show results for CO<sub>2</sub>, NO<sub>x</sub>, and PM on a fuel-specific basis. The means are for triplicate measurements. The error bars are one standard deviation of the underlying data.



### **4.3 Material-specific results**

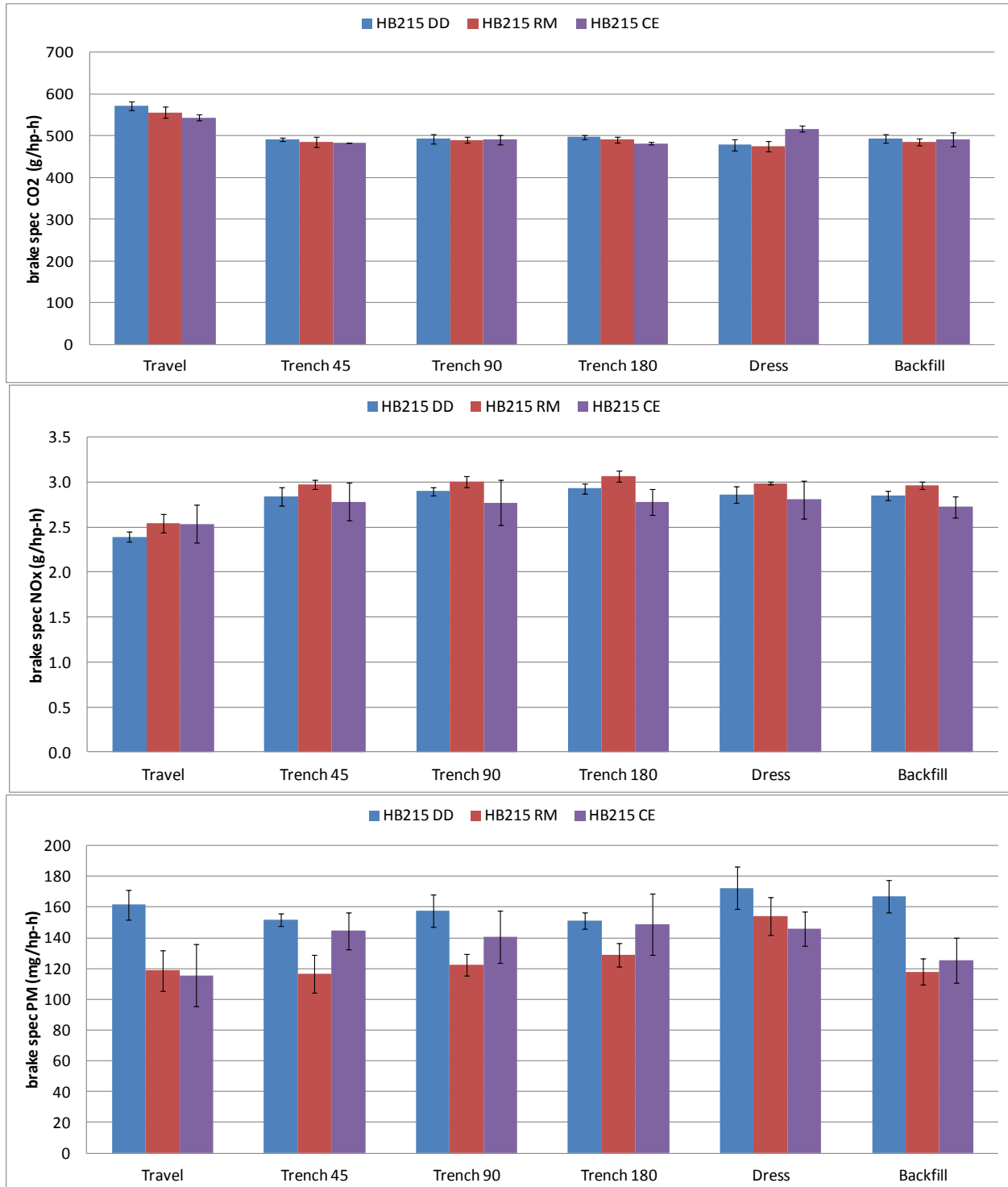
The following three column plots show results for CO<sub>2</sub>, NO<sub>x</sub>, and PM on a material-specific basis. The means are for triplicate measurements. The error bars are one standard deviation of the underlying data.



## 5 HB215 Excavators

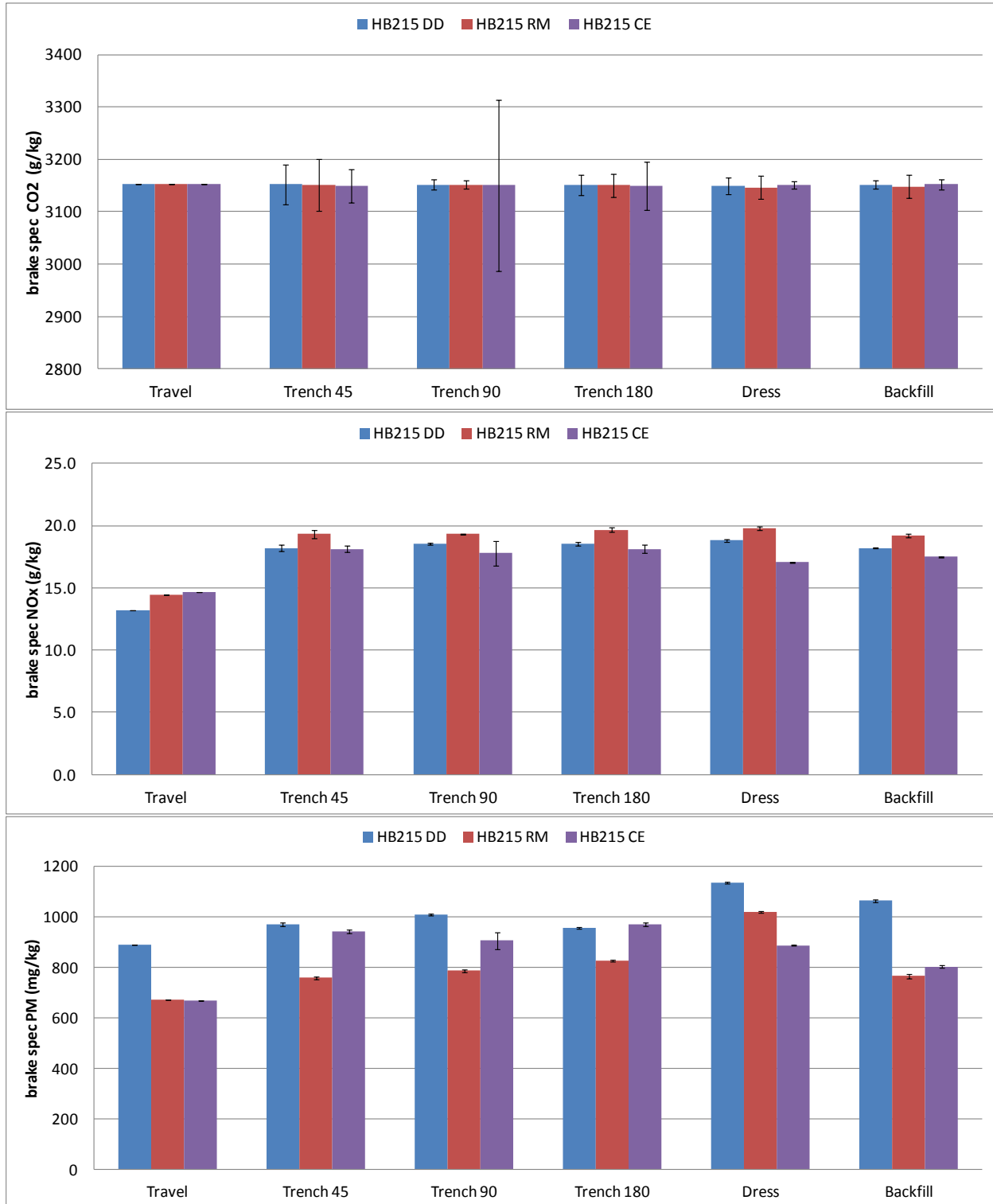
### 5.1 Brake specific results – HB215

The following three column plots show results for CO<sub>2</sub>, NO<sub>x</sub>, and PM on a brakework-specific basis. The means are for triplicate measurements. The error bars are one standard deviation of the underlying data.



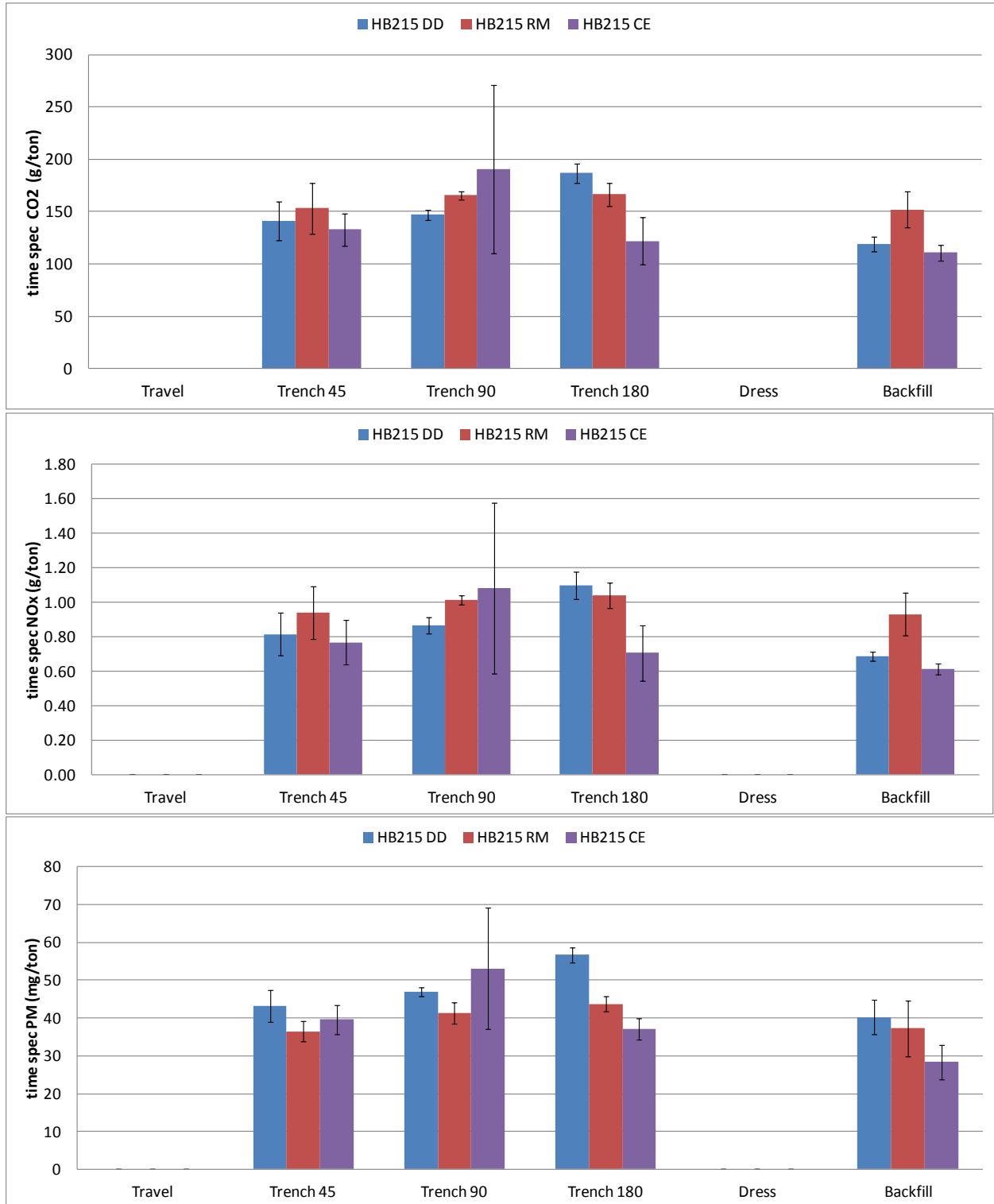
## 5.2 Fuel-specific results – HB215

The following three column plots show results for CO<sub>2</sub>, NO<sub>x</sub>, and PM on a fuel-specific basis. The means are for triplicate measurements. The error bars are one standard deviation of the underlying data.



### 5.3 Material-specific results – HB215

The following three column plots show results for CO<sub>2</sub>, NO<sub>x</sub>, and PM on a material-specific basis. The means are for triplicate measurements. The error bars are one standard deviation of the underlying data.

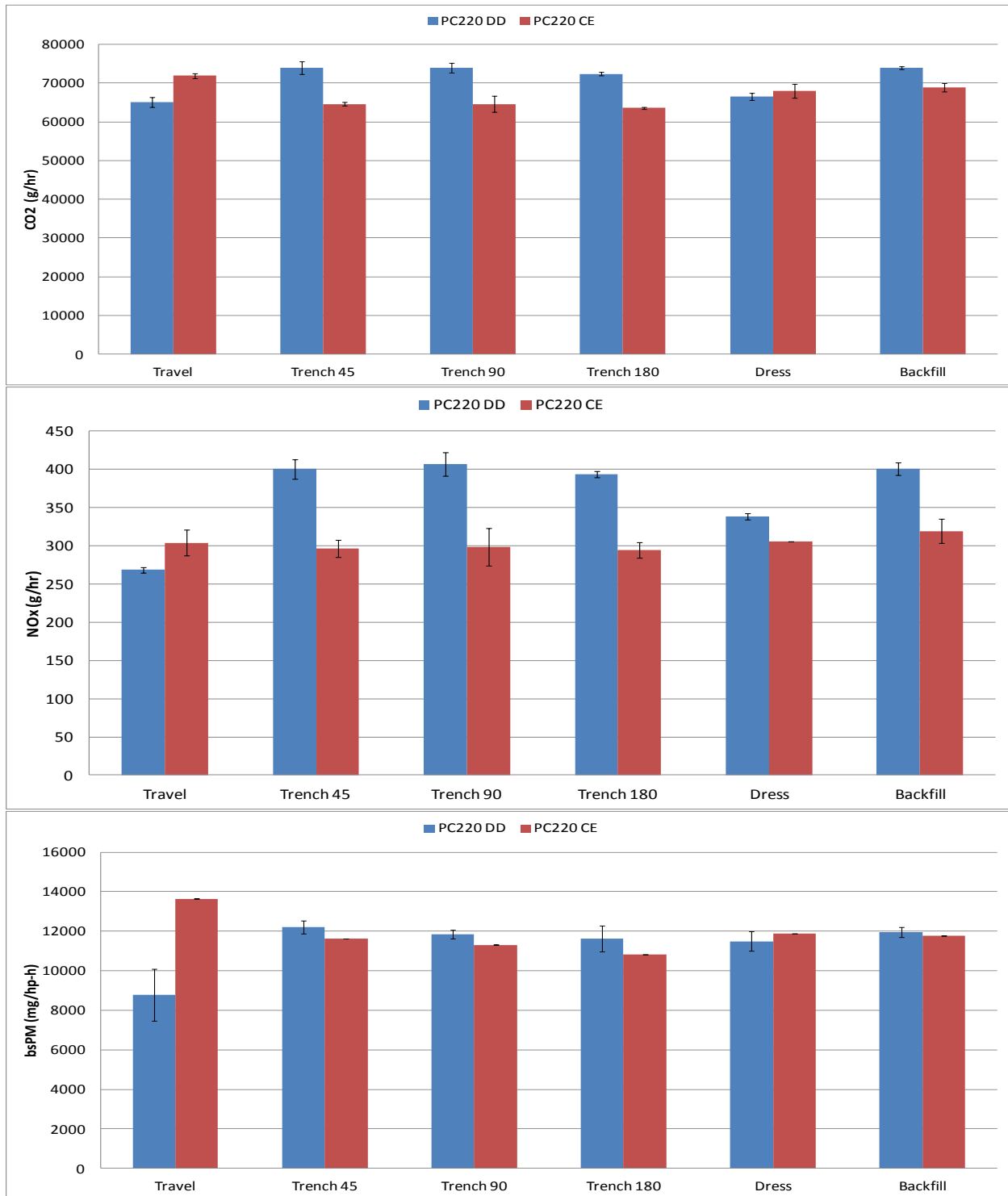


## **6 PC220 Excavators**

### **6.1 Brake specific results**

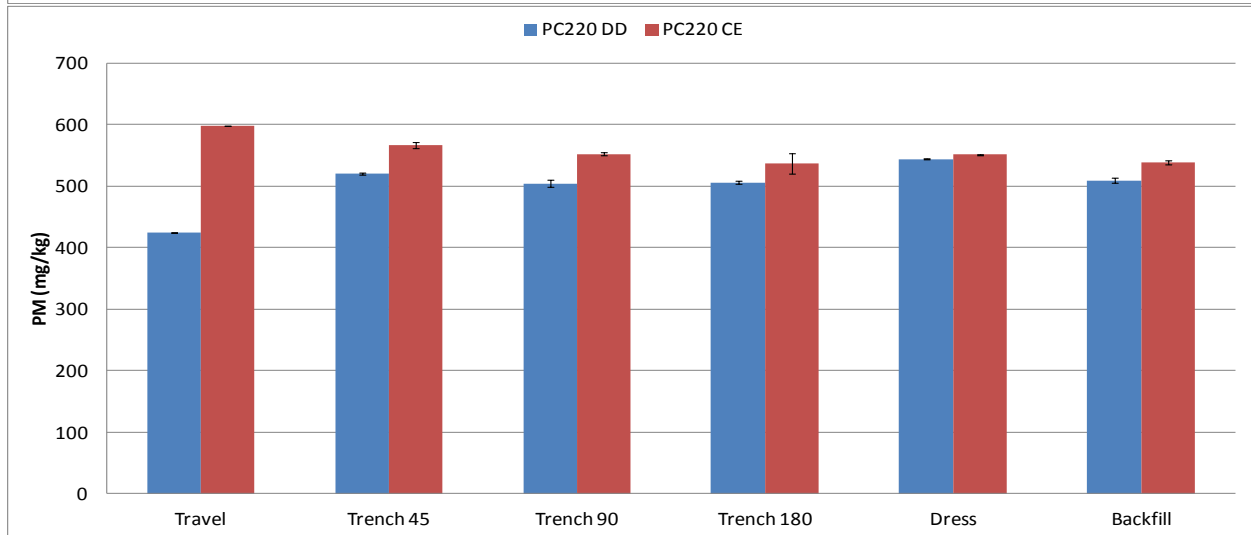
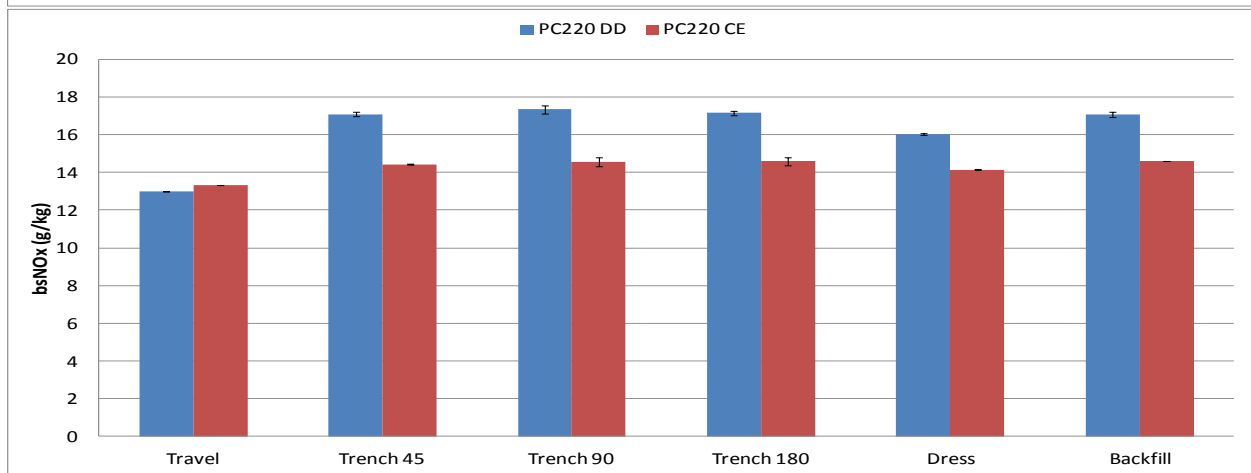
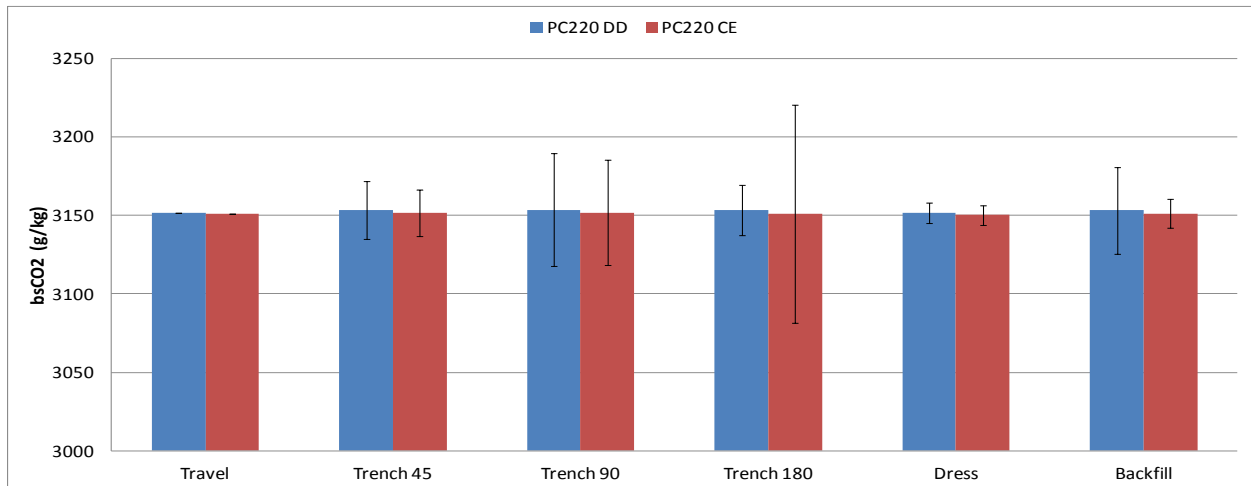
The following three column plots show results for CO<sub>2</sub>, NO<sub>x</sub>, and PM on a brakework-specific basis. The means are for triplicate measurements. The error bars are one standard deviation of the underlying data.





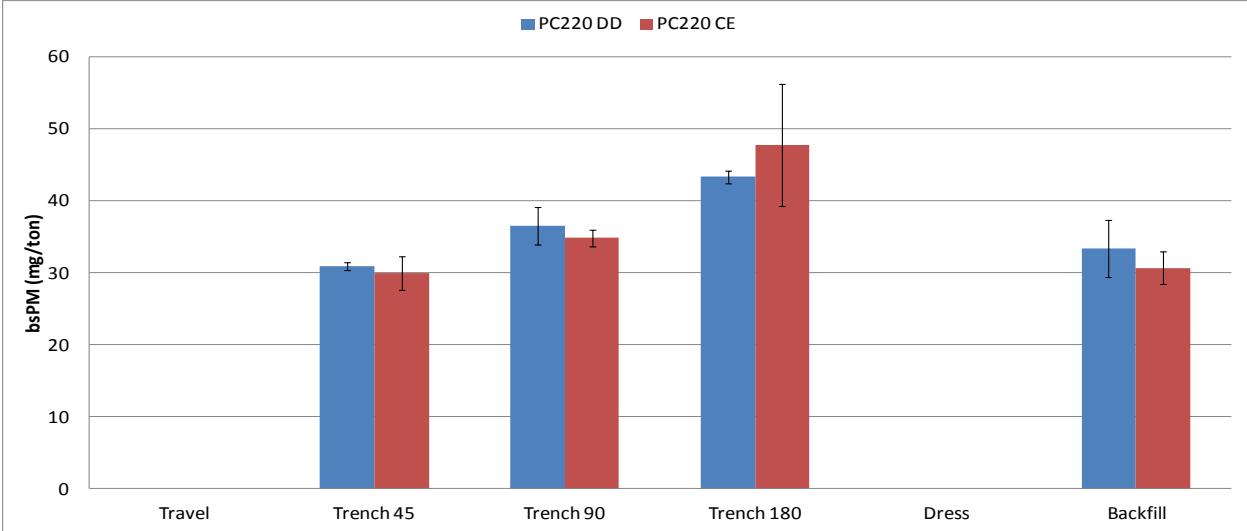
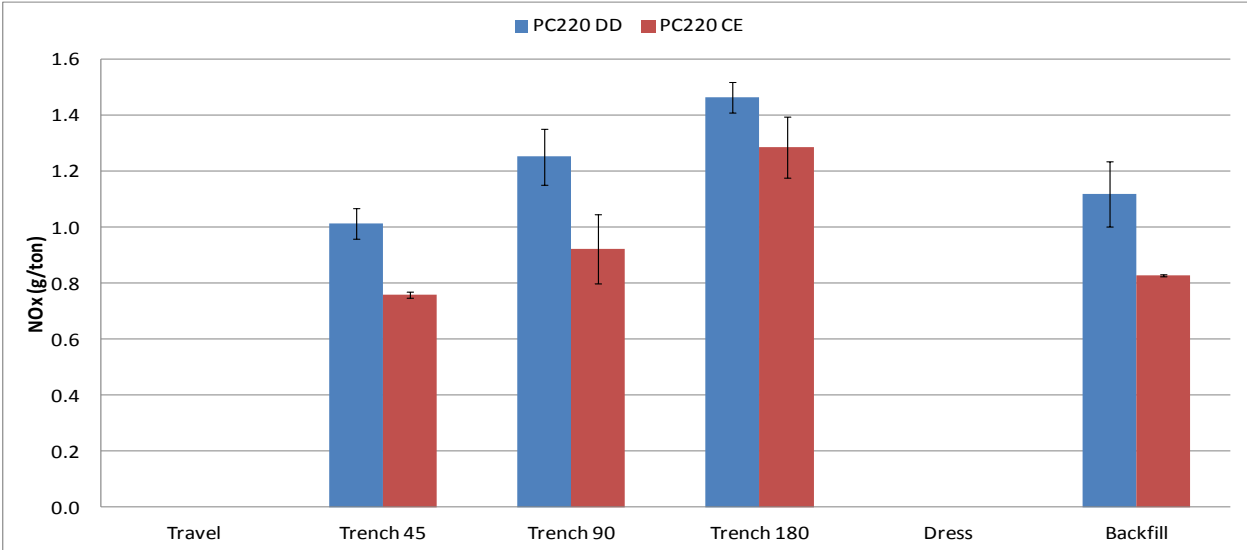
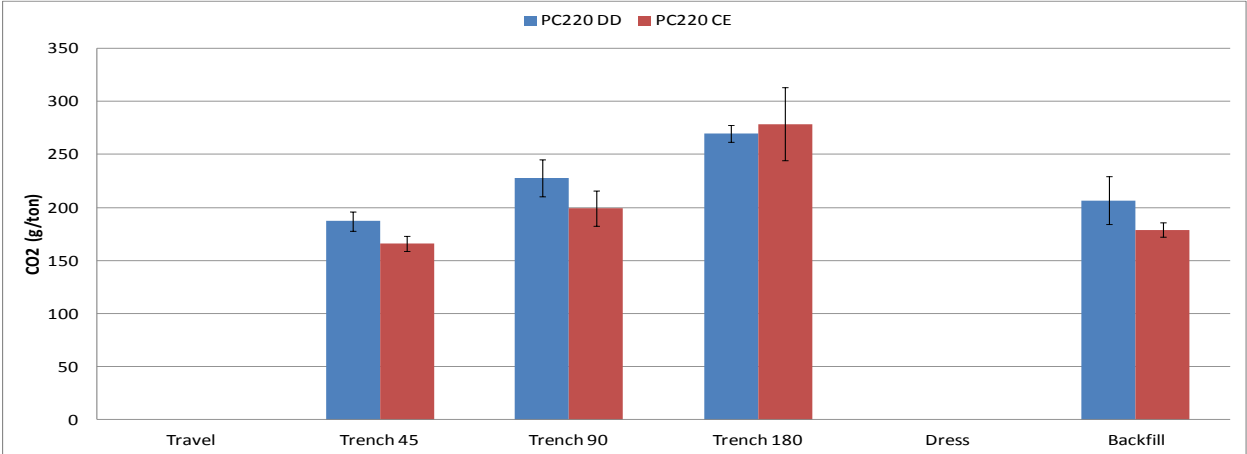
## 6.2 Fuel-specific results

The following three column plots show results for CO<sub>2</sub>, NO<sub>x</sub>, and PM on a fuel-specific basis. The means are for triplicate measurements. The error bars are one standard deviation of the underlying data.



### **6.3 Material-specific results – PC220**

The following three column plots show results for CO<sub>2</sub>, NO<sub>x</sub>, and PM on a material-specific basis. The means are for triplicate measurements. The error bars are one standard deviation of the underlying data.



## **Appendix K. Engine Lug curves**

To calculate in-use power and torque in off-road engines, one of more reliable way is to use to an OEM published engine lug curve. This method also requires engine speed and percent load for the vehicle ECM.

For off-road engines, vehicle ECM was not available until recently MYs. The availability varies from one manufacture to another. Companies like John Deere, Caterpillar adopted ECM slightly ahead of others. Some newer/smaller manufactures still do not have ECM for equipment up to date. At the same time, there are still no rules or regulations written for off-road engines to provide ECM information. This adds another level of difficulty for researchers who want to study the in-use emissions from off-road equipment.

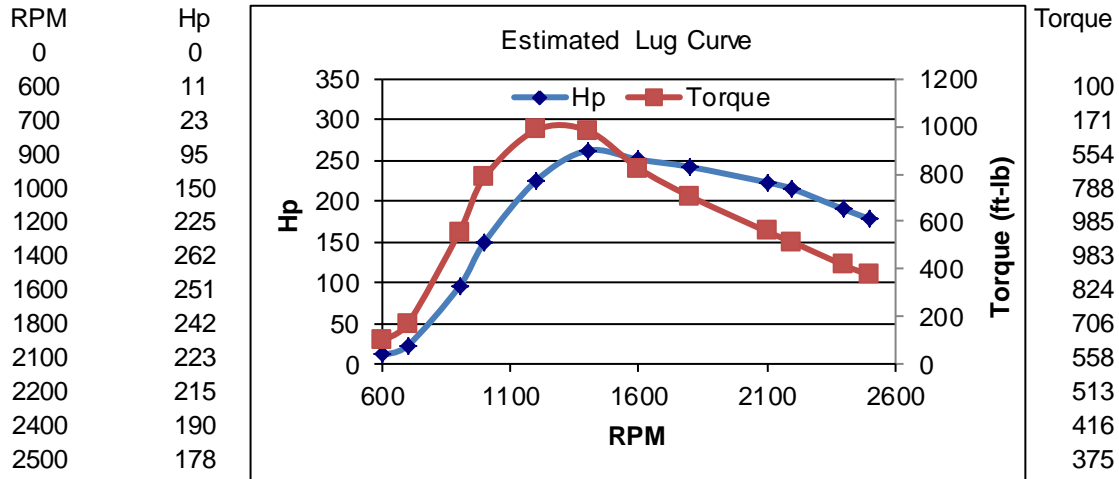
UCR experienced some major difficulties with test unit's ECM at the beginning of this program. Majority of our test units were MY 2011 or newer, those engine did have ECM available. However, most of the ECM information was proprietary and not accessible unless use OEM supplied diagnostic tools. UCR worked with CSM and developed a program using CSM's UniCAN ECM data logger and able to obtain most of the interested information including engine speed and percent load.

### **Engine Lug Curve for Caterpillar Bulldozers**

UCR encountered some major difficulties while trying to obtain the engine lug curve for the Caterpillar bulldozers. The older conventional unit, D8R, was obtained from our contact at the local CAT dealer early on from another program. For the newer bulldozers, none of the request was successful from the local dealer. We forwarded request to our contact at Caterpillar, UCR still have not received a reply up to date of this report.

While there is not official lug curve available, in order to calculate real time power and torque, UCR employed a method to estimate a lug curve based on published information. The Caterpillar OEM ECM tool *Caterpillar Electronic Technician* provides "Rated Power" and "Rated Peak Torque" information from each ECM. The power and peak torque provide two accurate points on the engine lug curve. Moreover, the equipment product brochure often provides one more rate power point that we can use to estimate a lug curve. The rest of the points on the lug curve are estimated based on best engineering judgment also cross checked with brake specific CO<sub>2</sub>.

### Engine Lug Curve for 2012 Caterpillar D6T (Estimated)



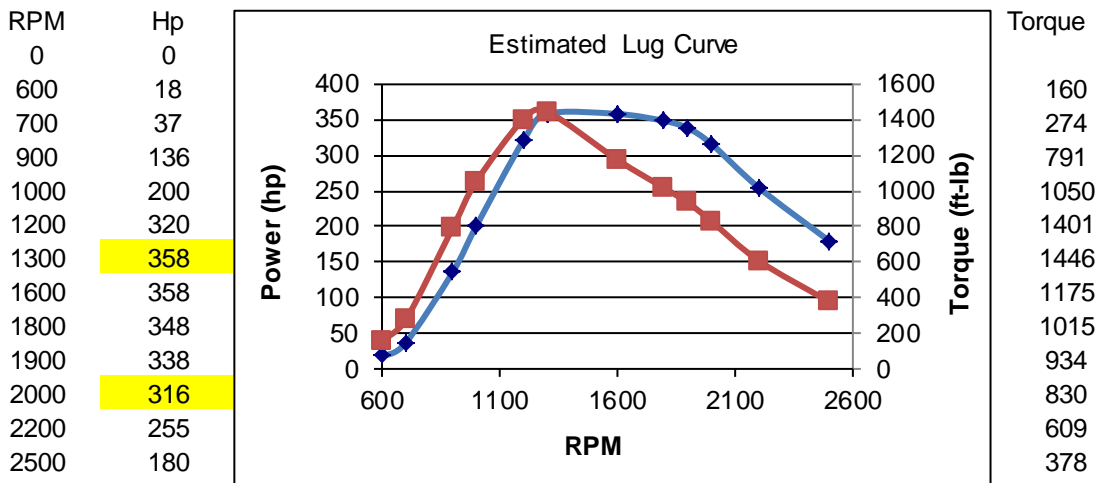
<sup>1</sup> real time data is interpolated from this lug curve using a linear regression between RPMs

<sup>2</sup> colored data is estimated due to limitations of provided lug curves

	Hp	RPM	ft-lb
Peak Torque <sup>1</sup>	253	1300	1021
Rated Hp <sup>1</sup>	223	2000	586

<sup>1</sup> Taken from CAT ET ECM serial number 21726017QM for D6T

### Engine Lug Curve for 2012 Caterpillar D8T (Estimated)



<sup>1</sup> real time data is interpolated from this lug curve using a linear regression between RPMs

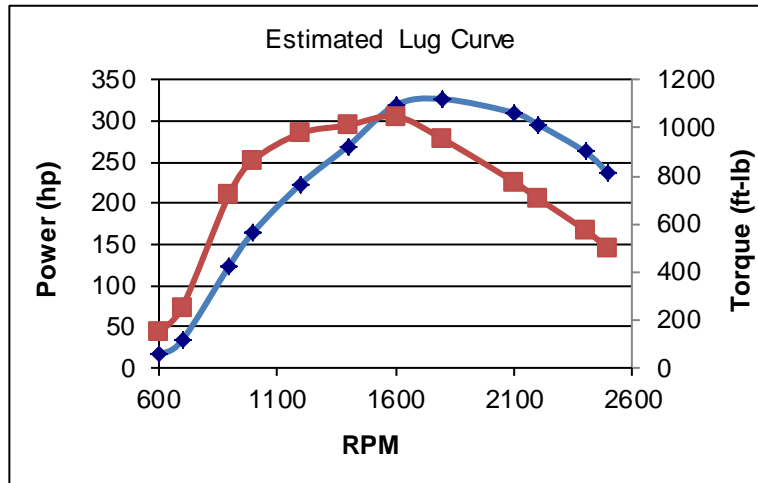
<sup>2</sup> colored data is estimated due to limitations of provided lug curves

	Hp	RPM	ft-lb
Max <sup>1</sup>	358	1300	1446
Rated <sup>1</sup>	316	2000	830

<sup>1</sup> Taken from CAT ET ECM download (SN TXL02842)

### Engine Lug Curve for 2011 Caterpillar D7E (Estimated)

RPM	Hp
0	0
600	17
700	33
900	124
1000	165
1200	223
1400	269
1600	319
1800	327
2100	310
2200	296
2400	262
2500	236



Torque
147
251
725
865
977
1011
1047
953
775
706
574
496

<sup>1</sup> real time data is interpolated from this lug curve using a linear regression between RPMs

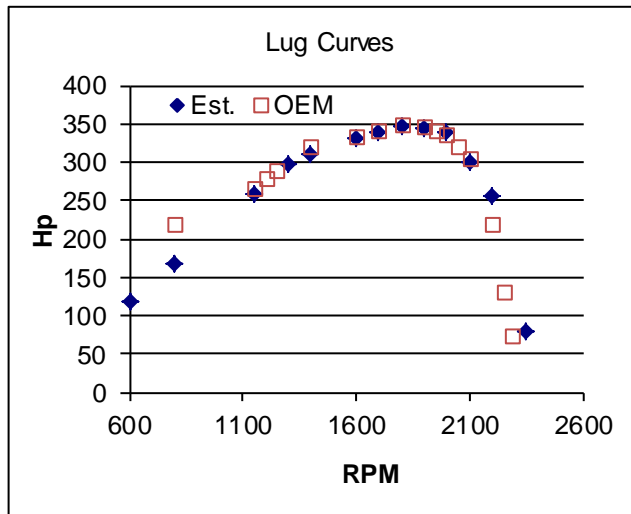
<sup>2</sup> colored data is estimated due to limitations of provided lug curves

	Hp	RPM	ft-lb
Max <sup>1</sup>	328	1600	1047
Rated <sup>1</sup>	296	2200	707

<sup>1</sup> Taken from CAT ET ECM download (SN MME02375) from WM D7E bulldozer

### Engine Lug Curve for 2003 Caterpillar D8R (Published)

RPM	Hp
0	0
600	118
800	168
1150	259
1300	297
1400	310
1600	332
1700	338
1800	348
1900	345
2000	338
2100	300
2200	255
2350	80



Torque
1032.9
1102.9
1182.8
1199.9
1162.9
1089.8
1044.2
1015.4
953.7
887.6
750.3
608.8
178.8

<sup>1</sup> real time data is interpolated from this lug curve using a linear regression between RPMs

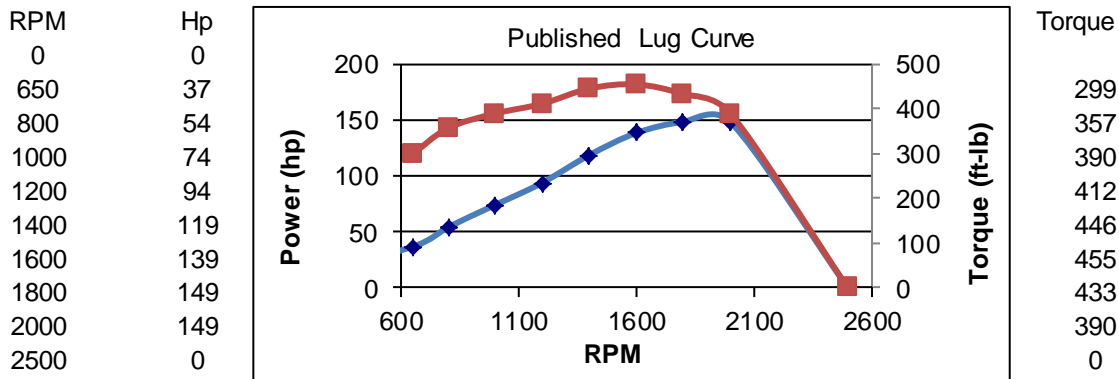
<sup>2</sup> colored data is estimated due to limitations of provided lug curves

Rated Hp	338	hp at 2000 rpm
Peak Hp	348	hp at 1800 rpm
Rated Torque	1200	ft-lb at 1300 rpm

## Engine Lug Curve for Komatsu Excavators

Obtaining the engine lug curve on the Komatsu unit was much easier. The local dealer contact was able to obtain all lug curves for engines were tested.

### Engine Lug Curve for 2011 Komatsu HB215 (Published)

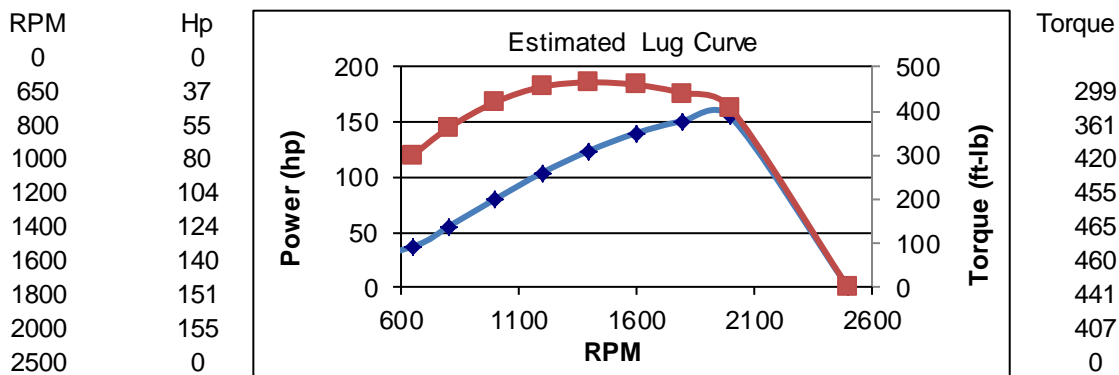


<sup>1</sup> real time data is interpolated from this lug curve using a linear regression between RPMs

	Hp	RPM	ft-lb	Nm
Peak Torque <sup>1</sup>	142	1700	438	594
Rated Hp <sup>1</sup>	148	2000	389	527

<sup>1</sup> Taken from official lug curve

### Engine Lug Curve for 2007&2010 Komatsu PC200 (Published)

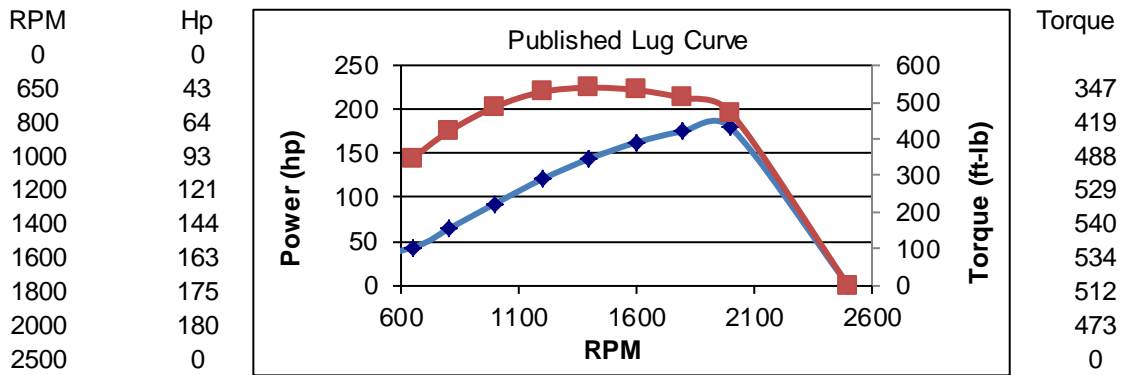


<sup>1</sup> real time data is interpolated from this lug curve using a linear regression between RPMs

	Hp	RPM	ft-lb	Nm
Peak Torque <sup>1</sup>	131	1500	460	624
Rated Hp	155	2000	407	552



### Engine Lug Curve for 2006 Komatsu PC220 (Published)



<sup>1</sup> real time data is interpolated from this lug curve using a linear regression between RPMs

	Hp	RPM	ft-lb
Peak Torque <sup>1</sup>	144	1400	540
Rated Hp <sup>1</sup>	180	2000	473

## **Appendix L. Overall Summary of Program**

The project deployment element provided funding for up to half the incremental cost of fully commercialized hybrid off-road equipment. The deployment effort successfully deployed equipment, provided cost comparisons, and customer feedback from hybrid fleet users. Additionally, some fleets were sufficiently satisfied with the performance of the hybrid equipment purchased through this program that they purchased additional units without financial assistance.

### *Deployment*

The program provided a total of \$901,578 voucher dollars towards the purchase of either hybrid and \$905,308 for the emissions and fuel economy testing of at least 6 bulldozers and 6 excavators, 3 hybrid and 3 conventional of each. The testing dollars include \$183,500 paid to the participants to offset disruptions in their normal operations while the testing was being conducted. Voucher dollars were used to reduce the purchase price of 16 hybrid pieces of construction equipment, ten Cat D7E bulldozers and six Komatsu HB215LC-1 excavators.

### *Activity*

To characterize the typical operation of different units, activity measurements were made on a subset of 6 hybrid and various comparable conventional construction equipment. Activity data were obtained using interviews, historical records, and in-use activity measurements that include time-lapse video, real-time engine control module (ECM) broadcast data, and real-time GPS data. The activity measurements were used to develop duty cycles and emissions weighting fractions that were representative and also repeatable in terms of getting realistic comparisons between the different equipment.

A subset of hybrid and conventional equipment were evaluated for emissions and fuel consumption over the developed duty cycles and in revenue service using a 1065 approved particulate matter (PM) and gaseous portable emissions measurement system (PEMS). The measurements were made for four different in-service fleets, two fleets for the bulldozer and two for the excavator.

### *Unit descriptions*

Two units were considered for this off-road hybrid evaluation project, the Caterpillar D7E bulldozer and the Komatsu HB215LC-1 excavator. See Figure ES-1 for the bulldozer and Figure ES-2 for the excavator. The excavator utilizes short-term energy storage and release as its upper structure turns and is thus considered a true hybrid. The bulldozer does not have energy storage and is thus considered a hybrid based on the fact that the diesel engine is a generator of electricity that powers the bulldozer. Thus, the bulldozer is a hybrid because it employs a diesel engine and electric motors.



**Figure ES-1 Hybrid D7E Caterpillar bulldozer evaluated**



**Figure ES-2 Hybrid HB215LC-1 Komatsu excavator evaluated**

### *Deployment*

The AQIP program provided a total of \$901,578 voucher dollars towards the purchase of either hybrid and \$905,308 for the emissions and fuel economy testing of at least 6 bulldozers and 6 excavators, 3 hybrid and 3 conventional of each. The testing dollars include \$183,500 paid to the participants to offset disruptions in their normal operations while the testing was being conducted.

Between September 21, 2011 and December 6, 2012 we received 16 requests for vouchers, ten for the purchase of the Cat D7E bulldozer and six for the purchase of the Komatsu HB215LC-1 excavator. The AQIP program provided funds to offset ½ the difference between the purchase price of the hybrid equipment versus the conventional equipment. Based upon information supplied by Caterpillar and Komatsu dealerships, and team members who had price quotes for hybrid and conventional equipment before the AQIP program was initiated, it was determined that the hybrid bulldozer cost ~\$150,000 more than a comparable conventional bulldozer and the hybrid excavator cost ~\$57,000 more than the conventional excavator. Therefore the voucher amounts were set at \$75,000 for the hybrid bulldozer and \$28,500 for the hybrid excavator.

**Table ES-1 Deployment dollars dispersed for the hybrid program**

Vehicle Type	Vouchers Issued	Total Voucher Funds	Average Voucher Amount	Average Equipment Purchase Price
Caterpillar Hybrid D7E Dozer	10	\$730,578	\$73,058	\$552,943
Komatsu Hybrid Hb215LC-1 Excavator	6	\$171,000	\$28,500	\$288,389
<b>Total</b>	<b>16</b>	<b>\$901,578</b>	<b>--</b>	<b>--</b>

*Activity measurements*

Activity measurements included assessing the participant’s fleet with operational records, historical usage records, and in-use data collection. For the in-use data collection, two time-lapse cameras were mounted on each unit, and a GPS and an engine control module (ECM) logger were placed in the cab; see Figure ES-3 for the Caterpillar bulldozer installation. One camera was mounted on the front of the equipment and the other on the rear. The two cameras allow views of both front and rear operations to identify the type of work being performed in both directions. The GPS was used to characterize unit speed, location, and grade. The ECM data was used to evaluate engine load and engine speed.



**Figure ES-3 Activity measurement setup on the Caterpillar D7E hybrid**

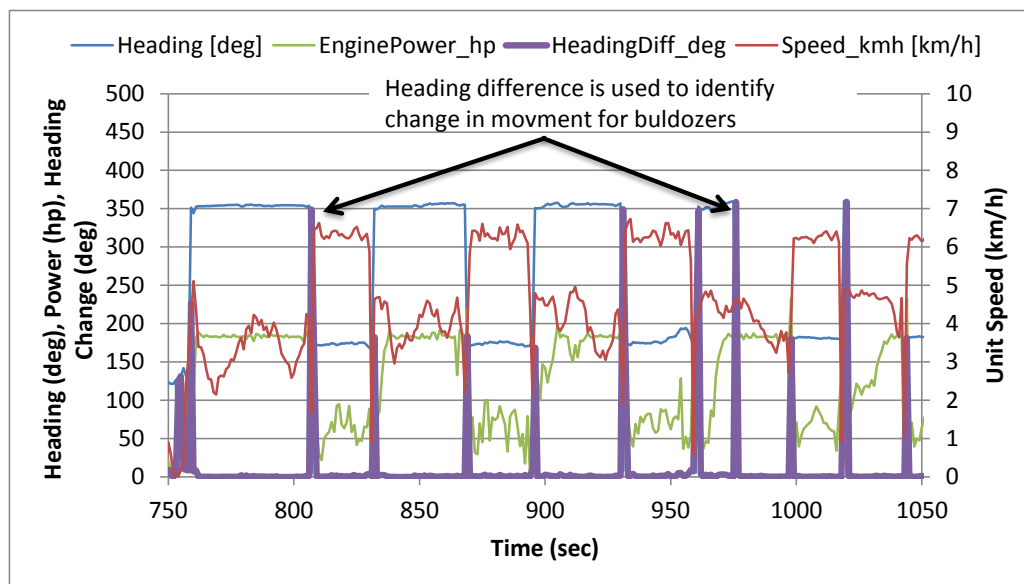
The video data was critical for determining what type of activity was being performed. For the bulldozer this activity ranged from refuse pushing, road building, rock pushing, river bed clearing, to slope repairs. For the excavator this activity ranged from compacting, dressing, trenching with 45 degrees swings, to demolition. The video data was important to the success of this project, especially for the excavator since, unlike the bulldozers, its GPS and ECM data could not be used to determine the activity it was performing. Over 2,000 hours of video data was collected for the various excavator and bulldozer units evaluated.

Additionally the ECM data was a critical factor in the development of the duty cycle and the evaluation of the in-use emissions results. Equipment manufacturer participation for ECM data was limited and UCR had to independently employ customized ECM logging tools to perform this task. In retrospect this was one of the more difficult tasks of the project. Over 160 hours of ECM second by second data was collected for each of the hybrid units. ECM fuel rate was recorded by the bulldozers during the activity study. This fuel consumption data was compared with WM records. WM maintained fuel records agreed to within 5% of UCR's in-use activity fuel usage measurements over a relatively common interval.

*Activity and duty cycle results: bulldozer*

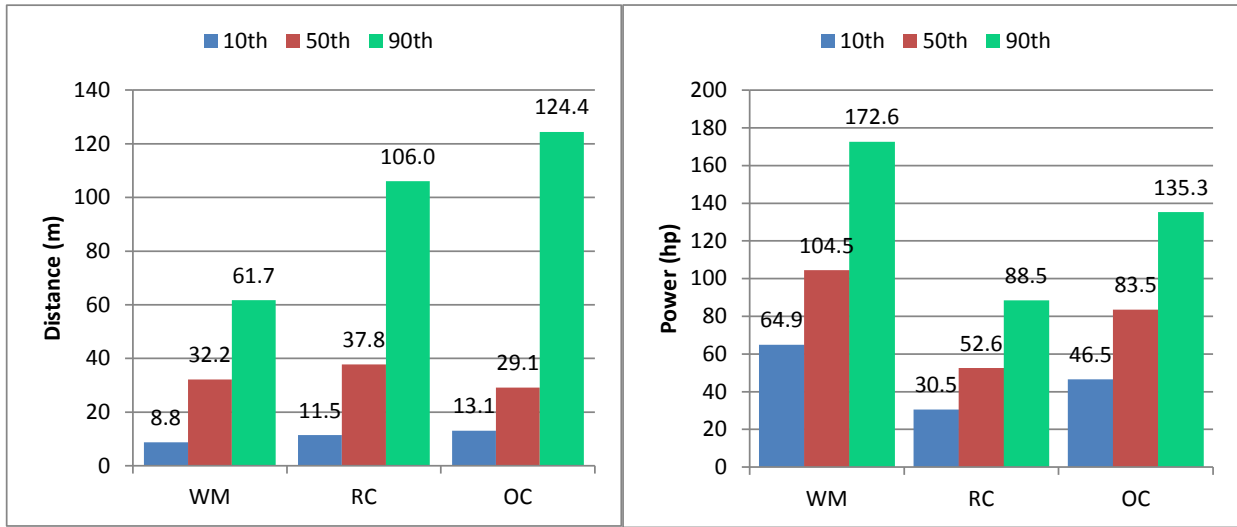
The Caterpillar bulldozer measurements were made at three different facilities, Waste Management (WM), Orange County Water District (OC), and County of Riverside Transportation Department (RC). WM represents a landfill operation, OC represents a river and lake bed maintenance operation, and RC represents a rock quarry for maintaining public roads. WM is a private fleet and OC and RC represent public fleets.

The activity data showed that bulldozer behavior is consistent with forward and backward movements. GPS heading signals can be used to identify each push/pull event, see Figure ES-4. This push/pull event was used as the main basis for the duty cycle development for the controlled pull tests. The push/pull events were analyzed using Matlab and statistical analysis was performed quantifying the unique statistics for each event. Over 130,000 events were identified between the three facilities. These events are the basis of the proposed duty cycles for evaluation of emissions results.



**Figure ES-4 Bulldozer event identification using heading change**

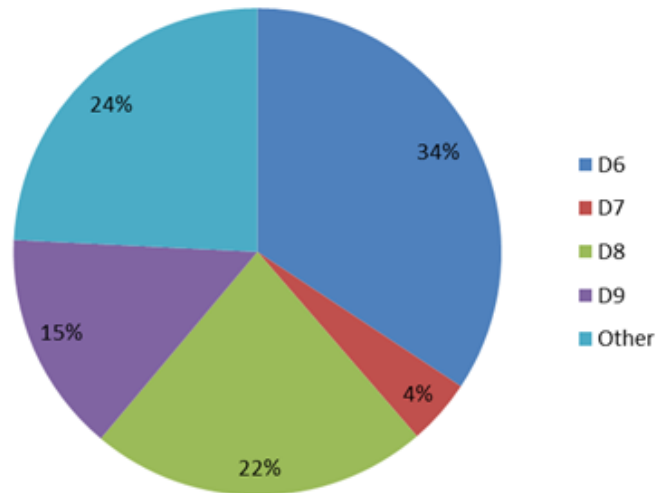
Two main metrics were found from the activity measurements that were critical for the determination of representative bulldozer operation. These are push distance and push load. Figure ES-5 shows a comparison of 10<sup>th</sup>, 50<sup>th</sup>, and 90<sup>th</sup> event statistics for each of the facilities which dominate power and distance operational modes, respectively. WM shows more power at the 10, 30, and 60 meter trips compared to OC and RC. The additional power is on the order of 50 hp or twice as much at the 30 meter push compared to RC. This suggests the type of pushes (heavy versus light) varies between facilities. The results in Figure ES-5 show that bulldozers are not always operated at full load and the load varies significantly. This variation in load does not include idle which was considered separately. Idle varied by facility and averaged approximately 10-15% of the total activity time. This idle time included time waiting for the next task (short idles 10-30 seconds long) and time with the equipment left operating for extended operation over 5 minutes.



**Figure ES-5 Activity analysis for the bulldozer push distance and engine load.**

*Emissions weighting fractions: bulldozer*

The most popular bulldozer are the D6 and D8, see Figure ES-6. The D6 is mainly used by the housing industry and the D8 is mostly used by landfills, according to local sources. The larger dozers the D9, D10 and D11 are used in large quarries, dams, major road projects, and major industrial or housing building projects. As such, it is expected that the D7E will replace D6's for commercial projects and D8's for landfills.



**Figure ES-6 Percent fraction of selected bulldozers in CA, source 2010 DOORs**

The overall weighting function recommended is based on the 50<sup>th</sup> percentile push distance of 30 meters. The load recommended is based on the operation of the land fill where higher loads were found. It is expected more load and fuel is burned by the private sector over the public sector. Thus, it is expected 90% of the emissions comes from high loaded tests and 10% comes from light loaded tests. Thus, the overall emissions benefit calculation is based on 80% full load tests at 30 meter push distances, 10% light load pushes at 30 meter distances, and 10% idle.

The D6T represents the benefit expected for general construction operations and overall implementation of the hybrid system since this is the closest like comparison. The D8T represents the benefits at landfill operations which represents a large fraction of the landfill bulldozers in CA. The D8R provides perspective on the benefit for replacement of non-ATS equipped engines.

*Emissions results: bulldozer*

The main point of this hybrid deployment and evaluation pilot project was to evaluate benefits due to the hybrid system. Benefits due to unit size, aftertreatment system, tier level, and unit capacity should not be the significant factors in the comparison. Unfortunately there were no direct like-comparisons so one must consider the intended industry the unit is being deployed for and its benefit in that application also. Thus the analysis should first consider the benefit from the hybridization and then its implementation of the hybridization as it relates to the penetration into each market category. The approach for the analysis presented in the following sections is first based on the hybridization then the equivalent replacement.

The units for comparing the emissions and fuel consumption depended on the specific type of testing that was being conducted. For the tests that were more controlled, where a specific amount of material was being moved as part of a prescribed testing protocol, the results for the different emissions components are evaluated in terms of g/hr and g/ton of material moved during the different test cycles. The in-use and in-revenue-service results are presented in terms of g/hp-hr and g/kg fuel. Since the amount of material moved during the in revenue-service varies depending on the specific unit being tested and specific task for a given test day and cannot be readily measured, comparisons between units were not done on a g/ton of material basis for the in-use and in-revenue service testing.

In summary the main overall hybrid bulldozer evaluation is primarily based on the D6T. Additionally the D8T and D8R were considered. Their evaluation was less robust compared to the evaluation of the D6T due to comparable sizes and push capabilities.

The D6T and D7E are very similar sized units that make their overall comparison straight forward, see Table ES-2 for unit comparisons. The in-use testing, in-service testing, and controlled pull testing all showed comparable emissions and performance characteristics. Thus, this suggests the controlled pull tests are a reasonable approach. The hybrids CO<sub>2</sub> emissions showed a benefit of around 15% on an overall basis, see Table ES-3. The overall benefit for the hybrids fuel consumption is based on the CO<sub>2</sub> emissions, thus the fuel consumption benefit is also around 15% overall.

The NO<sub>x</sub> emissions is not a benefit for the hybrid, but is a dis-benefit with a weighted average of 13% overall, see Table ES-3. The brake specific and fuel specific analysis confirmed the NO<sub>x</sub> dis-benefit for the in-service testing, in-use testing, and controlled pull tests for all modes. Deeper analysis from the engine lug curves showed that the engine speed range of the D7E is very narrow relative to the D6T and this may be causing the higher in-use NO<sub>x</sub> emissions.

No benefit or dis-benefit could be quantified for PM, CO, and THC due to the low emission levels from the ATS equipped engines on both the D7E and D6T units.

**Table ES-2 Hybrid and conventional unit comparisons**

Unit Model n/a	Engine Model n/a	Year n/a	Engine Hour hr	Displacement liters	Gross Power Hp	ATS n/a
D8R T2	3406E	2003	17149	14.6	348	n/a
D6T T4i	ACERT C9.3	2012	24	9.3	229	DOC/DPF
D8T T4i	ACERT C15	2012	600	15.2	348	DOC/DPF
D7E T4i	ACERT 9.3	2011	2528	9.3	252	DOC/DPF
D7E T4i	ACERT 9.3	2011	573	9.3	252	DOC/DPF

**Table ES-3 Hybrid weighted comparison to the D6T conventional**

	D7E T4i Weighted Comparison				
	CO <sub>2</sub>	NO <sub>x</sub>	PM	CO	THC
D6T-T4i	-14%	13%	n/a	n/a	n/a

<sup>1</sup> The D7E-T4i and D6T T4i are tier 4 interim bulldozers with a DPF equipped engines.

<sup>2</sup> Negative values mean hybrid benefit and positive values mean dis-benefit

The larger D8T T4i and D8R Tier 2 are not comparably sized units to the D7E which makes their overall comparison difficult and less reliable compared with the D6T vs D7E analysis. The D8 in-use testing and controlled pull testing showed the D8 engine was not operated with comparable brake specific fuel consumption to the D7E. Thus, this suggests the overall pull tests are not as representative a comparisons to the D6T analysis and that one must also weight the in-use testing results. As such the D8 analysis is less robust compared to the D6T analysis.

The overall benefit of the D7E compared to the D8T-T4i and D8R-T2 was positive for both fuel consumption and NO<sub>x</sub>. The overall hybrid fuel consumption benefit is around 23% compared to



both the D8T and D8R. The NO<sub>x</sub> emissions did show a benefit when comparing the hybrid to the D8T and D8R conventional with a weighted average of 28% and 70% overall respectively. Additional benefits were found for the hybrid over the older D8R for PM, CO, and THC which are not a result of the hybrid system, but due to the ATS systems. Additionally much of the NO<sub>x</sub> benefit listed in Table ES-4 is most likely due to differences in unit size and not the hybrid as determined from the brake specific emissions between all the units tested. Additional testing is needed to confirm the reason for the benefit hybrid compared to the D8T bulldozer.

**Table ES-4 Hybrid weighted comparison to the D8T-T4i and D8R-T2 conventional**

	D7E T4i Weighted Comparison				
	CO2	NO <sub>x</sub>	PM	CO	THC
D8T-T4i	-23%	-28%	n/a	n/a	n/a
D8R-T2	-23%	-70%	-99%	-90%	-40%

<sup>1</sup> The D7E-T4i and D8T T4i are tier 4 interim bulldozers with DPF equipped engines; the D8R-T2 is a tier 2 older bulldozer without a DPF equipped engine

<sup>2</sup> Negative values mean hybrid benefit and positive values mean dis-benefit

*Activity and duty cycle results: excavator*

Activity information on the excavators was obtained via interviews with expert participants and via direct measurement of video, engine, and GPS data. The expert opinions and feedback helped focus the direct measurements and fill data holes left due to the relatively small sample size of the direct measurements. Directly measured activity data was recorded at three project sites: a construction site at Ft. Hunter Liggett, a demolition site in Escondido, and another construction site in Lancaster.

Three models of excavator were monitored for this project: the hybrid model (HB215LC-1) and two conventional models: one about the same size as the hybrid (PC200) and the other slightly larger than the hybrid (PC220). The PC200 was considered by Komatsu to be the most direct competitor to the hybrid in their fleet. The slightly larger PC220 model was added at the suggestion of participants since they considered the HB215LC-1 to be a viable alternative to the PC220 and they are much more prevalent in the statewide fleet. All three models were certified to Tier 3 standards.

By manually reviewing the excavator video data, modes of work were assigned, along with date and time of day each mode occurred/changed. Synchronizing the video mode data with ECM data allowed the statistical analysis of engine load along with work mode. That analysis allowed UCR to consolidate over 15 work modes identified in the video into 7 that would adequately characterize in-use excavator emissions. The test modes were assembled into an emissions test cycle as described in Table ES-4, below.

**Table ES-4 Excavator emissions test - modal description**

Test Order	Mode Name	Description
	Prepare for Travel	Move to start position. Make sure excavator is in "Power" mode.
1	Travel	Travel back and forth three times, 100 yards in each direction. Use "Slow" speed setting the first lap, "Medium" the second, and "Fast" the third. Turn as normal for operator at each end.
	Prepare for Trench 45	Idle for 30 - 60 seconds. Move to start for next mode. Idle for 20 - 30 seconds.
2	Trench 45	Dig a level trench 1 bucket wide & 4 to 5 feet deep for 8 minutes. Swing 45° & drop spoils in a row on one side. Clean the top sides as you go for safety.
	Prepare for Trench 90	Idle for 30 - 60 seconds. Move to start for next mode. Idle for 20 - 30 seconds.
3	Trench 90	Dig a level trench 1 bucket wide & 4 to 5 feet deep for 8 minutes. Swing 90° & drop spoils in a row on one side. Clean the top sides as you go for safety.
	Prepare for Trench 180	Idle for 30 - 60 seconds. Move to start for next mode. Idle for 20 - 30 seconds.
4	Trench 180	Dig a level trench 1 bucket wide & 4 to 5 feet deep. Swing 180° & drop spoils in a pile behind. Clean the top sides as you go for safety. Stop when the treads start to climb the spoils pile (about 6 minutes).
	Prepare for Dress	Idle for 30 - 60 seconds. Swing 180 degrees to dress the spoils from the "Trench 180" mode.
5	Dress	Using a pre-determined technique that is natural to the operator, dress the "Trench 180" spoils pile evenly down to a level of about 1 foot high. Stop when the entire pile is done.
	Prepare for Backfill	Idle for 30 - 60 seconds. Travel back to the "Trench 45" spoils row. Idle for 20 - 30 seconds.
6	Backfill	Using a pre-determined technique that is natural to the operator, backfill the "Trench 45" trench using the spoils that came from it. Stop when the trench is level to the ground.
7	Idle	The data for this mode will be assembled during post processing from the times in between modes 1 through 6.

By analyzing what fraction of engine time each of the 7 modes represented and through further input from expert participants and Komatsu, UCR estimated a preliminary, statewide weighting for the emissions from each of the work modes. This weighting was used later to calculate a state-average emissions benefit or dis-benefit of using the hybrid instead of one of the conventional excavators.

*Emissions weighting fractions: excavator*

In the 2010 DOORS database there are 11,823 excavators in California with model years ranging from 2008 to 1945. The manufacturers include Caterpillar (42%), Komatsu (10%), Deere (9%), Hitachi (8%), with the remaining 31% distributed amongst many manufacturers. Of these excavators, about 14% (1,622) have horsepower in the range of 150 to 200. The distribution by manufacturers in this horsepower range is shown in Figure ES-7, where it can be seen that the Komatsu PC200 and Komatsu PC220 account for 7%. While Komatsu compares the HB215LC-1 hybrid with the PC200, users have indicated they would consider replacing the PC220 with the HB215LC-1 hybrid. There are 3.4 times as many PC220's as there are PC200's so emission comparisons were made between the PC220 as well as the PC200.

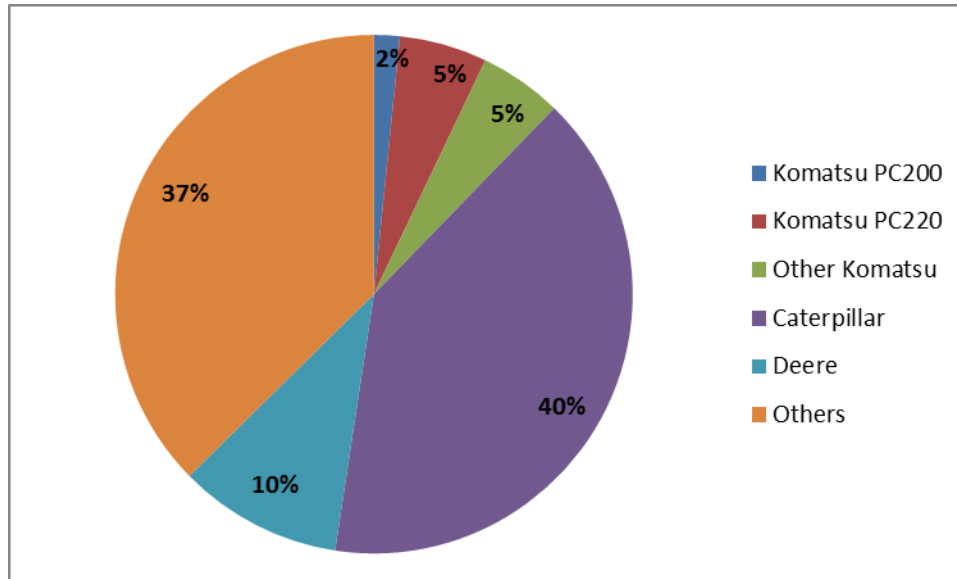
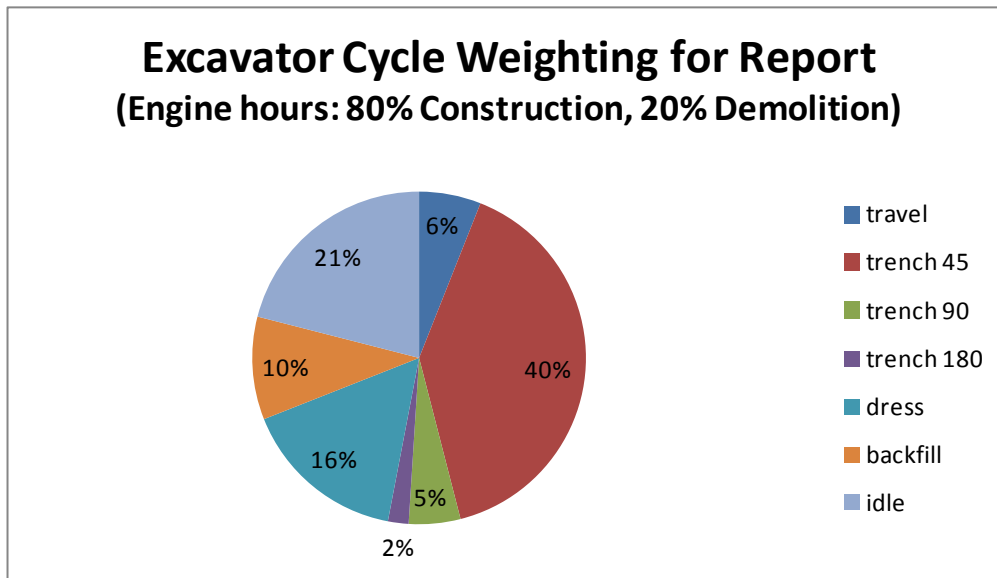


Figure ES-7 Percentage of Excavators in the 150 to 200 hp range

The weighting function for the final overall analysis of the excavator comparison is based on measured activity data and interviews with stakeholder such as local dealers, project participants, and the manufacturer. The estimates of the fraction of calendar time for these types of operations was closer to 10% demolition, but we observed in the activity data that a much larger fraction of the work day was spent with the engine on for demolition projects than for construction projects. This resulted in our increasing the fraction for engine-on time to 20% demolition. The resulting calculations and results are shown below in Figure ES-8.



**Figure ES- 8 Estimated state-wide mode fractions**

*Emissions results: excavator*

Three hybrid models (HB215LC-1), two PC200 conventional models and two PC220 conventional models were tested and inter-compared in this project. Table ES-5 below summarizes information about those excavators.

**Table ES-5 Excavator test units, owners, and test operators**

Test Sample ID - long	HB215 DD	PC200 DD	HB215 RM	PC220 DD	PC220 CE	HB215 CE	PC200 RM
Test Sample ID -short	H1DD	C1RM	H2RM	C2DD	C3CE	H3CE	C4RM
Excavator Type	Hybrid	Convntnl	Hybrid	Convntnl	Convntnl	Hybrid	Convntnl
Model	HB215	PC200	HB215	PC220	PC220	HB215	PC200
Owner	RoadMach	RoadMach	DiamondD	Harrison	Clairemont	Clairemont	RoadMach
StateID	DU4Y75	GF3H79	AG8G48	YF3H64	TE4E84	HL4J84	??B37
Test Date	2/28/2013	3/1/2013	3/12/2013	3/13/2013	3/20/2013	3/21/2013	3/21/2013
Test Location	Woodland	Woodland	Woodland	Woodland	Escondido	Escondido	Escondido
Test Operator	DiamondD-1	DiamondD-1	DiamondD-2	DiamondD-2	Clairemont-2	Clairemont-2	Clairemont-2

Note: Data produced by operator "Clairemont-1" was not analyzed due to his extreme inexperience.

Table ES-6 summarizes the weighted final results of the comparison between the hybrid and the PC200 excavator. Since Komatsu considers the PC200 to be the most directly comparable excavator to the hybrid, comparisons to the PC220 are not explicitly discussed in the executive summary, however; the relative benefits are larger and where dis-benefits exist, they are smaller than those seen in the comparison to the PC200.

**Table ES-6 Weighted relative benefit of using the HB215**

HB215 % Change Compared to PC200				
CO2	NOx	PM	THC	CO
-16%	1%	27%	-70%	8%

<sup>1</sup> negative value means HB215 emitted less than PC200

<sup>2</sup> calc'd using best guess of the typical operating mode mix